



swiss tech concept SAAR

PROFILES LEDS

CATALOGUE 2024

Plus de 120 modèles de profilés LED



Pour créer vos ambiances

Les possibilités sont infinies

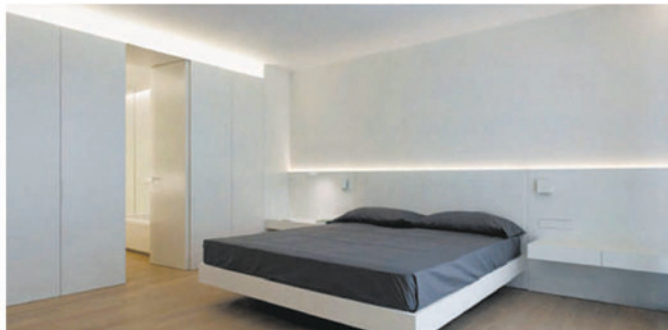

Nouvelles gammes de profilés noir



Une qualité
sans compromis



Les alimentations que nous avons sélectionné, sont garanties 5 ans et répondent aux normes les plus élevées.

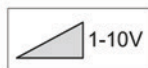

Nos profiles sont usinés en Europe - Normes d'extrusion ISO 9001:2008 / Tolérance selon norme : UNE-EN 755-9 / UNE-EN 12020-2
Aluminium pureté 95-98% / traitement T-5 anodisation 15 microns / diffuseur traitement anti-feu V0

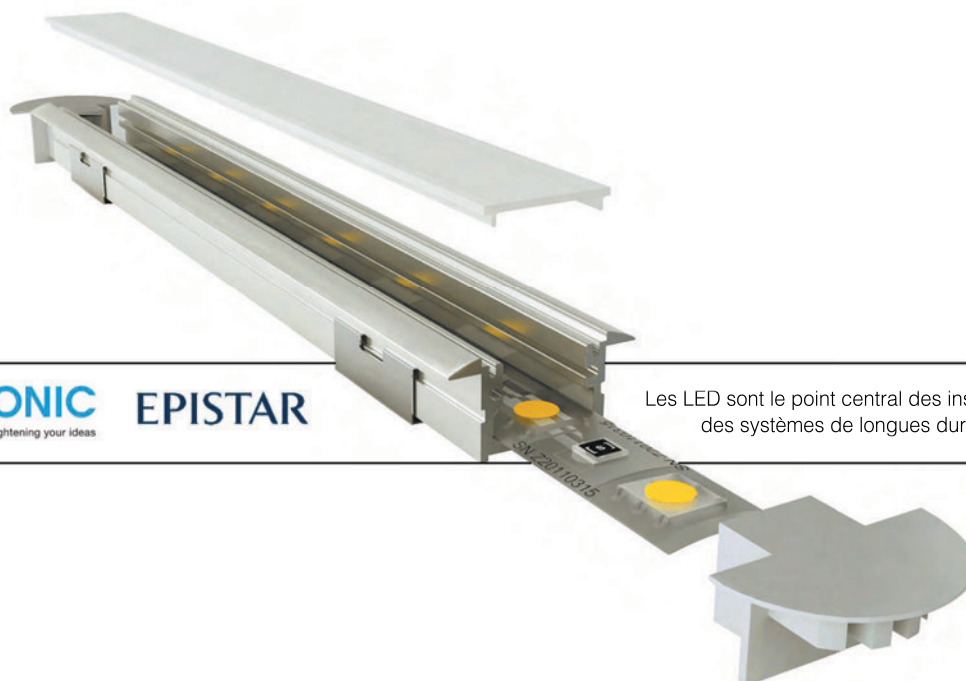

Les LED sont le point central des installations, nous avons choisis des systèmes de longues durées, avec un haut rendement.

Profils apparents

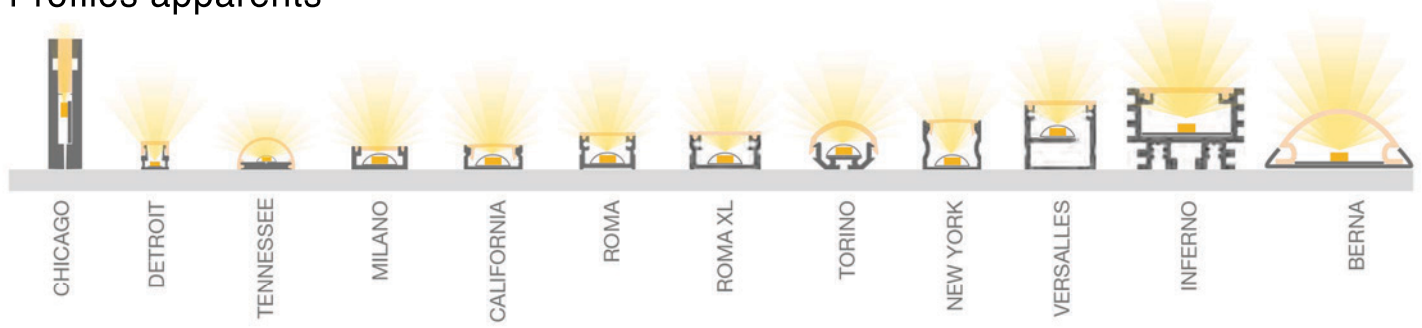

Profils d'angles

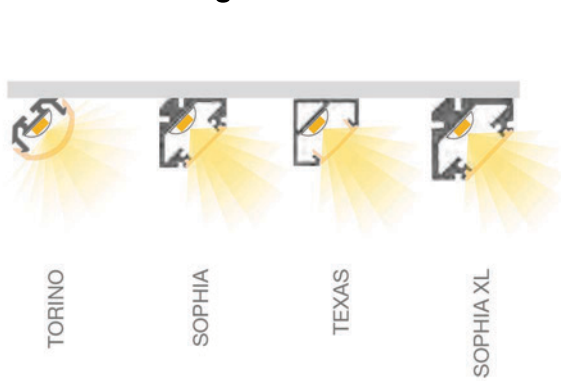

Profils encadrés

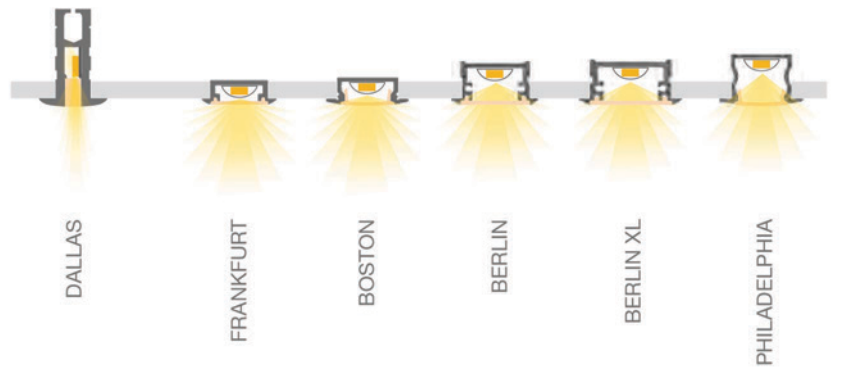

Profils de sols

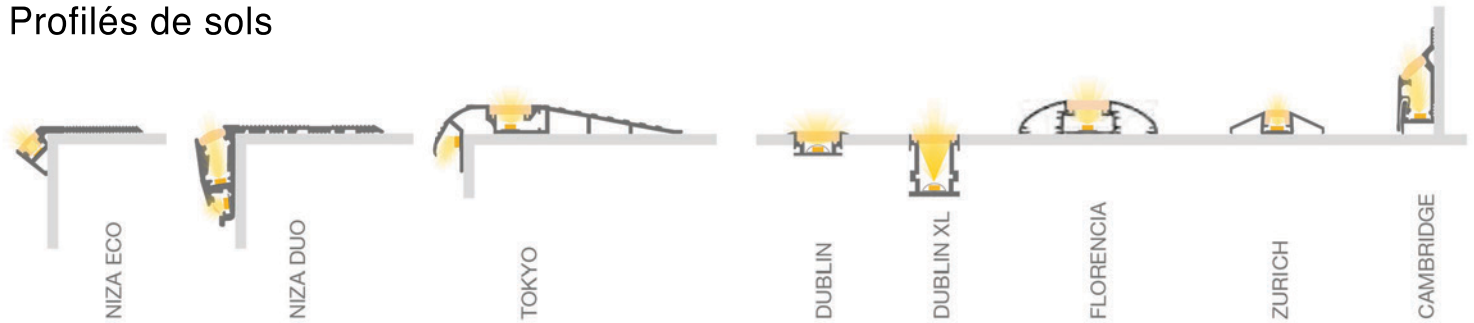

Profils muraux

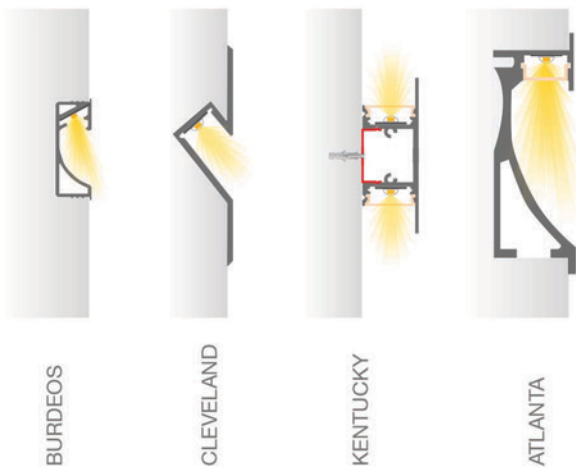

Profils techniques

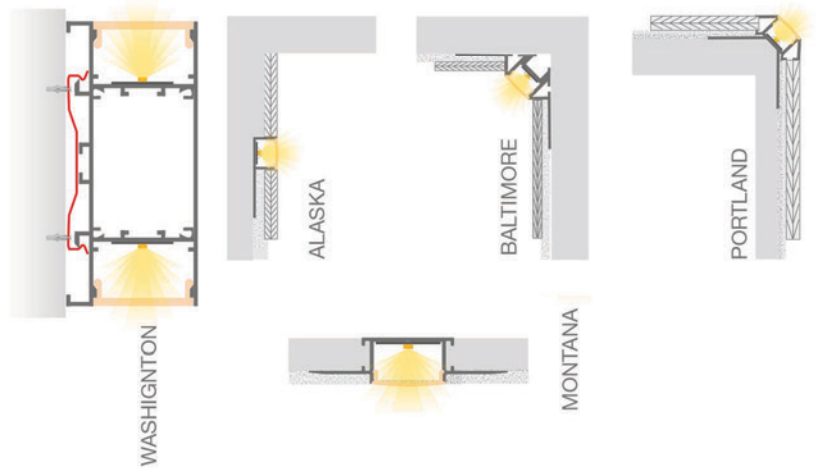

Profils flexibles

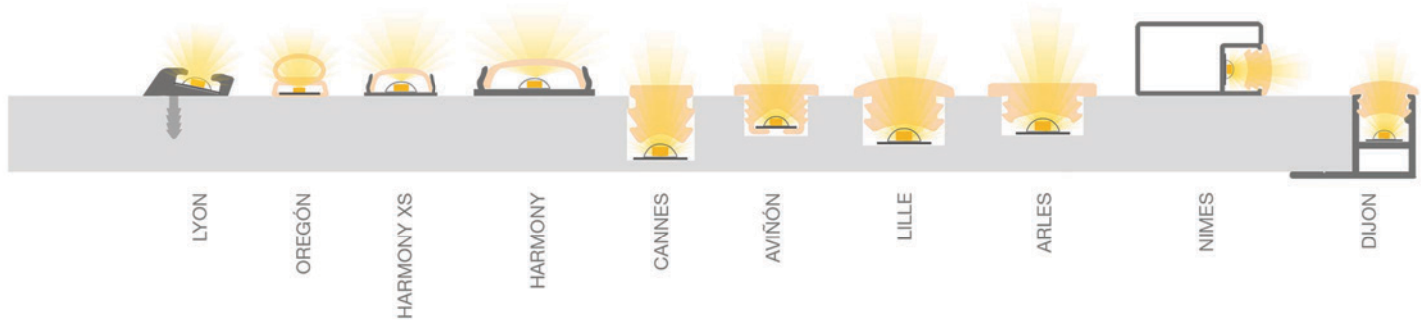

Structures apparentes

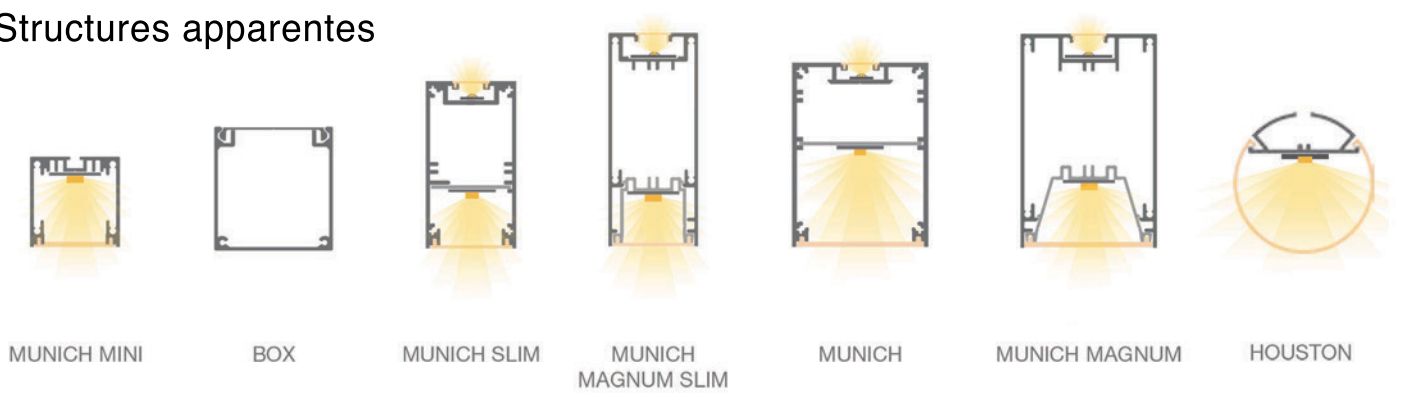

Structures encastrées

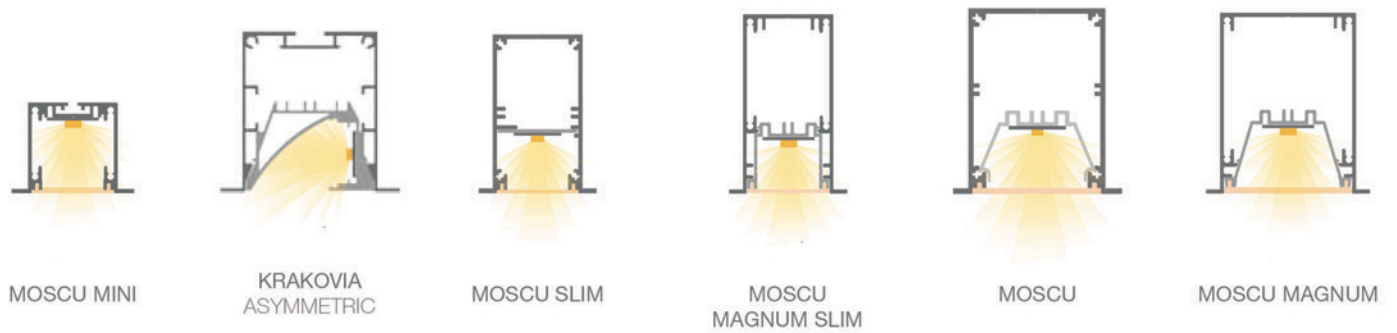

Structures suspendues

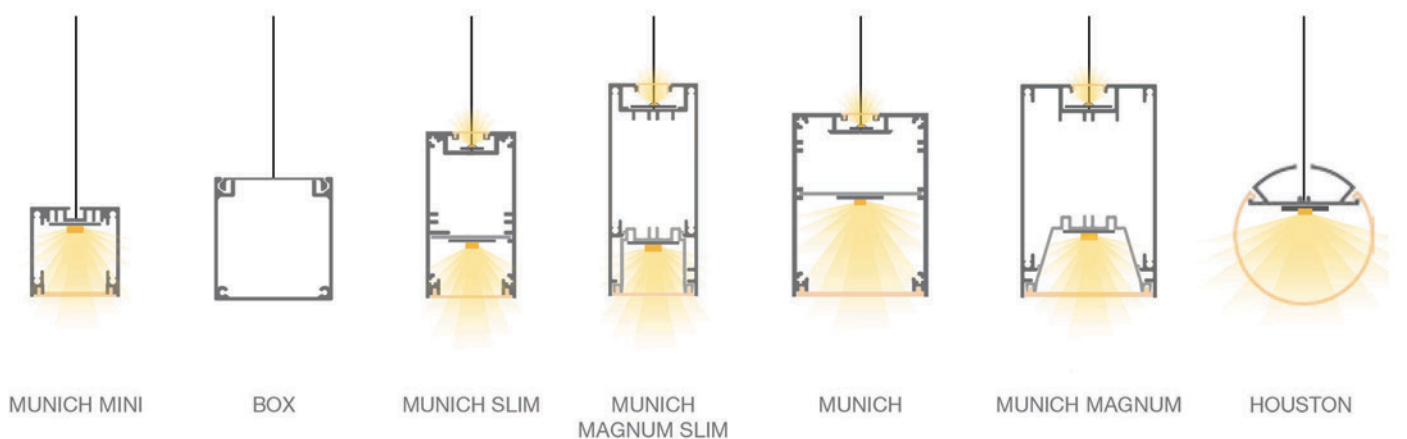

**Profils
apparents**





Profilé aluminium anodisé:
01.013 2m



Diffuseur Méthacrylate:
18.019 opale 2m



Embout plastique:
19.011 avec passage de câble



Clips inox:
20.006



Pièce orientable:
20.004 (Clips inox non inclus)

MAX
16W/m





Profilé aluminium anodisé:

01.001 2m

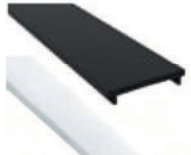

Profilé aluminium noir:

01.002 2m



Diffuseur polycarbonate:

18.001 transparent 2m

18.002 opale 2m

18.007 noir 2m



Embout plastique:

19.001 sans passage de câble

19.002 avec passage de câble

19.003 sans passage de câble noir

19.004 avec passage de câble noir



Angle 90°:

22.001 52x13mm

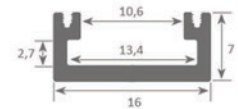
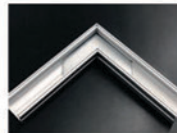

Sur demande: - profilé inox
- longueur 3m
- lentille 60°
- diffuseur IK10

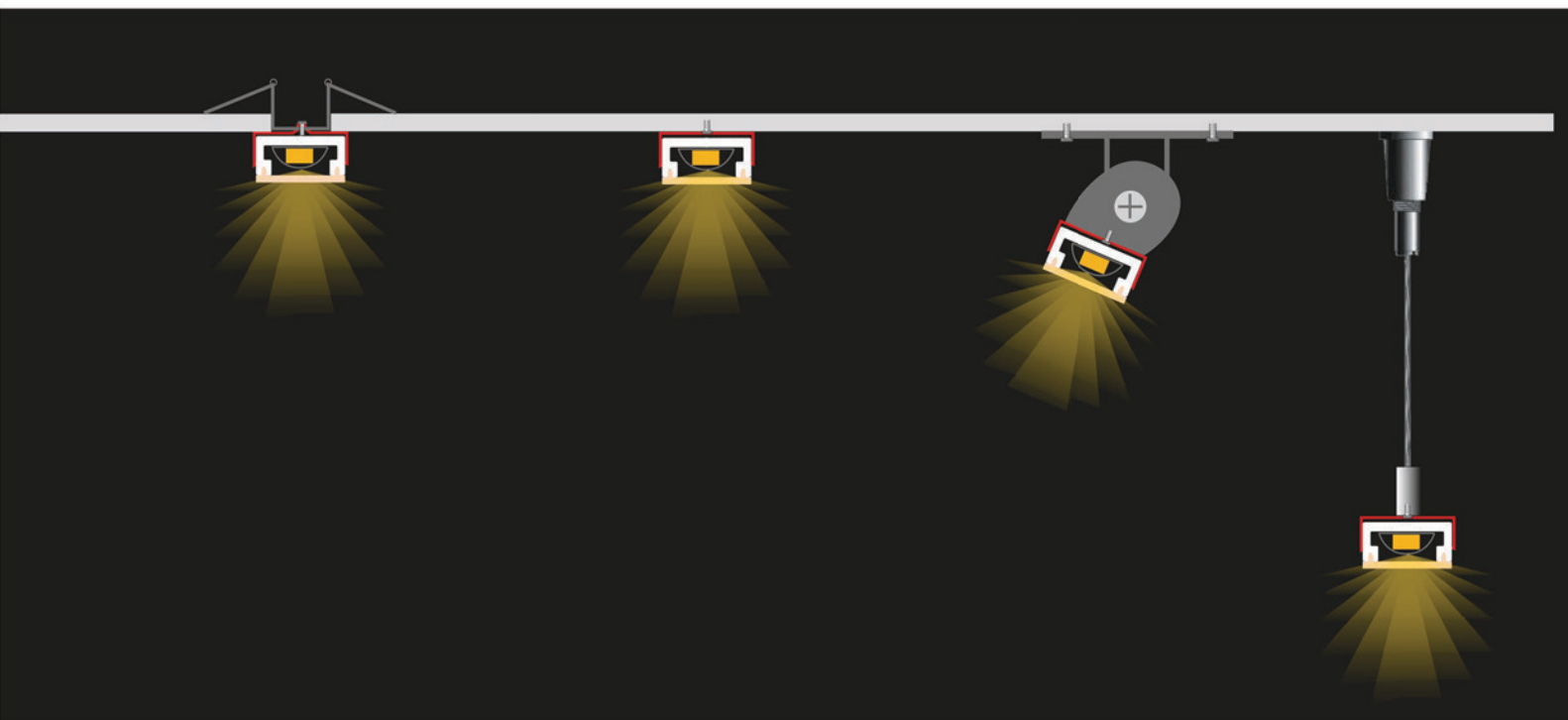

Pièce encastré :

20.003
(clips inox non inclus)

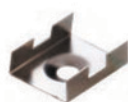

Clips inox :

20.001
20.002 noir



Pièce orientable :

20.004
(clips inox non inclus)



Suspension acier :

21.006



Profilé aluminium anodisé:
02.001 2m



Profilé aluminium noir:
02.002 2m



Diffuseur polycarbonate:
18.001 transparent 2m
18.002 opale 2m
18.007 noir 2m



Embout plastique:
19.016 sans passage de câble
19.017 avec passage de câble
19.018 sans passage de câble noir
19.019 avec passage de câble noir



Angle 90°:
22.001 52x13mm

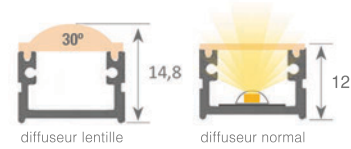
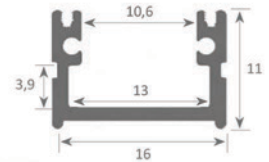
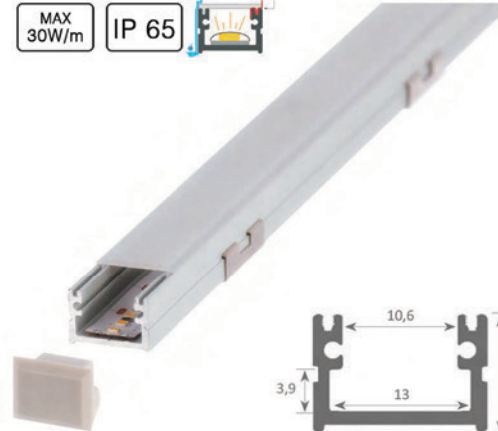

Sur demande: - profilé inox
- longueur 3m
- lentille 30°
- diffuseur IK10



Pièce encastrée:
20.003
(Clips inox non inclus)

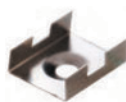

Clips inox:
20.007
20.008 noir



Pièce orientable:
20.004
(Clips inox non inclus)



Suspension acier:
21.007

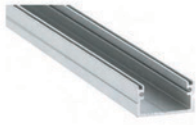

Profilé aluminium anodisé:
02.007 2m

MAX
35W/m

IP 65



Diffuseur polycarbonate:
18.022 transparent 2m
18.023 opale 2m



Diffuseur carré:
18.032 opale 2m

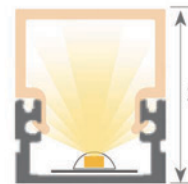
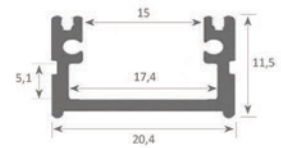

Embout plastique:
19.022 sans passage de câble
19.023 avec passage de câble

Sur demande: - longueur 3m
- lentille 60°
- profilé noir
- diffuseur noir



Embouts plastique:
19.026 blanc pour diffuseur carré



Pièce encastrée:
20.003
(Clips inox non inclus)

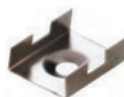

Clips inox:
20.009



Pièce orientable:
20.004
(Clips inox non inclus)



Suspension acier:
21.008

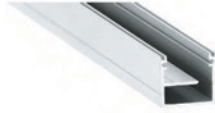

Profilé aluminium anodisé:
02.018 2m

MAX 35W/m IP 65



Profilé aluminium noir:
02.019 2m



Diffuseur polycarbonate:
18.022 transparent 2m
18.023 opale 2m
18.028 noir 2m



Embout plastique:
19.034 sans passage de câble
19.293 noir sans passage de câble



Embout pour diffuseur carré noir:
19.035 sans passage de câble blanc
19.036 sans passage de câble noir



Clips inox:
20.009
20.010 noir



Pièce encastrée:
20.003 (Clips inox non inclus)



Pièce orientable:
20.004 (Clips inox non inclus)

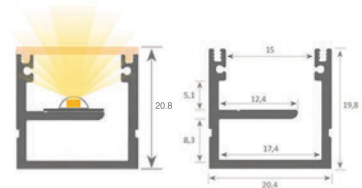

Sur demande: - longueur 3m
- lentille 60°

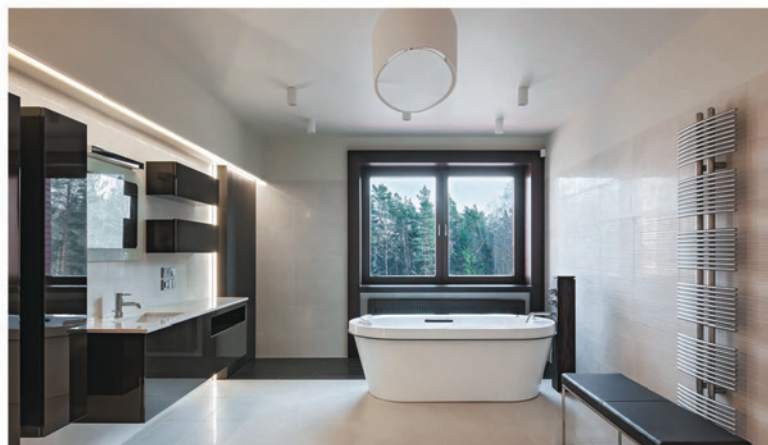
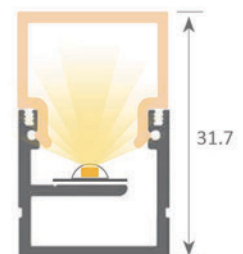
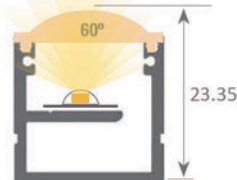
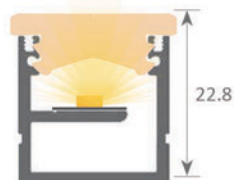
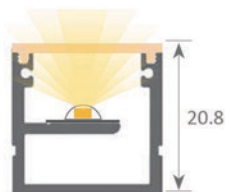



Profilé aluminium blanc:
02.028 2m



Diffuseur méthacrylate:
18.040 opale 2m



Embout plastique:
19.286 méthacrylate opale

MAX
35W/m

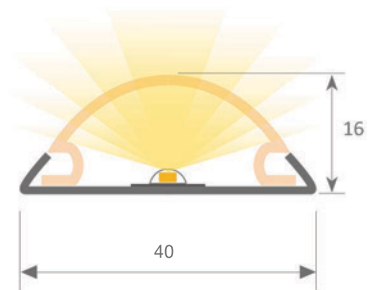



Profilé aluminium anodisé:
01.015 1m



Diffuseur Méthacrylate:
18.021 opale 1m
Nous recommandons pour une installation facile, la fixation du diffuseur avec du ruban adhésif double face



Embout plastique:
19.014 sans passage de câble
19.015 avec passage de câble



Vis acier:
22.002

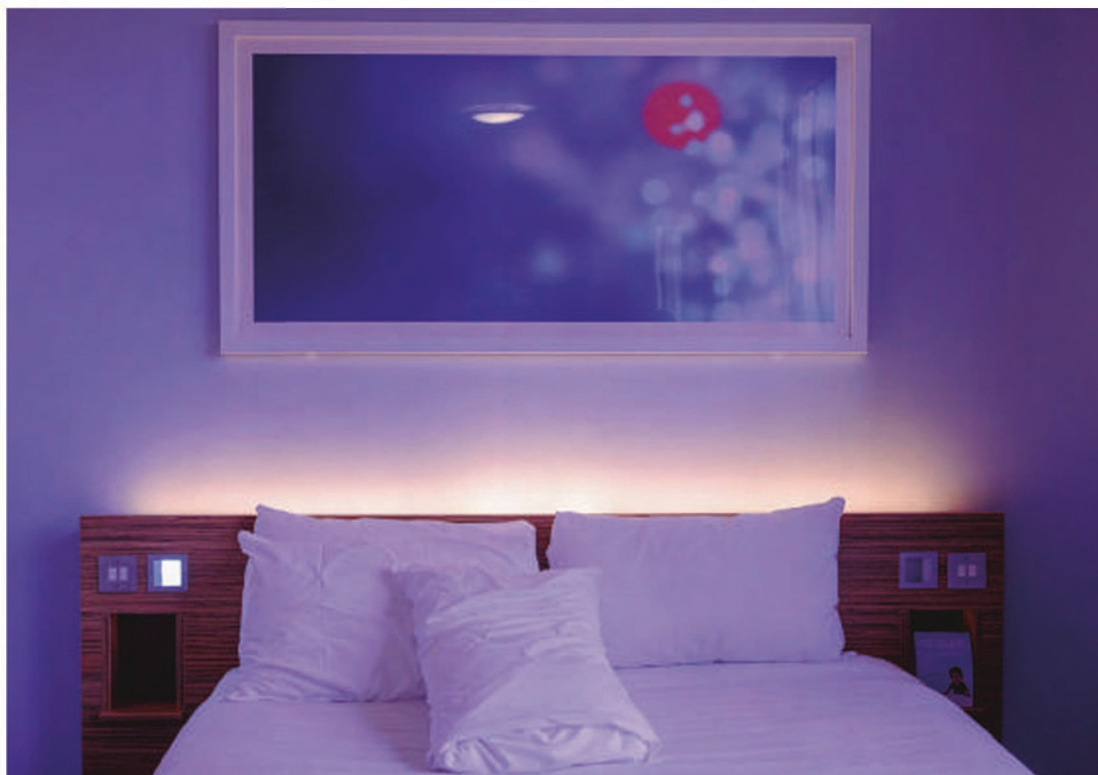
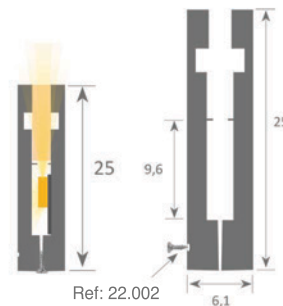



Profilé aluminium anodisé:
02.026 2m



Diffuseur méthacrylate:

18.036 angle 30° 2m

18.037 angle 60° 2m

18.038 angle 90° 2m

18.039 opale 2m

30° 60° 90°



Embout aluminium:

19.045 angle 30°

19.046 angle 60°

19.047 angle 90°

également pour
diffuseur opale



Clips plastique transparent:
20.014

MAX
30W/m

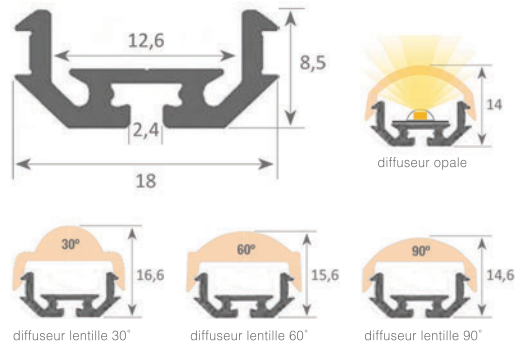

Sur demande: - longueur 3m





Profilé aluminium anodisé:
13.001 2m



Profilé aluminium noir:
13.002 2m



Diffuseur polycarbonate:
18.001 transparent 2m
18.002 opale 2m
18.007 noir 2m

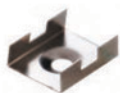

Embout plastique:
19.083 sans passage de câble
19.084 avec passage de câble
19.085 noir sans passage de câble
19.086 noir avec passage de câble

Clips inox:
20.007
20.008 noir



Kit de suspension:
21.001 acier
21.003 noir
21.002 blanc

MAX 30W/m

IP 65

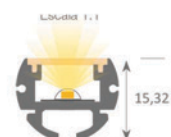
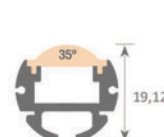
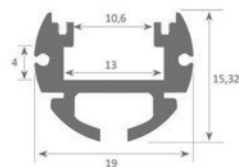

Sur demande: - longueur 3m
- lentille 35°

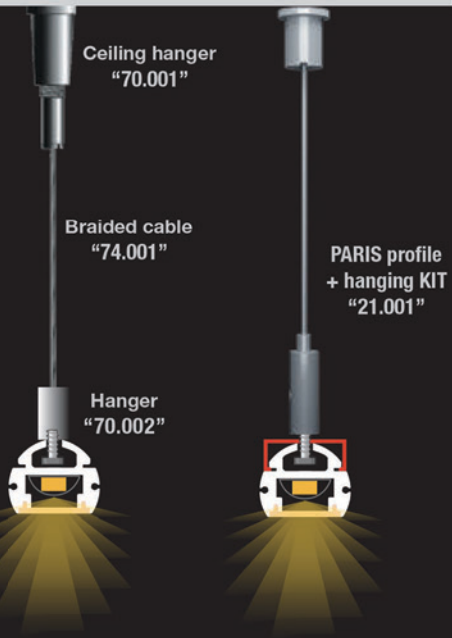
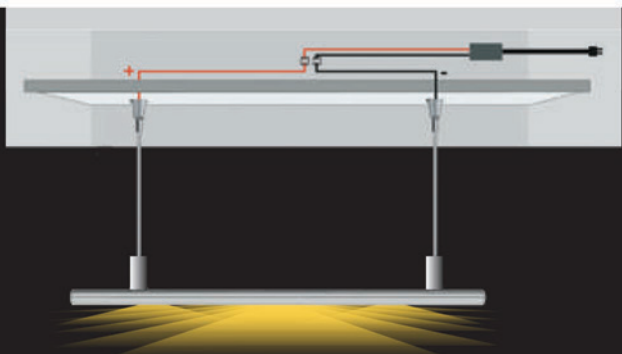

PARIS profile + surface bracket "20.007"



PARIS profile + support "22.008"

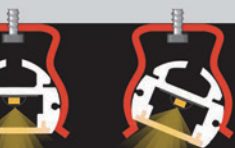

PARIS profile + bracket "20.019"

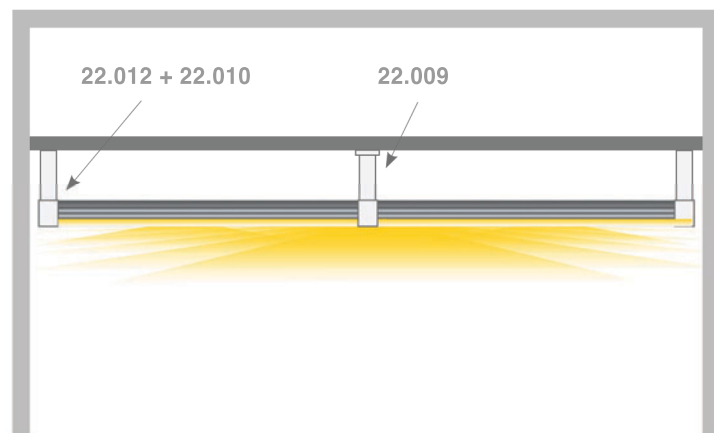
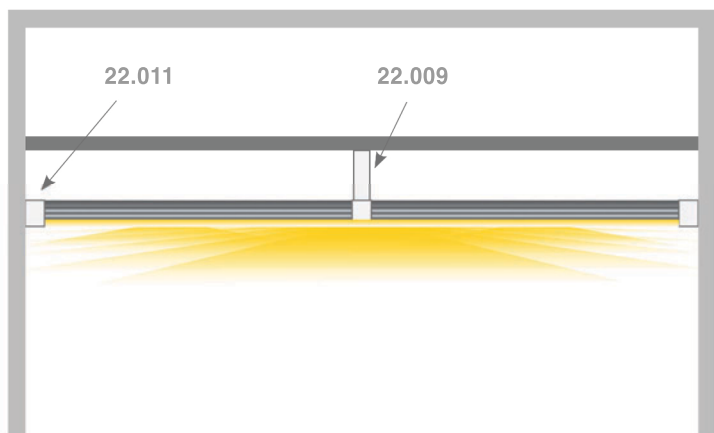

Support central:
22.009 aluminium



Support latéral:
22.010 aluminium



Support mural:
22.011 aluminium



Extrémité:
22.012 aluminium

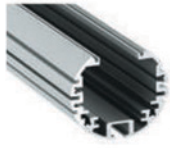

Profilé aluminium anodisé:

13.013 2m

Profilé aluminium noir:

13.015 2m



Diffuseur polycarbonate:

18.022 transparent 2m

18.023 opale 2m

18.028 noir 2m



Embout aluminium:

19.095 gris

19.096 noir



Platine interne:

22.013 aluminium 2m



Jonction linéaire:

22.005 acier



Jonction 90°:

22.003



Jonction 120°:

22.004



Bras de support:

22.006 aluminium 170x50mm
(clips non inclus)

22.007 noir 170x50mm
(clips non inclus)

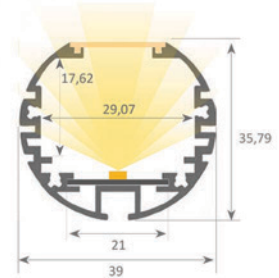

Sur demande: - longueur 3m



21.001 + 20.021



Clips:

20.021 inox

20.020 polycarbonate transparent



Kit de suspension:

21.001 acier

21.003 noir

21.002 blanc

Profilés d'angles





Profilé aluminium anodisé:

05.001 2m



Profilé aluminium noir:

05.002 2m

Diffuseur polycarbonate:

18.001 transparent 2m

18.002 opale 2m

18.007 noir 2m



Embout plastique:

19.065 sans passage de câble

19.066 avec passage de câble

19.067 noir sans passage de câble

19.068 noir avec passage de câble



Clips inox:

20.015

20.016 noir



Suspension acier :

21.011

MAX 30W/m IP 65

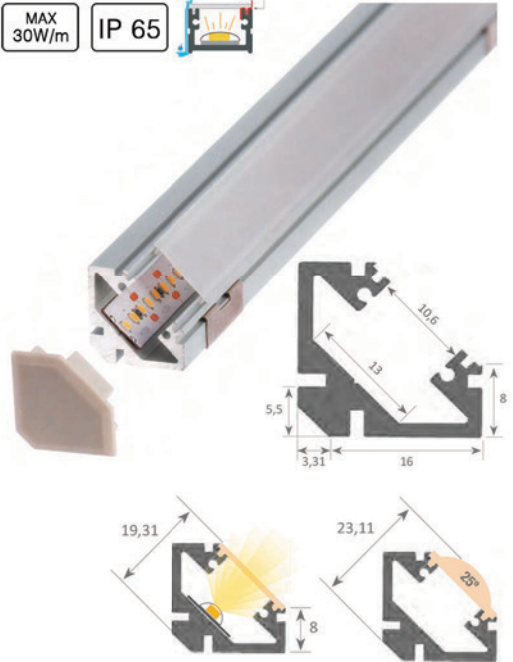

Sur demande: - longueur 3m
- lentille 25°





Profilé aluminium anodisé:
05.011 2m

MAX 35W/m IP 65



Diffuseur polycarbonate:
18.022 transparent 2m
18.023 opale 2m

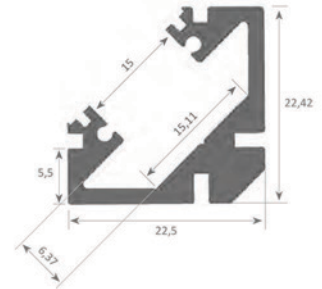

Embout plastique:
19.071 sans passage de câble
19.072 avec passage de câble

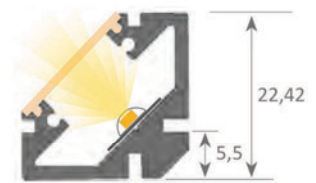

Clips inox:
20.012

Sur demande: - longueur 3m
- lentille 40°



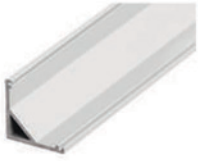

Profilé aluminium:
05.021 3m

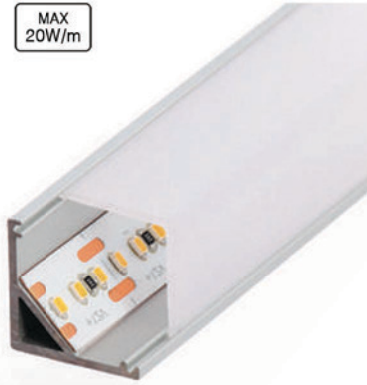

Diffuseur polycarbonate:
18.042 opale 3m

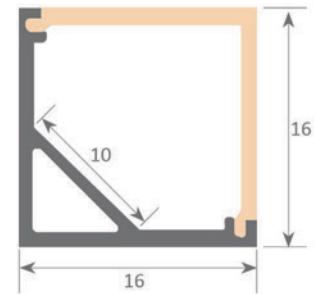

Embout plastique:
19.078 sans passage de câble
19.077 avec passage de câble



Clips plastique:
20.018



Split



Profilé aluminium:
05.021 3m



Diffuseur polycarbonate:
18.043 opale 3m

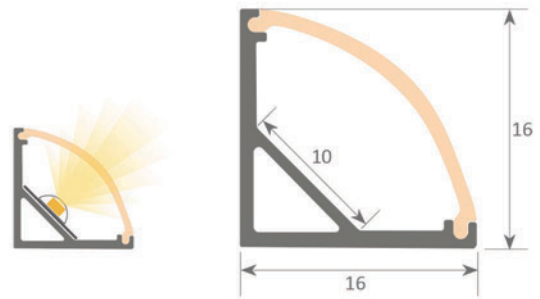

Embout plastique:
19.080 sans passage de câble
19.079 avec passage de câble



Clips plastique:
20.018

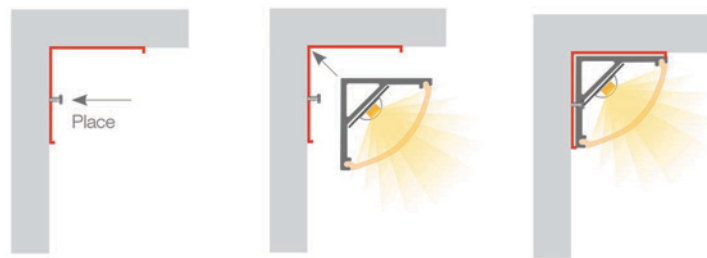





Profilé aluminium anodisé:

03.001 2m

Profilé noir:

03.002 2m



Diffuseur polycarbonate:

18.001 transparent 2m

18.002 opale 2m

18.007 noir 2m

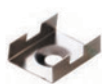

Clips acier:

20.001

20.002 noir



Embout plastique:

19.048

19.049 noir

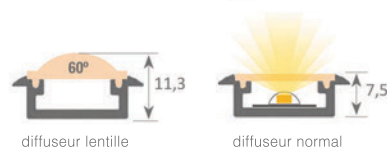

diffuseur lentille

diffuseur normal

Sur demande: - longueur 3m
- lentille 60°





Profilé aluminium anodisé:

04.001 2m



Profilé aluminium noir:

04.002 2m



Diffuseur polycarbonate:

18.001 transparent 2m

18.002 opale 2m

18.007 noir 2m



Clips inox:

20.007

20.008 noir



Embout plastique:

19.055

19.056 noir

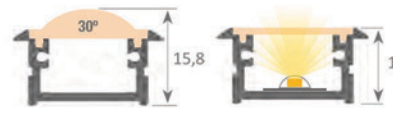
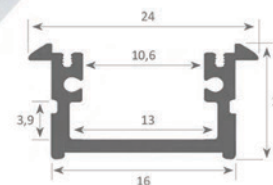

diffuseur lentille

diffuseur normal

Sur demande: - longueur 3m
- lentille 30°

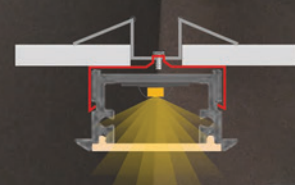



Profilé aluminium anodisé:
04.005 2m



Diffuseur polycarbonate:
18.022 transparent 2m
18.023 opale 2m



Diffuseur carré:
18.032 opale 2m



Embouts plastique:
19.026 blanc



Embout plastique:
19.060 gris avec passage de câble
19.059 gris sans passage de câble



Clips inox:
20.009

MAX
15W/m

IP 65

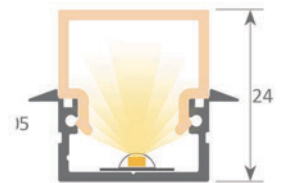
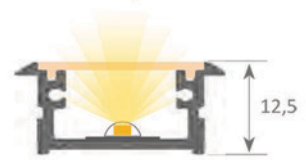
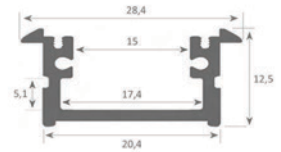

Sur demande: - longueur 3m
- lentille 60°

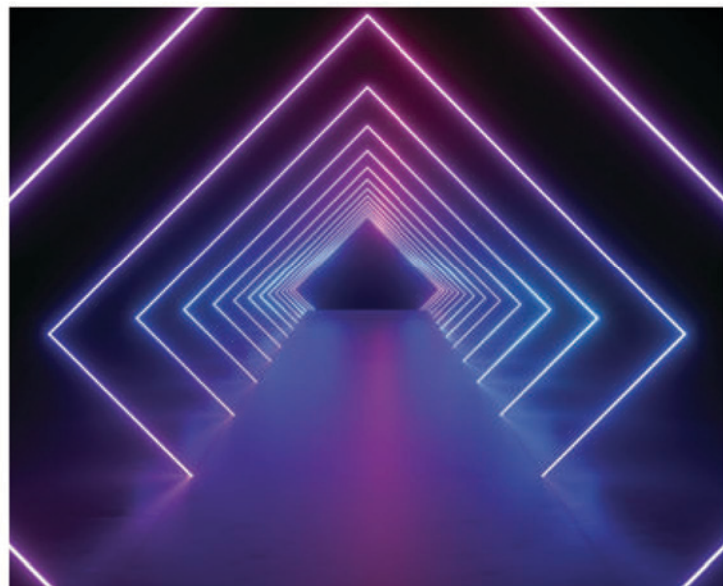

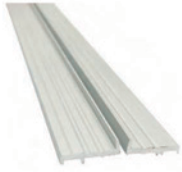

Profilé aluminium anodisé:
03.011 2m (set de 2 pièces)



Diffuseur méthacrylate:
18.041 opale 1m
Nous recommandons pour une installation facile, la fixation du diffuseur avec du ruban adhésif double face

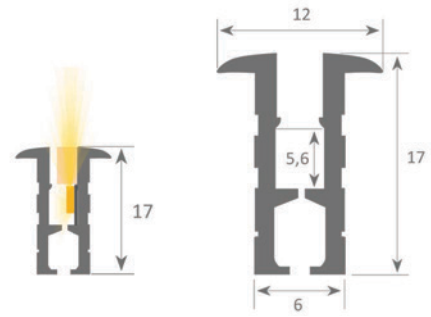
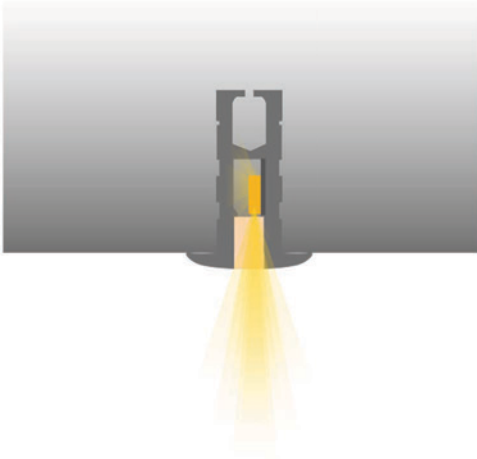

Profils de sols





Profilé aluminium anodisé:
07.001 2m



Diffuseur polycarbonate IK10:
18.012 opale 2m



Embout aluminium:
19.116



Résine époxy:
22.018 1kg

MAX
20W/m

IP 65

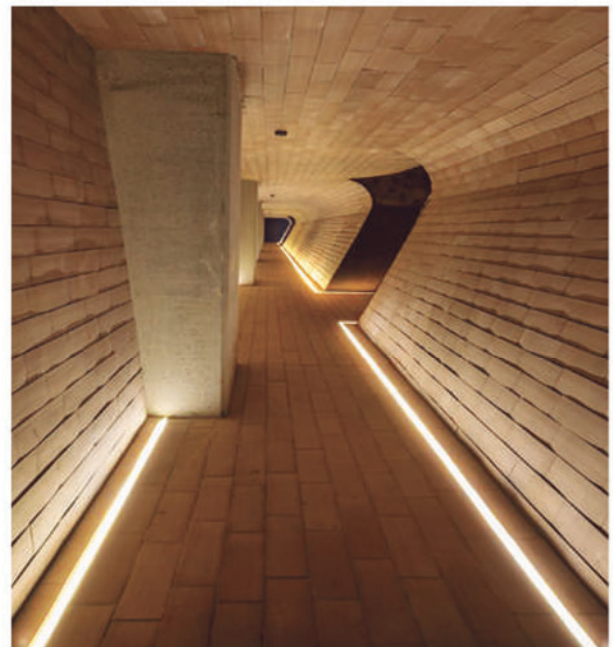
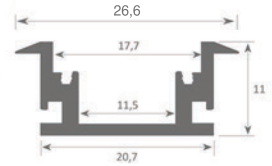
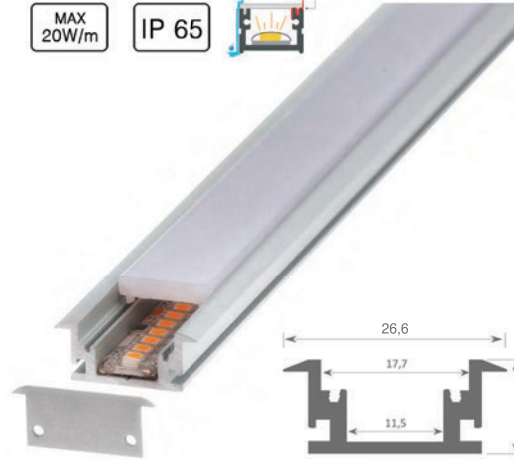



Profilé aluminium anodisé:
07.003 3m



Diffuseur polycarbonate IK10:
18.053 opale 3m



Platine interne:
22.019 aluminium 2m



Embout plastique:
19.117 avec passage de câble
19.118 sans passage de câble



Résine époxy:
22.018 1kg

MAX
30W/m

IP 65

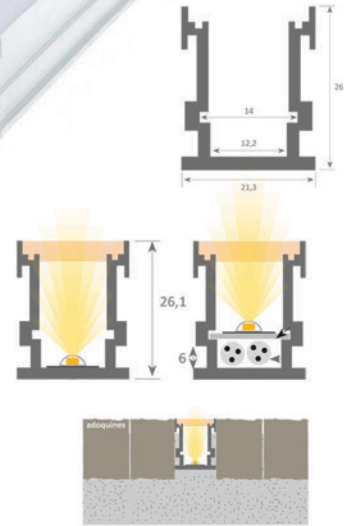
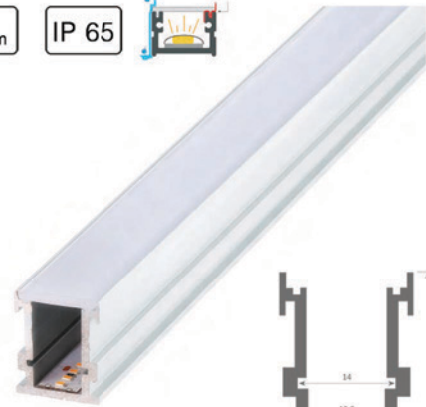



Profilé aluminium anodisé :
07.004 anodisé 2m

MAX
40W/m IP 65



Diffuseur méthacrylate IK10:
18.012 opalé 2m



Embout aluminium :
19.119 aluminium
sans passage de câble
19.120 plastique gris
sans passage de câble
19.121 plastique gris
avec passage de câble



Plaque inférieure isolante:
22.020 aluminium

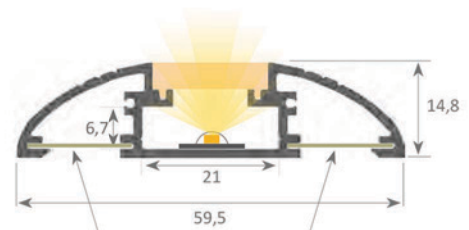

Plaque isolante "facultatif"

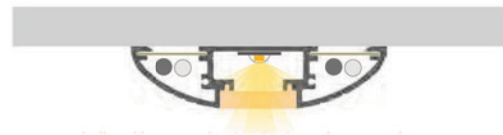

Application comme luminaire plafonnier extra-plat

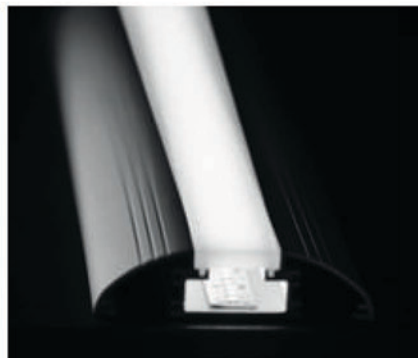

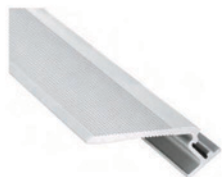

Profilé aluminium anodisé:
06.001 2,40m



Diffuseur:
18.045 opale 1m



Embout plastique:
19.109 gris (set de 2 pièces)

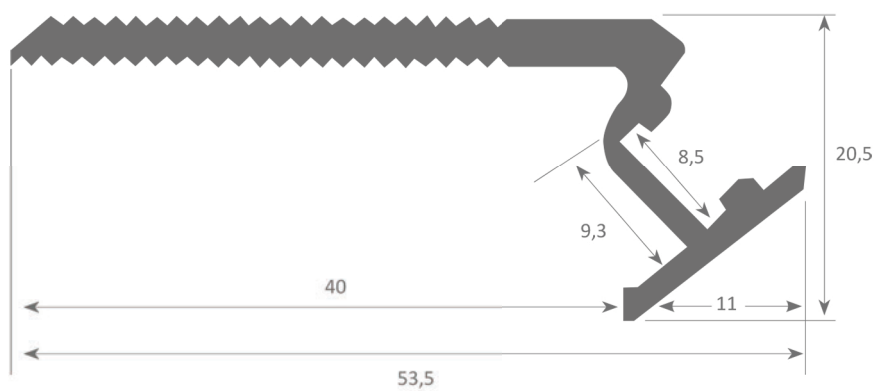



Profilé aluminium anodisé:
06.002 noir 2,40m



Diffuseur supérieur:
18.046 blanc 1m



Diffuseur inférieur:
18.047 blanc 2,40m



Diffuseur inférieur de couleur:
18.048 rouge 2,40m
18.049 bleu 2,40m
18.050 jaune 2,40m
18.051 rose 2,40m



Embout aluminium noir:
19.110 (set de 2 pièces)

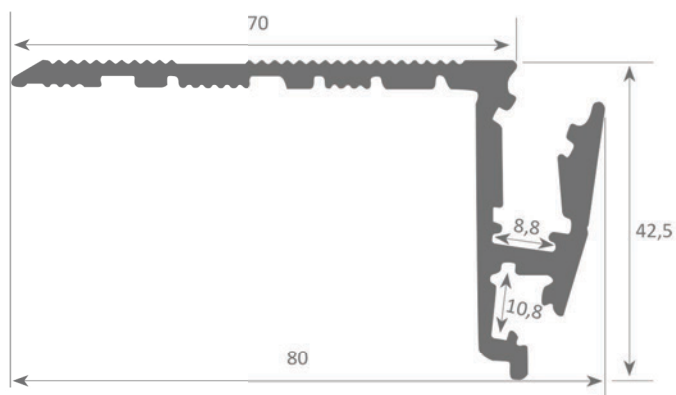
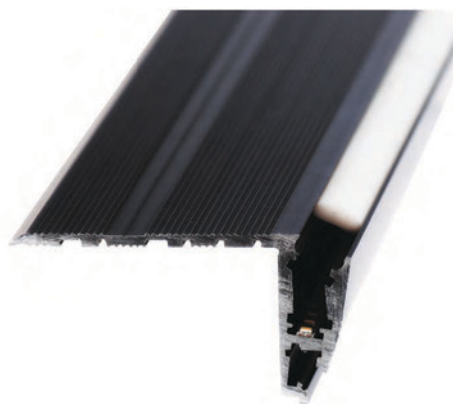



Profilé aluminium anodisé:
06.003 2m

IP 65



Diffuseur:
18.012 opale 2m



Embout plastique:
19.111 gris (set de 2 pièces)

Sur demande: - profilé noir
- longueur 3m



Platine interne:
22.017 aluminium 2m

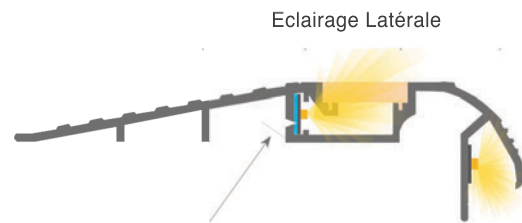
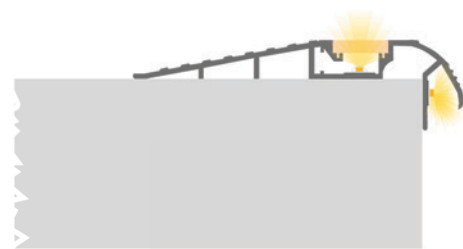

Prévoir l'accessoire 22.017

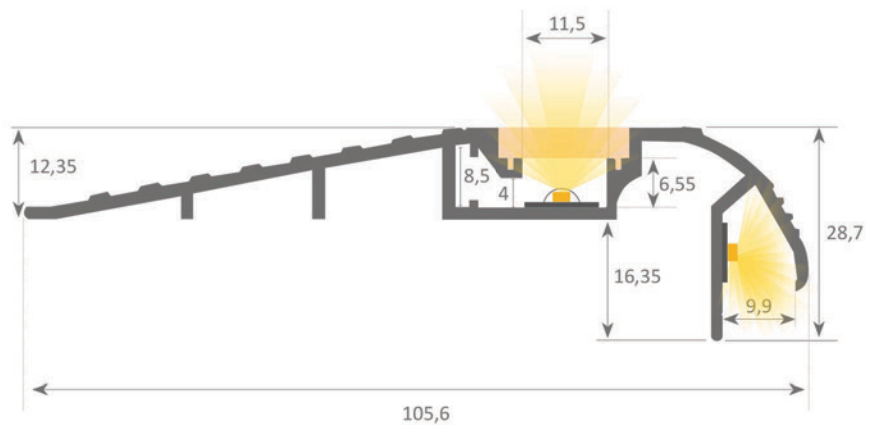





Profilé aluminium:
09.047 laqué blanc 2m



Diffuseur polycarbonate:
18.083 opale 2m



Embouts aluminium:
19.221 avec passage de câble
19.222 sans passage de câble



Clips inox:
20.052

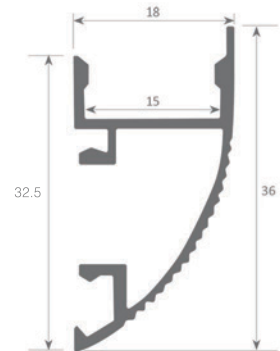



Profilé aluminium anodisé:
09.005 3m



Diffuseur polycarbonate:
18.063 opale 3m



Embout aluminium:
19.141 sans passage de câble



Clips inox:
20.024

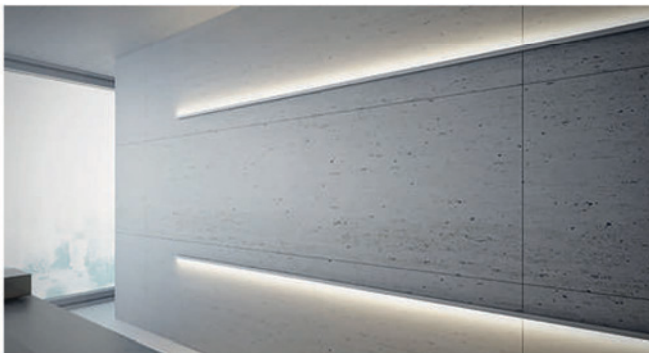
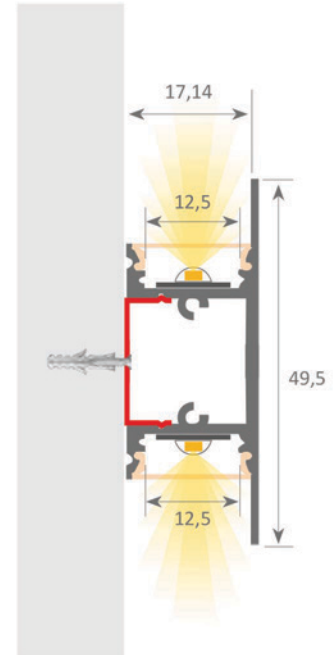



Profilé aluminium anodisé:
09.006 3m



Diffuseur polycarbonate:
18.064 opale 3m



Embout plastique:
19.142 sans passage de câble



Clips inox:
20.025

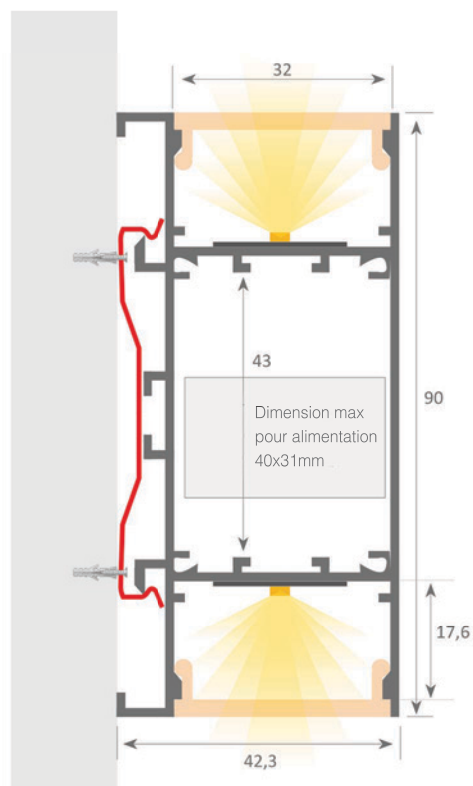



Profilé ABS plastique:
09.003 blanc 3m

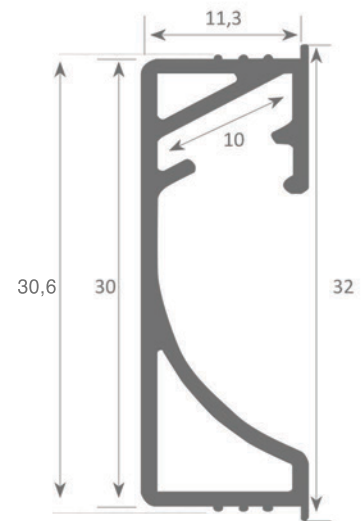
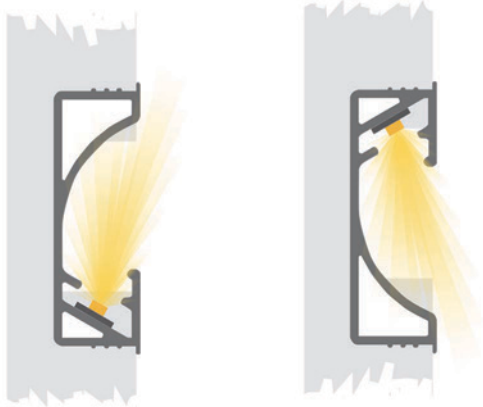
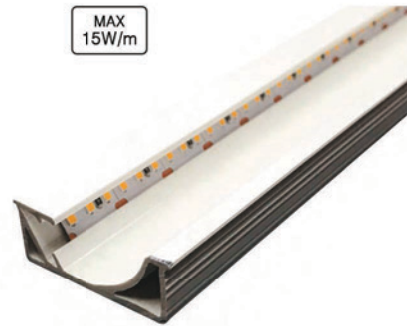



Profilé aluminium anodisé:
09.002 3m



Diffuseur polycarbonate:
18.062 opale 3m



Embout plastique:
19.138 gauche avec passage de câble
droite sans passage de câble
(set de 2 pièces)



MAX
20W/m

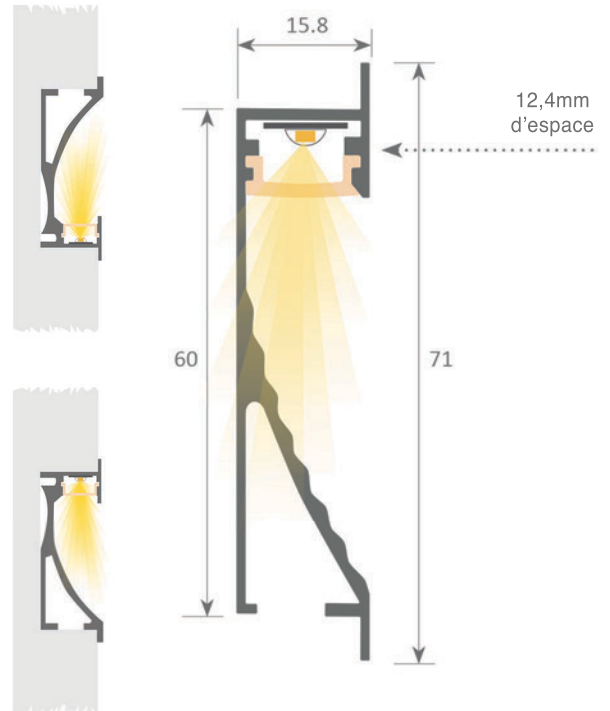



Profilé aluminium anodisé:
09.004 3m



Embout plastique:
19.139 sans passage de câble
19.140 avec passage de câble

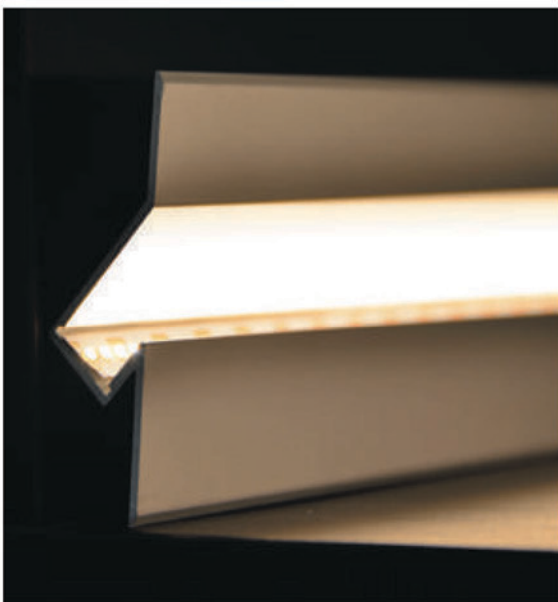
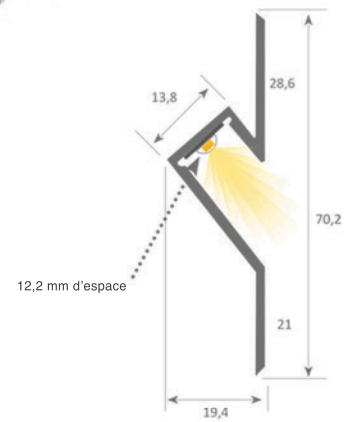
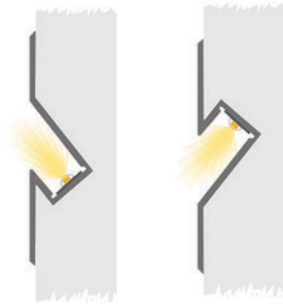
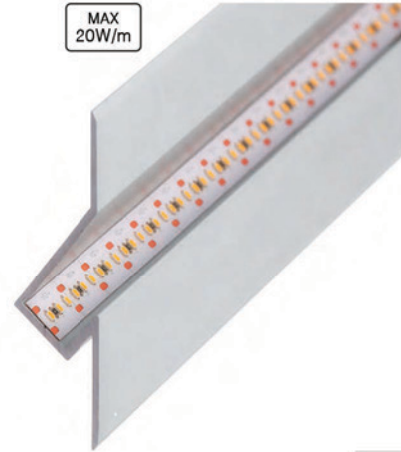





Demander notre documentation "ORAC"

"Led profilé Orac Decor" est une collection de différents profilés en polyuréthane haute densité et d'une excellente qualité, conçue pour décorer, offrant un éclairage indirect de faible consommation et de longue durée de vie grâce à la technologie LED. Une combinaison parfaite pour donner du caractère à votre projet avec une garantie totale de succès. Orac Decor se compose de deux collections distinctes:

Orac Decor Classic

Un ensemble de moulures classique.

Orac Decor Modern

Un ensemble de moulure rectiligne qui fournit un style plus moderne.

Série classic

Profilé aluminium
Alimentation

EXEMPLES DE COMBINAISONS

 <p>SHADE - C371L</p> <p>200 x 18,5 x 5,8 (cm)</p>	 <p>FLUXUS - C372L</p> <p>200 x 28 x 7 (cm)</p>	 <p>ANTONIO - C373L *C373FL</p> <p>200 x 8 x 5 (cm)</p> <p><small>Profilé en format flexible</small></p>	 <p>ANTONIO - C374L *C374FL</p> <p>200 x 18 x 5 (cm)</p> <p><small>Profilé en format flexible</small></p>
 <p>STRIPE - C361L</p> <p>200 x 5 x 5 (cm)</p>	 <p>CURVE - C362L</p> <p>200 x 5 x 5 (cm)</p>	 <p>MORITZ - C991L</p> <p>200 x 11 x 14 (cm)</p>	 <p>WAVE - C364L</p> <p>200 x 14 x 8 (cm)</p>
 <p>STRAIGHT - C357L</p> <p>200 x 7,1 x 11 (cm)</p>	 <p>RAIL - C358L</p> <p>200 x 7,3 x 14 (cm)</p>	 <p>FLAT - C352L</p> <p>200 x 7,6 x 17,1 (cm)</p>	 <p>BOAT - C351L</p> <p>200 x 7,4 x 17,3 (cm)</p>
 <p>LUXUS - C902L *C902FL</p> <p>200 x 10,3 x 10,3 (cm)</p>	 <p>LUXUS - C901L *C901FL</p> <p>200 x 14,8 x 12,4 (cm)</p> <p><small>Profilé en format flexible</small></p>	 <p>LUXUS - C900L</p> <p>200 x 17,1 x 14,6 (cm)</p>	

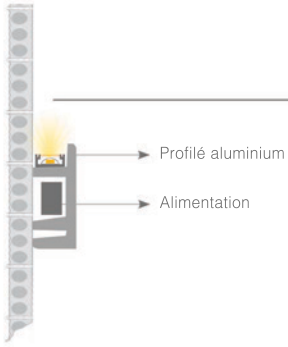

EXEMPLES DE COMBINAISONS



Série modern

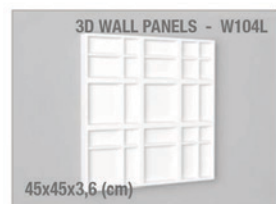
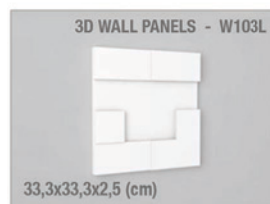
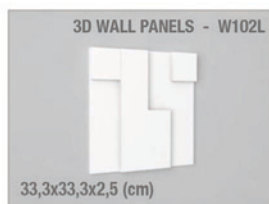
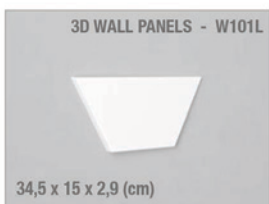
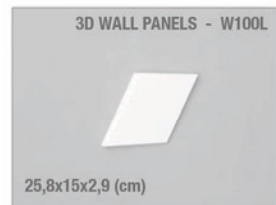
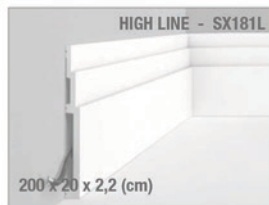
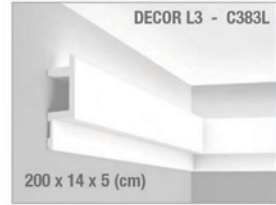
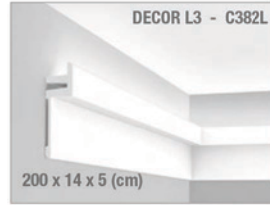
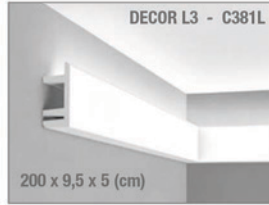

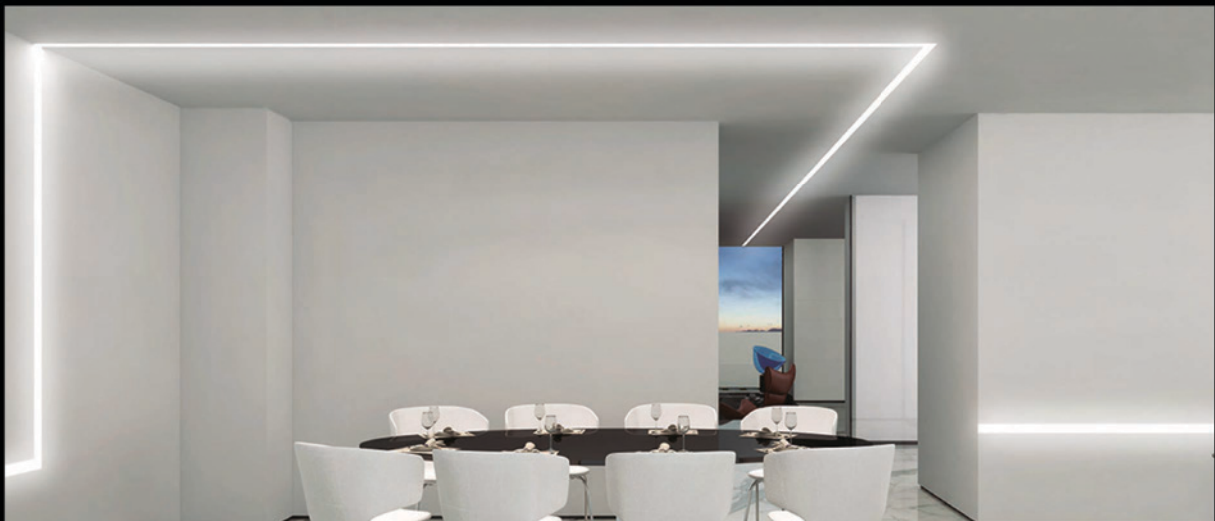



Profilé aluminium anodisé:
08.004 2m



Diffuseur polycarbonate:
18.056 opale 2m

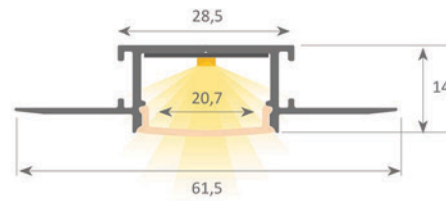

Embout plastique:
19.132 sans passage de câble
19.133 avec passage de câble

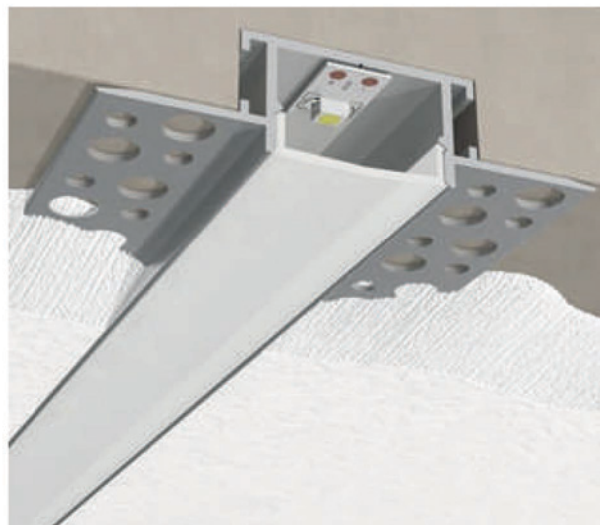
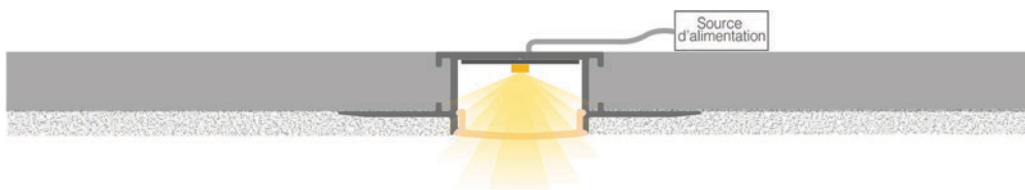



Profilé aluminium anodisé:
08.001 3m



Diffuseur polycarbonate:
18.018 opale 3m



Embout plastique:
19.126 sans passage de câble
19.127 avec passage de câble

MAX
20W/m

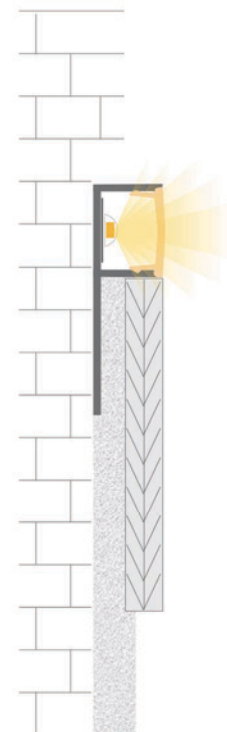
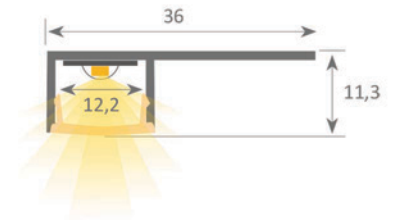



Profilé aluminium anodisé:
08.002 3m



Diffuseur polycarbonate:
18.018 opale 3m



Embout plastique:
19.128 sans passage de câble
19.129 avec passage de câble

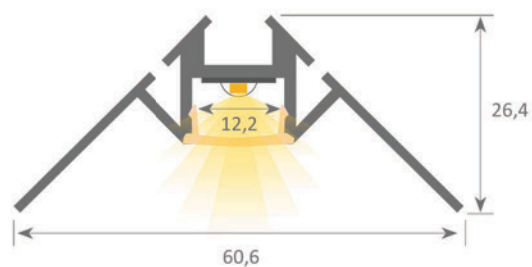



Profilé aluminium anodisé:
08.003 3m



Diffuseur polycarbonate:
18.018 opale 3m



Embout plastique:
19.130 sans passage de câble
19.131 avec passage de câble

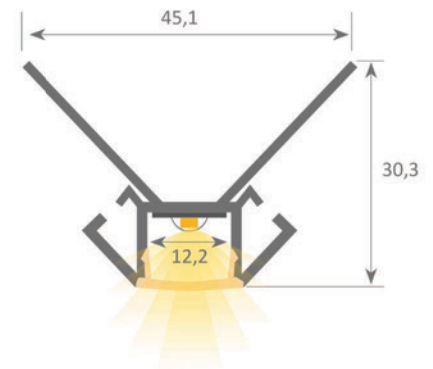
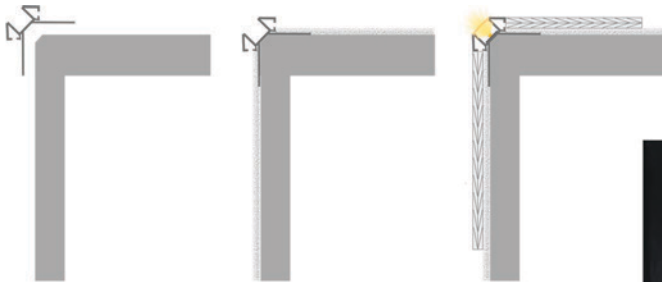





Profilé silicone :
10.005 opale 1-100m
Compatible LED largeur max 10mm

MAX
14W/m

IP 67



Embout silicone :
19.169 sans passage de câble
19.170 avec passage de câble
19.171 sans passage de câble frontal
19.172 avec passage de câble frontal



Clips aluminium:
20.036

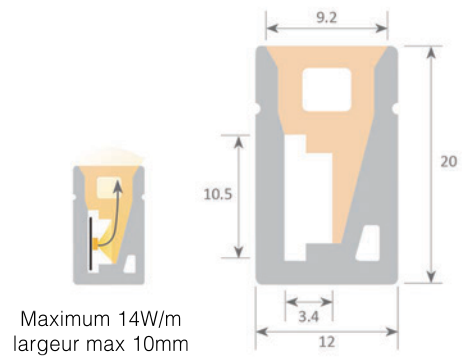

Silicone pour imperméabilisation:
22.033 100ml

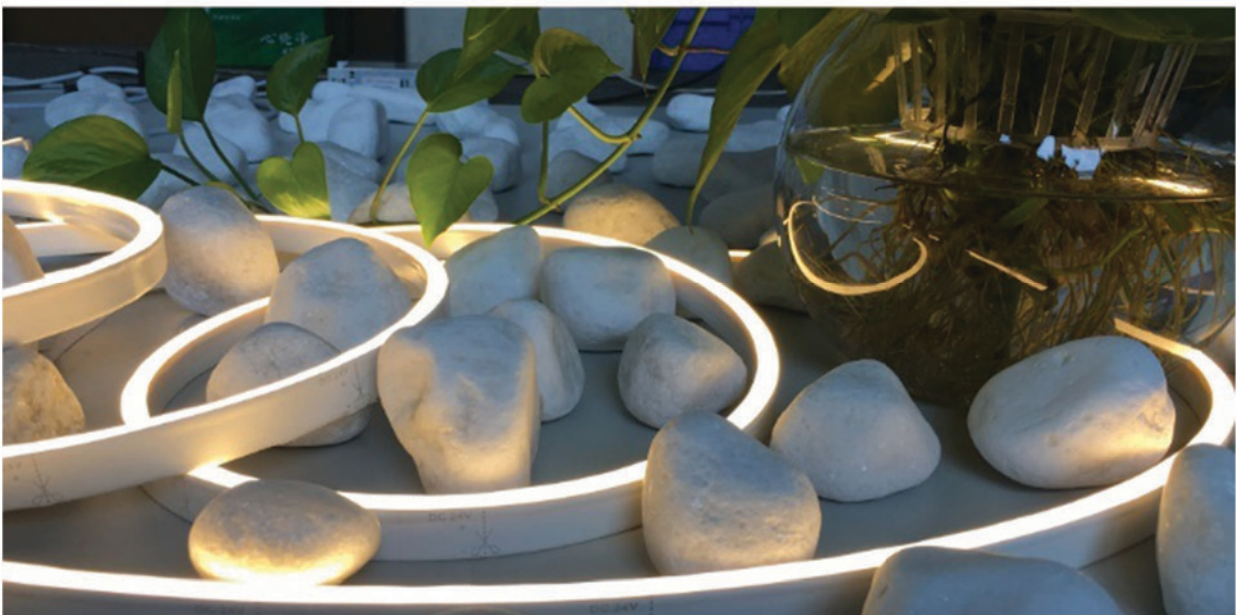

Néon Cuadrado



Profilé silicone:
10.003 oplae 1-100m
Compatible LED largeur max 6mm

MAX
12W/m

IP 67



Embout: silicone
19.164 sans passage de câble
19.165 avec passage de câble frontal
19.166 avec passage de câble latéral



Clips aluminium:
20.034



Maximum 12W/m
largeur max 6mm

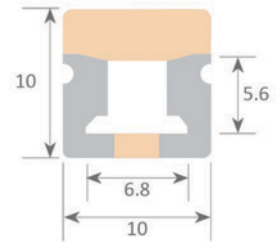

Silicone pour imperméabilisation:
22.033





Profilé aluminium anodisé:
11.001 anodisé 3m



Diffuseur polycarbonate:
18.065 opale 3m
18.066 transparent 3m



Embout plastique:
19.154 blanc avec passage de câble
19.155 blanc sans passage de câble



Clips acier:
20.027 chromé



Cintreuse:
22.031



22cm minimum

22cm minimum

MAX
20W/m

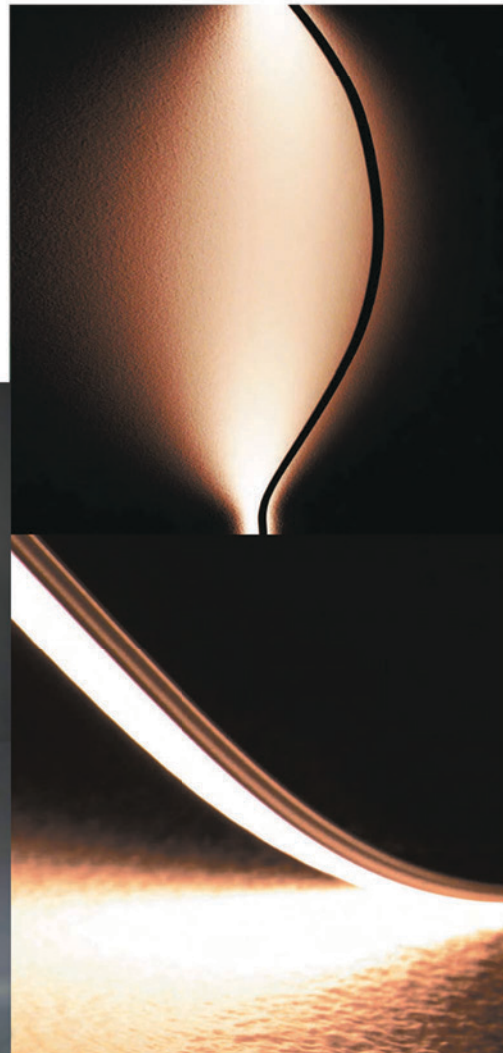
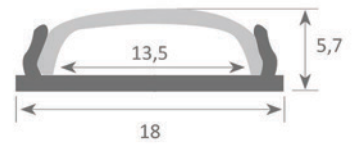

Diffuseurs PVC

Des profilés en plastique flexibles (step-fit), avec un traitement UV qui permettent d'être installé à l'extérieur. Il est recommandé de ne pas appliquer une led supérieure à 12W/m lorsqu'il n'y a pas une bonne dissipation de la chaleur. Ils sont également compatibles en tant que diffuseurs dans de nombreux profilés Led, ce qui permet l'utilisation de leds plus puissantes pour une diffusion parfaite de la lumière.

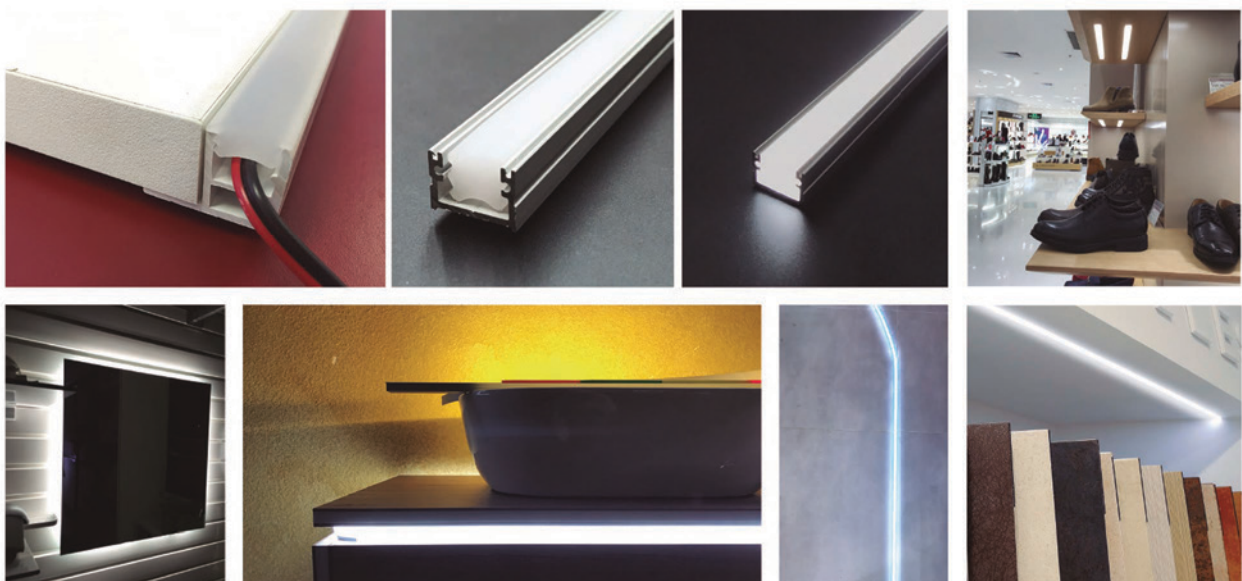
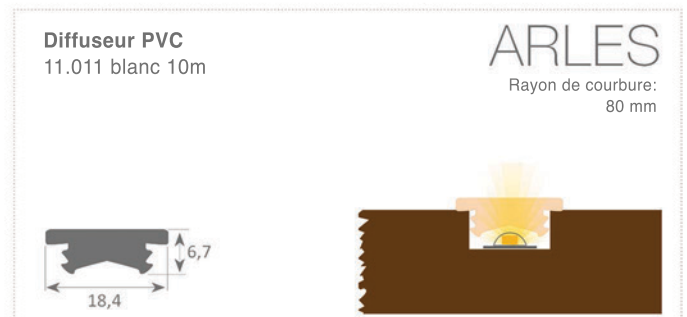
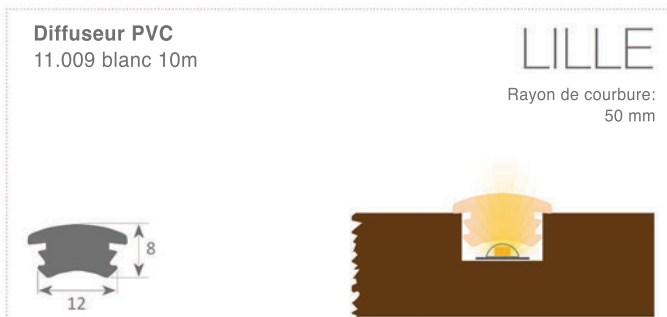
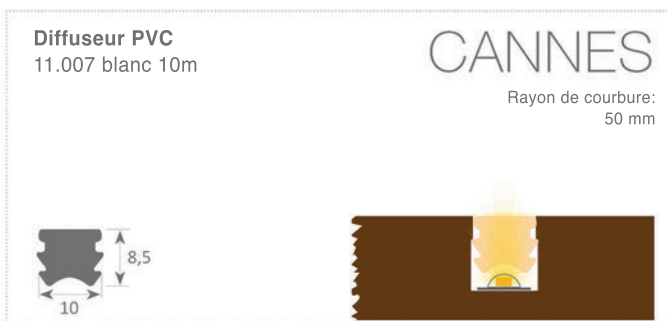
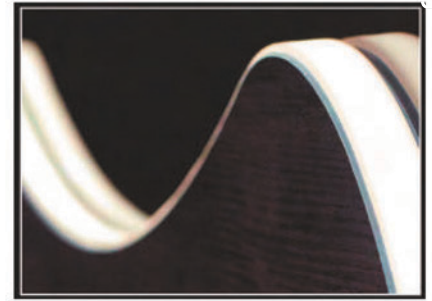

Structures

MOSCU
MAGNUM

MUNICH
MAGNUM

MOSCU
MAGNUM
SLIM

MUNICH
MAGNUM
SLIM

MOSCU
MINI

MUNICH
MINI



MOSCU
MINI

MOSCU
MAGNUM
SLIM

MOSCU
MAGNUM

MUNICH
MINI

MUNICH
MAGNUM
SLIM

MUNICH
MAGNUM



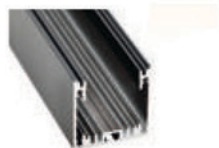

Profilé aluminium anodisé:

16.002 3m

Profilé aluminium noir:

16.003 3m

Profilé aluminium blanc:

16.004 3m



Diffuseur polycarbonate:

18.070 opale 3m

18.073 noir 3m

18.072 microprismatique 3m



Support angle verticale:

22.058 (set de 2 pièces)



Jonction linéaire:

22.034 (set de 2 pièces)



Support angle 90°:

22.035 (set de 2 pièces)



Support angle 120°:

22.004 (set de 2 pièces)



Extrémité aluminium:

19.228 aluminium

19.229 noir

19.230 blanc



Kit de suspension:

21.001 acier

21.003 noir

21.002 blanc

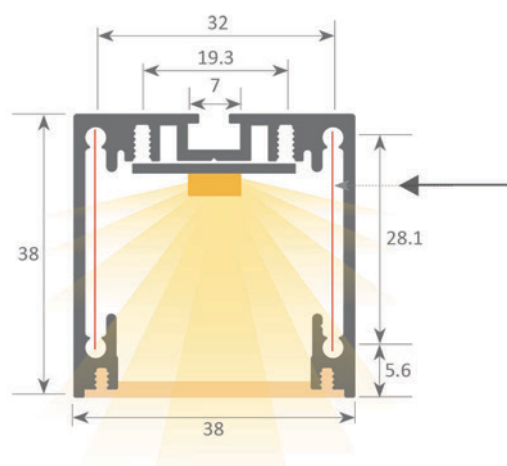

espace pour loger les plaques de jonction ou les supports intérieur à 90 °





Profilé aluminium anodisé:

17.001 3m

Profilé aluminium noir:

17.002 3m

Profilé aluminium blanc:

17.003 3m



Diffuseur polycarbonate:

18.070 opale 3m

18.073 noir 3m

18.072 microprismatique 3m



Diffuseur supérieur:

18.001 transparent 2m

18.002 opale 2m



Platine interne:

22.036 aluminium 2m



Extrémité aluminium:

19.231 aluminium

19.233 noir

19.232 blanc



Kit de suspension:

21.001 acier

21.003 noir

21.002 blanc

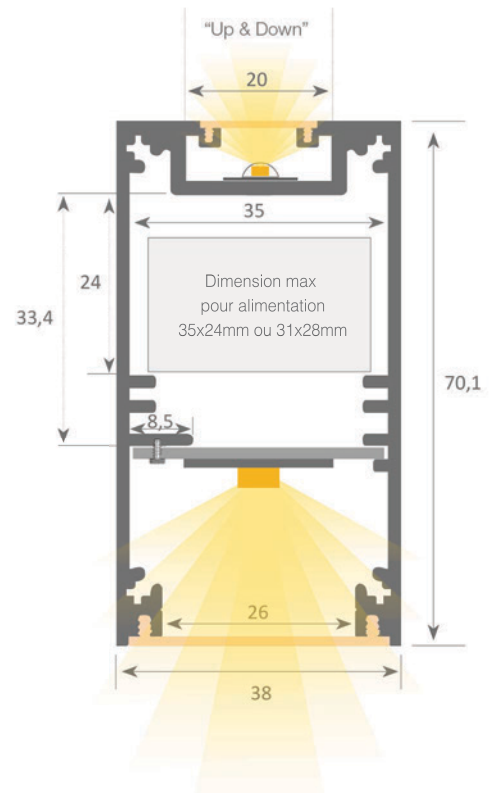



212



Profilé aluminium anodisé:

16.008 3m

Profilé aluminium noir:

16.010 3m

Profilé aluminium blanc:

16.009 3m



Réflecteur aluminium:

14.007 laqué blanc 3m



Diffuseur polycarbonate:

18.074 opale 3m

18.076 microprismatique 3m



Diffuseur supérieur:

18.015 opale 2m

18.014 transparent 2m



Support angle verticale:

22.046 (set de 2 pièces)



Jonction linéaire:

22.061 (set de 2 pièces)



Support angle 90°:

22.054 (set de 2 pièces)



Décharge de traction:

22.039 inox 18cm



Extrémité aluminium:

19.243 aluminium

19.245 noir

19.244 blanc



Kit de suspension:

21.001 acier

21.003 noir

21.002 blanc

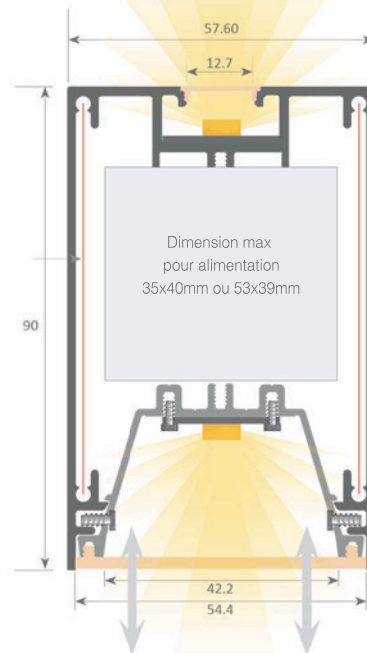



Profilé aluminium anodisé:

16.005 3m

Profilé aluminium noir:

16.006 3m

Profilé aluminium blanc:

16.007 3m



Diffuseur polycarbonate:

18.074 opale 3m

18.076 microprismatique 3m



Diffuseur supérieur:

18.002 opale 2m

18.001 transparent 2m



Platine interne:

22.042 aluminium 2m

22.051 pour led rigide 2m



Extrémité aluminium:

19.237 aluminium

19.238 noir

19.239 blanc



Kit de suspension:

21.001 acier

21.003 noir

21.002 blanc

IP 65

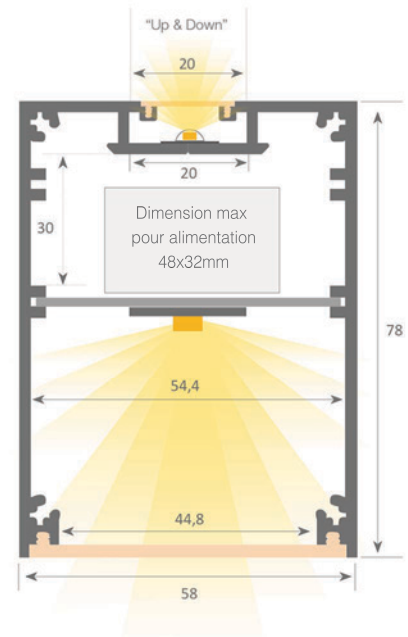

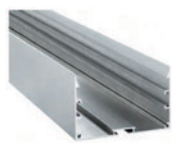

Profilé aluminium:
16.014 gris texturé 3,40m
16.015 blanc texturé 3,40m



Diffuseur polycarbonate:
18.080 3,40m



Extrémité aluminium:
19.249 aluminium
19.250 blanc



Platine interne:
22.045 aluminium 2m



Jonction linéaire:
22.044 acier (set de 2 pièces)



Support:
22.047 acier



Kit de suspension:
21.001 acier
21.002 blanc

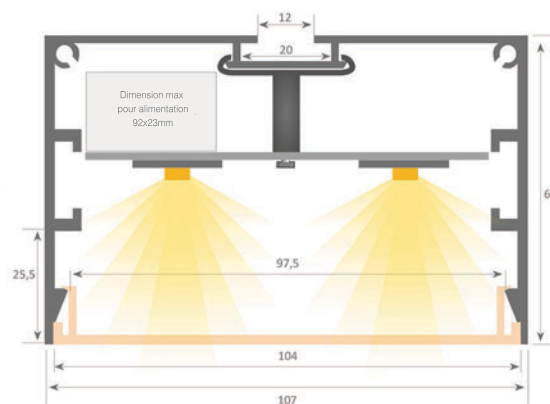
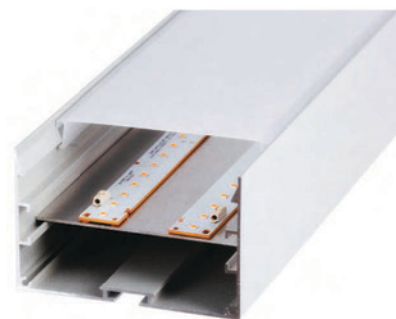

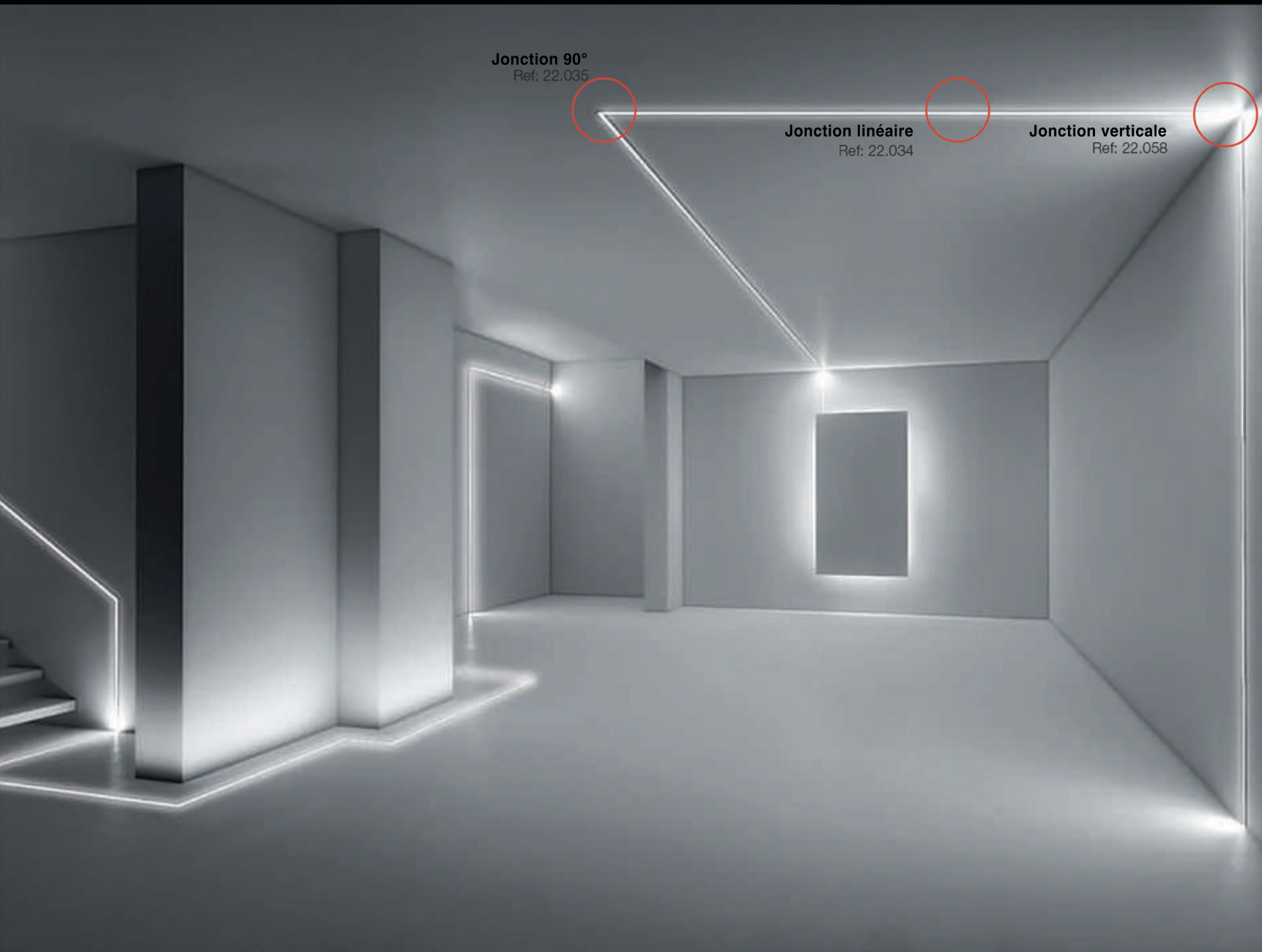

Jonction 90°
Ref: 22.035

Jonction linéaire
Ref: 22.034

Jonction verticale
Ref: 22.058

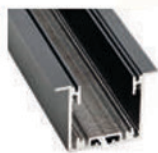

Profilé aluminium anodisé:

14.001 3m

Profilé aluminium noir:

14.003 3m

Profilé aluminium blanc:

14.002 3m



Diffuseur polycarbonate:

18.070 opale 3m

18.073 noir 3m

18.072 microprismatique 3m

IP 65



Support angle verticale:

22.058 (set de 2 pièces)



Jonction linéaire:

22.034 (set de 2 pièces)



Support angle 90°:

22.035 (set de 2 pièces)

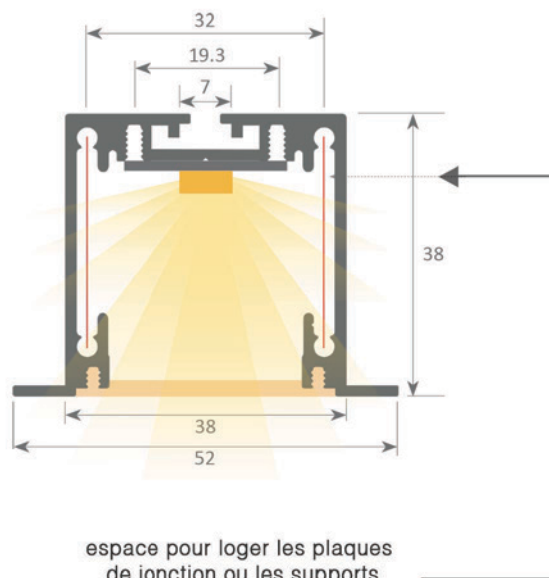

espace pour loger les plaques de jonction ou les supports intérieur à 90°



Embout aluminium:

19.186 aluminium

19.187 blanc

19.188 noir



Patte de fixation:

20.042



Pattes de fixation à ressort pour plafond métallique:

20.023

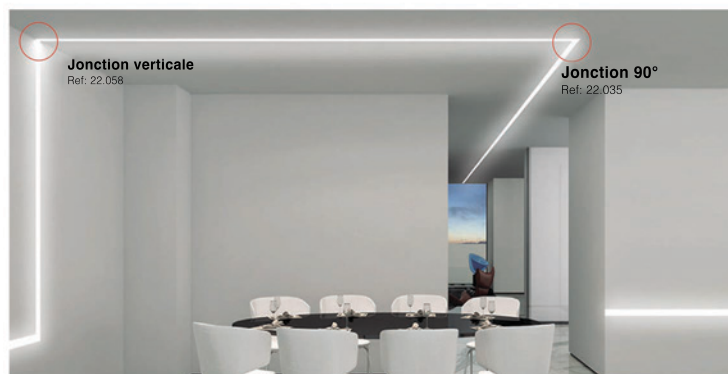



Profilé aluminium anodisé:

15.001 3m

Profilé aluminium noir:

15.003 3m

Profilé aluminium blanc:

15.002 3m



Diffuseur polycarbonate:

18.070 opale 3m

18.073 noir 3m

18.072 microprismatique 3m



Embout aluminium:

19.189 aluminium

19.190 blanc

19.191 noir



Platine interne:

22.036 aluminium 2m



Patte de fixation:

22.043 acier

IP 65

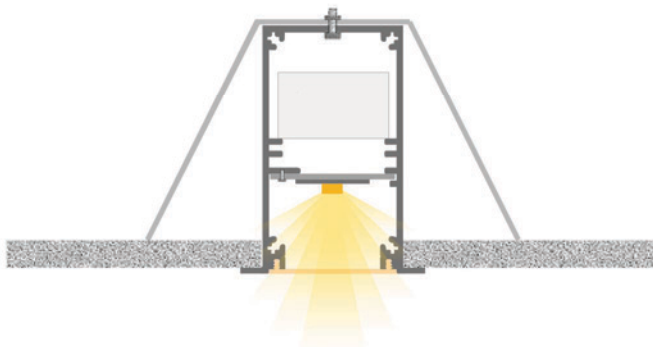
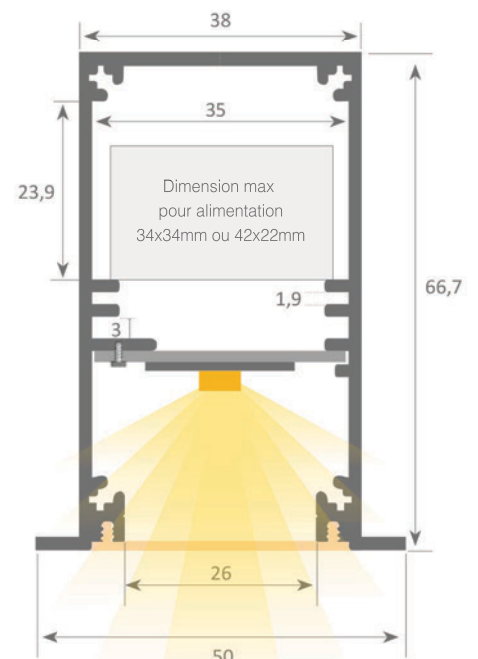



Profilé aluminium anodisé:

14.011 3,40m

Profilé aluminium noir:

14.013 3,40m

Profilé aluminium blanc:

14.012 3,40m



Profilé aluminium interne:

14.024 aluminium 1,124m

14.022 blanc 1,124m

14.023 noir 1,124m



Diffuseur polycarbonate:

18.079 opale 3,40m



Embout aluminium:

19.201 aluminium

19.202 blanc

19.203 noir



Jonction linéaire:

22.044 acier (set de 2 pièces)



Décharge de traction:

22.039 inox 18cm



Patte de fixation:

20.047acier

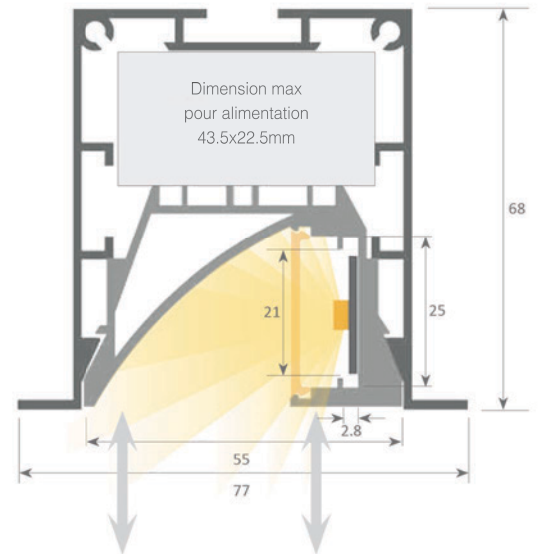

Système avec plateau amovible avant qui permet un accès facile à la bande led et à l'alimentation électrique, permettant ainsi une maintenance rapide et simple de l'installation électrique.





Profilé aluminium anodisé:

14.004 3m

Profilé aluminium noir:

14.005 3m

Profilé aluminium blanc:

14.006 3m



Réflecteur aluminium:

14.007 laqué blanc 3m



Diffuseur polycarbonate:

18.074 opale 3m

18.076 microprismatique 3m



Support angle verticale:

22.059 (set de 2 pièces)



Jonction linéaire:

22.038 (set de 2 pièces)



Support angle 90°:

22.037 (set de 2 pièces)



Décharge de traction:

22.039 inox 18cm



Extrémité aluminium:

19.192 aluminium

19.194 noir

19.193 blanc



Patte de fixation:

21.044 acier

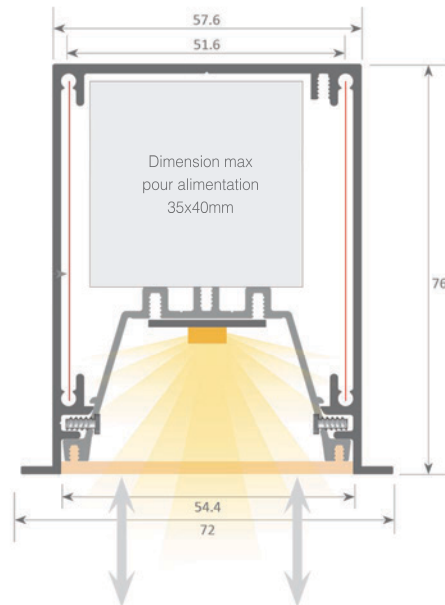

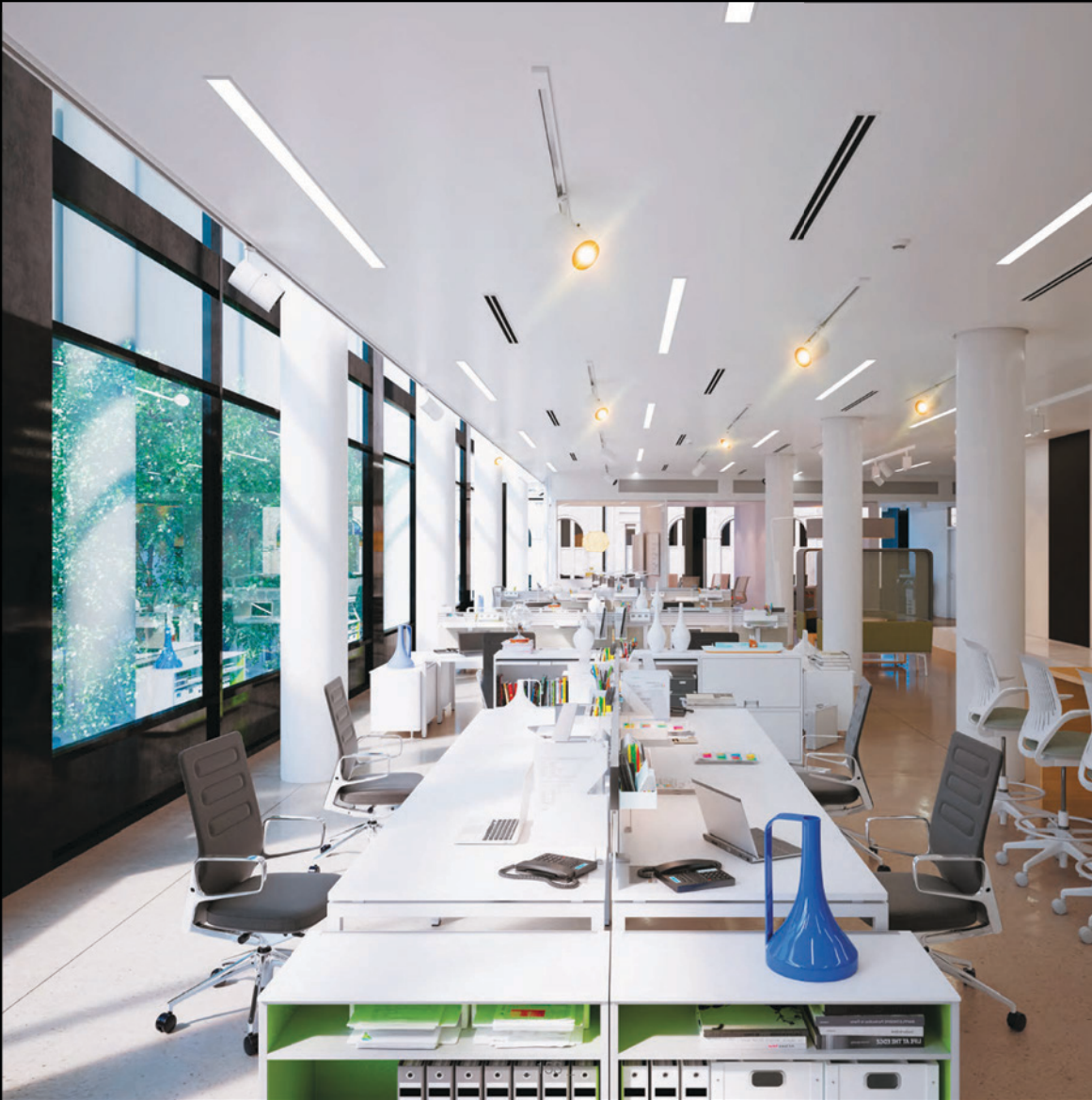



Profilé aluminium anodisé:

14.008 3m

Profilé aluminium noir:

14.010 3m

Profilé aluminium blanc:

14.009 3m



Diffuseur polycarbonate:

18.074 opale 3m

18.076 microprismatique 3m

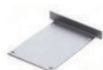

Extrémité aluminium:

19.198 gris

19.200 noir

19.199 blanc



Patte de fixation:

20.046 acier



Platine interne:

22.042 aluminium 2m

IP 65

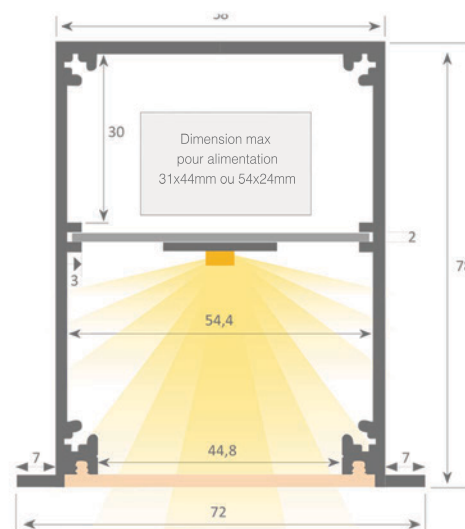

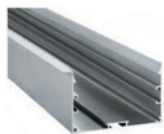

Profilé aluminium:

14.020 3,40m

Profilé aluminium blanc:

14.021 3,40m



Diffuseur polycarbonate:

18.080 opale 3,40m



Platine interne:

22.045 aluminium 2m



Extrémité aluminium:

19.204 aluminium

19.205 blanc



Jonction linéaire:

22.044 acier (set de 2 pièces)



Patte de fixation:

22.048 acier



Entretoise:

22.047

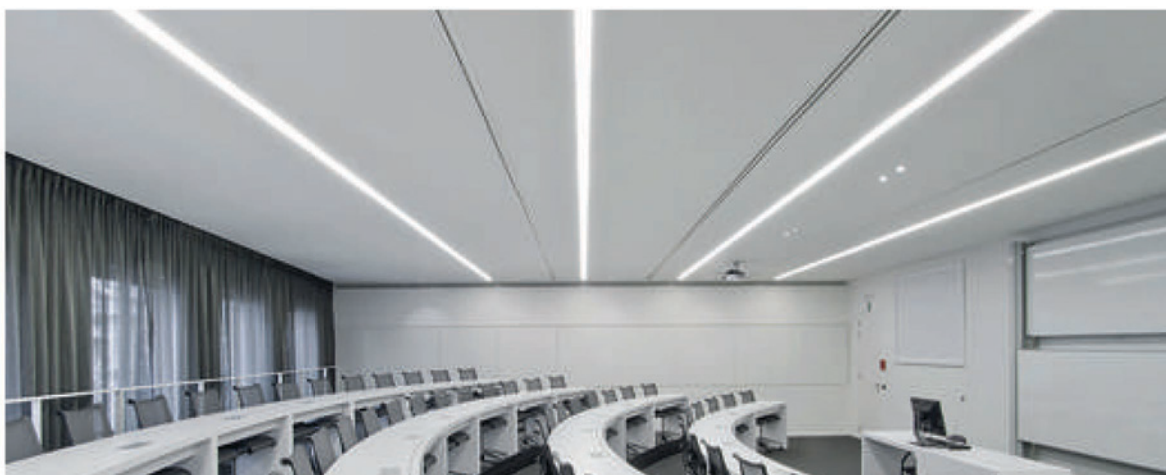
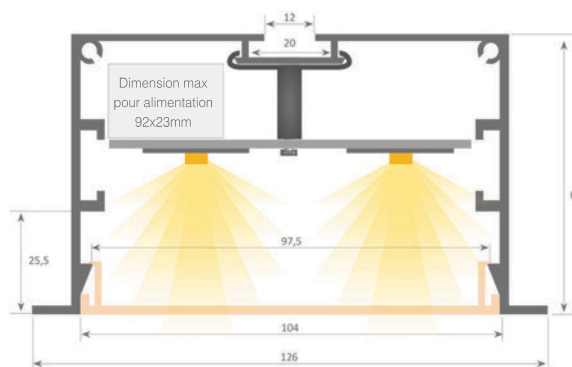
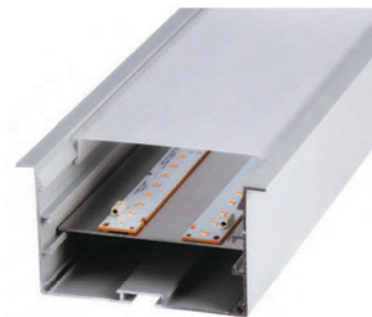





Luminaire fabriqué avec profil d'aluminium laqué en blanc texturé ou noir texturé, puis éclairé avec bande LED en 3000°K ou 4000°K. Il permet d'être fixé en surface, ou suspendu grâce au kit de suspension et petite rosace inclus. La rosace référence 46.015 se fournit sur demande.

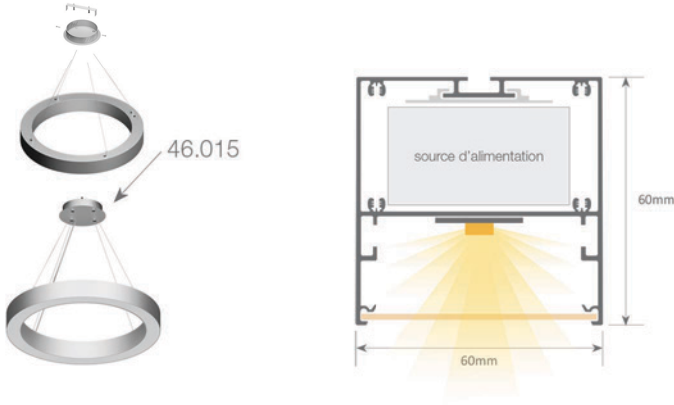

SATURNE 60

80.001 3000°K laqué blanc texturé
 80.002 4000°K laqué blanc texturé
 80.004 3000°K laqué noir texturé
 80.005 4000°K laqué noir texturé

Rosace blanche:
 46.015



Puissance (W)	20W
Alimentation	230V
Lumens (4000°K)	2800Lm
Diffusion	120°
Eclairage	direct
Protection	IP20
Diamètre	660mm
Section	60x60mm
Alimentation on-off	inclus
Kit de suspension	inclus



SATURNE 90

80.007 3000°K laqué blanc texturé
 80.008 4000°K laqué blanc texturé
 80.010 3000°K laqué noir texturé
 80.011 4000°K laqué noir texturé

Rosace blanche:
 46.015



Puissance (W)	40W
Alimentation	230V
Lumens (4000°K)	3600Lm
Diffusion	120°
Eclairage	direct
Protection	IP20
Diamètre	900mm
Section	60x60mm
Alimentation on-off	inclus
Kit de suspension	inclus



SATURNE 120

80.013 3000°K laqué blanc texturé
 80.014 4000°K laqué blanc texturé
 80.016 3000°K laqué noir texturé
 80.017 4000°K laqué noir texturé

Rosace blanche:
 46.015



Puissance (W)	50W
Alimentation	230V
Lumens (4000°K)	4500Lm
Diffusion	120°
Eclairage	direct
Protection	IP20
Diamètre	1200mm
Section	60x60mm
Alimentation on-off	inclus
Kit de suspension	inclus



Profilé polycarbonate:
13.019 opale 3m



Platine interne:
22.014 aluminium 2m



Extrémité méthacrylate:
19.099



Clips polycarbonate transparent:
20.020 transparent
20.021 inox



Suspension:
21.001 (clips non inclus)



Embout décoratif:
19.100 bleu
19.101 blanc
19.102 noir
19.103 rouge

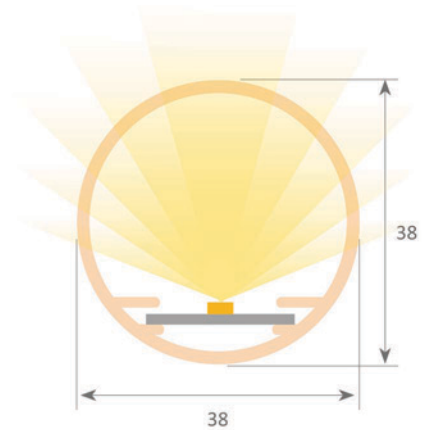



Profilé polycarbonate:
13.020 noir 3m



Platine interne:
22.014 aluminium



Extrémité méthacrylate:
19.104



Clips polycarbonate:
20.020 transparent
20.021 inox



Kit de suspension: (Clips non inclus)
21.001 gris
21.002 blanc
21.003 noir



Embouts décoratif:
19.100 bleu
19.101 blanc
19.102 noir
19.103 rouge

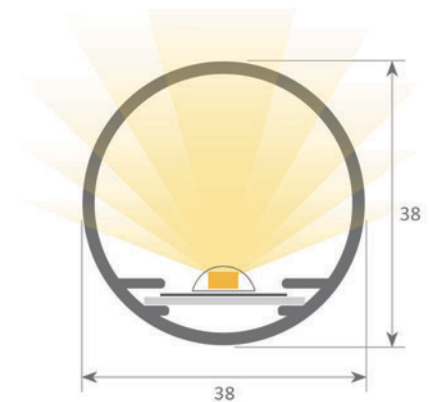



Profilé aluminium anodisé:
13.022 3m



Diffuseur polycarbonate:
18.069 opale 3m



Embout plastique:
19.107 sans passage de câble



Suspension:
21.001

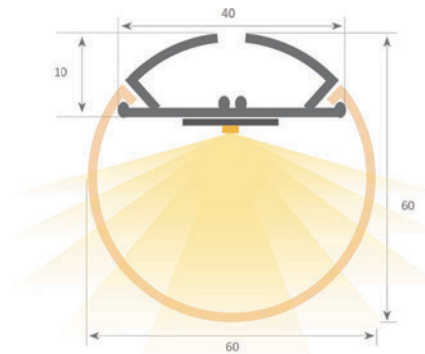



Profilé aluminium anodisé:
16.001 2m



Embout plastique ventilé:
19.212

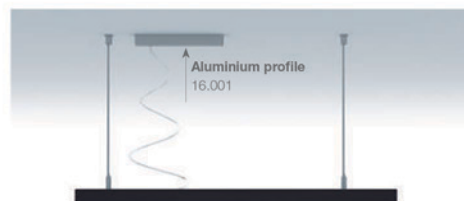
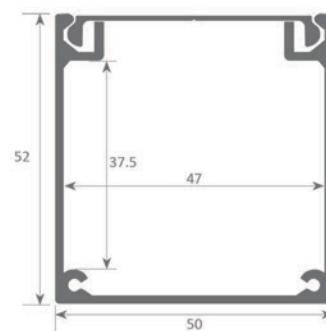

Led souple



Led souple



LED flexibles

- Dimmable 24V
- Flux lumineux de haut rendement: 600, 1200, 1800, 3200 LM
- Durée de vie 50'000 heures
- Rendu des couleurs: IRC 85 à 95
- Indice de protection IP 20, 65, 68
- Tonalité des blancs: 2800°K à 6000°K

TRIDONIC EPISTAR

Tonalités des blancs



Blanc chaud



Blanc neutre



Blanc froid

Led souple

4.8W/m

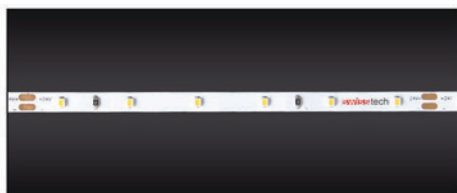

Ref.: LED4827KIP20 - 2700°K
 Ref.: LED4830KIP20 - 3000°K
 Ref.: LED4840KIP20 - 4000°K

Puissance	4,8W/m
Tension	24VDC
Lumens 2700°K	380 Lm/m Ra>90
Lumens 3000°K	400 Lm/m Ra>90
Lumens 4000°K	420 Lm/m Ra>90
Emission	120°
Indice de protection	IP20
N° leds/m	60
Dimensions	5.000x5x3mm
Section de découpe	50mm
PCB	5mm
Température de fonctionnement	-20°C / +40°C
Conditionnement	1 rouleau/5m
Durée de vie moyenne	50'000 heures

9.6W/m

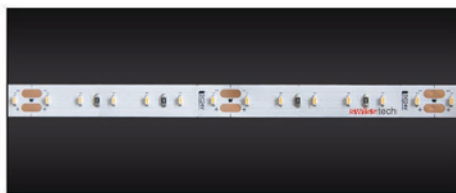

Ref.: LED9627KIP20 - 2700°K
 Ref.: LED9630KIP20 - 3000°K
 Ref.: LED9640KIP20 - 4000°K

Puissance	9,6W/m
Tension	24VDC
Lumens 2700°K	880 Lm/m Ra>95
Lumens 3000°K	920 Lm/m Ra>95
Lumens 4000°K	960 Lm/m Ra>95
Emission	120°
Indice de protection	IP20
N° leds/m	120
Dimensions	5.000x8x3mm
Section de découpe	50mm
PCB	8mm
Température de fonctionnement	-20°C / +40°C
Conditionnement	1 rouleau/5m
Durée de vie moyenne	50'000 heures

9.6W/m IP65

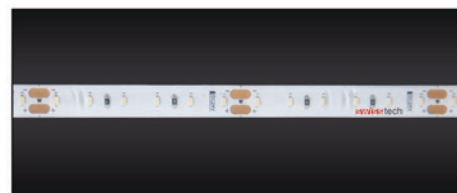

Ref.: LED9627KIP65 - 2700°K
 Ref.: LED9630KIP65 - 3000°K
 Ref.: LED9640KIP65 - 4000°K

Puissance	9,6W/m
Tension	24VDC
Lumens 2700°K	880 Lm/m Ra>95
Lumens 3000°K	920 Lm/m Ra>95
Lumens 4000°K	960 Lm/m Ra>95
Emission	120°
Indice de protection	IP65
N° leds/m	120
Dimensions	5.000x8x3mm
Section de découpe	50mm
PCB	8mm
Température de fonctionnement	-20°C / +40°C
Conditionnement	1 rouleau/5m
Durée de vie moyenne	50'000 heures

14.4W/m

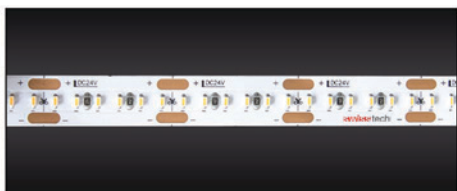

Ref.: LED1427KIP20 - 2700°K
 Ref.: LED1430KIP20 - 3000°K
 Ref.: LED1440KIP20 - 4000°K

Puissance	14,4W/m
Tension	24VDC
Lumens 2700°K	1340 Lm/m Ra>95
Lumens 3000°K	1390 Lm/m Ra>95
Lumens 4000°K	1440 Lm/m Ra>95
Emission	120°
Indice de protection	IP20
N° leds/m	240
Dimensions	5.000x10x3mm
Section de découpe	25mm
PCB	10mm
Température de fonctionnement	-20°C / +40°C
Conditionnement	1 rouleau/5m
Durée de vie moyenne	50'000 heures

14.4W/m IP65



Ref.: LED1427KIP65 - 2700°K
 Ref.: LED1430KIP65 - 3000°K
 Ref.: LED1440KIP65 - 4000°K

Puissance	14,4W/m
Tension	24VDC
Lumens 2700°K	1340 Lm/m Ra>95
Lumens 3000°K	1390 Lm/m Ra>95
Lumens 4000°K	1440 Lm/m Ra>95
Emission	120°
Indice de protection	IP65
N° leds/m	240
Dimensions	5.000x10x3mm
Section de découpe	25mm
PCB	10mm
Température de fonctionnement	-20°C / +40°C
Conditionnement	1 rouleau/5m
Durée de vie moyenne	50'000 heures

15W/m



Ref.: LED1527KIP20 - 2700°K
 Ref.: LED1530KIP20 - 3000°K
 Ref.: LED1540KIP20 - 4000°K

Puissance	15W/m
Tension	24VDC
Lumens 2700°K	1470 Lm/m Ra>90
Lumens 3000°K	1490 Lm/m Ra>90
Lumens 4000°K	1510 Lm/m Ra>90
Emission	120°
Indice de protection	IP20
N° leds/m	480
Dimensions	5.000x10x3mm
Section de découpe	50mm
PCB	10mm
Température de fonctionnement	-20°C / +40°C
Conditionnement	1 rouleau/5m
Durée de vie moyenne	50'000 heures

Led souple

19.2W/m



Ref.: LED1927KIP20 - 2700°K
 Ref.: LED1930KIP20 - 3000°K
 Ref.: LED1940KIP20 - 4000°K

Puissance	19,2W/m
Tension	24VDC
Lumens 2700°K	1820 Lm/m Ra>95
Lumens 3000°K	1880 Lm/m Ra>95
Lumens 4000°K	1920 Lm/m Ra>95
Emission	120°
Indice de protection	IP20
N° leds/m	240
Dimensions	5.000x10x3mm
Section de découpe	25mm
PCB	10mm
Température de fonctionnement	-20°C / +40°C
Conditionnement	1 rouleau/5m
Durée de vie moyenne	50'000 heures

19.2W/m IP65

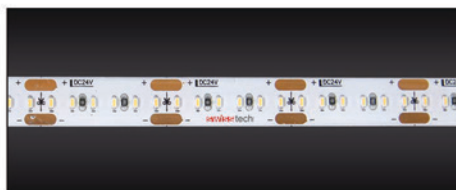

Ref.: LED1927KIP65 - 2700°K
 Ref.: LED1930KIP65 - 3000°K
 Ref.: LED1940KIP65 - 4000°K

Puissance	19,2W/m
Tension	24VDC
Lumens 2700°K	1820 Lm/m Ra>95
Lumens 3000°K	1880 Lm/m Ra>95
Lumens 4000°K	1920 Lm/m Ra>95
Emission	120°
Indice de protection	IP65
N° leds/m	240
Dimensions	5.000x10x3mm
Section de découpe	25mm
PCB	10mm
Température de fonctionnement	-20°C / +40°C
Conditionnement	1 rouleau/5m
Durée de vie moyenne	50'000 heures

22W/m



Ref.: LED2227KIP20 - 2700°K
 Ref.: LED2230KIP20 - 3000°K
 Ref.: LED2240KIP20 - 4000°K

Puissance	22W/m
Tension	24VDC
Lumens 2700°K	2950 Lm/m Ra>90
Lumens 3000°K	3180 Lm/m Ra>90
Lumens 4000°K	3300 Lm/m Ra>90
Emission	120°
Indice de protection	IP20
N° leds/m	128
Dimensions	5.000x12x3mm
Section de découpe	63mm
PCB	12mm
Température de fonctionnement	-20°C / +40°C
Conditionnement	1 rouleau/5m
Durée de vie moyenne	50'000 heures

RGBW



Ref.: LED19RGBWWIP20 - 3000°K
 Ref.: LED19RGBCWIP20 - 4000°K

Puissance	19,2/m
Tension	24VDC
Lumens	850 Lm/m Ra>80
Emission	120°
Indice de protection	IP20
N° leds/m	60
Dimensions	5.000x10x3mm
Section de découpe	50mm
PCB	10mm
Température de fonctionnement	-20°C / +40°C
Conditionnement	1 rouleau/5m
Durée de vie moyenne	50'000 heures

RGBW IP65



Ref.: LED19RGBWWIP65 - 3000°K
 Ref.: LED19RGBCWIP65 - 4000°K

Puissance	19,2/m
Tension	24VDC
Lumens	850 Lm/m Ra>80
Emission	120°
Indice de protection	IP65
N° leds/m	60
Dimensions	5.000x10x3mm
Section de découpe	50mm
PCB	10mm
Température de fonctionnement	-20°C / +40°C
Conditionnement	1 rouleau/5m
Durée de vie moyenne	50'000 heures

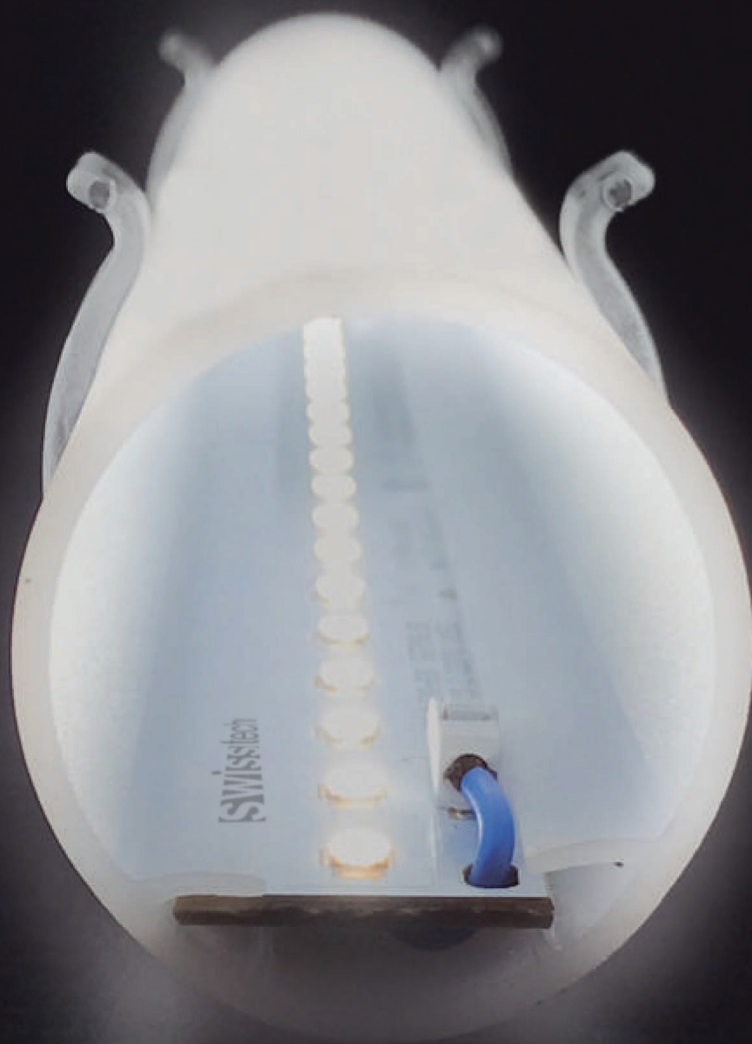

Led rigide

140x20mm



Ref.: 36.007 - 3000°K - Courant constant
Ref.: 36.008 - 4000°K - Courant constant

280x20mm

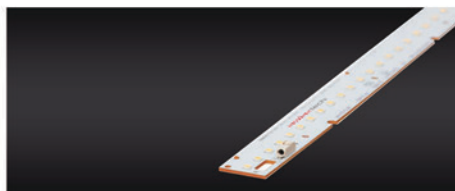

Ref.: 36.010 - 3000°K - Courant constant
Ref.: 36.011 - 4000°K - Courant constant

560x20mm

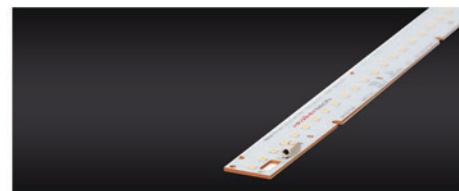

Ref.: 36.013 - 3000°K - Courant constant
Ref.: 36.014 - 4000°K - Courant constant

Puissance	4W / 5,9W / 8,5W
Courant	350mA / 500mA / 700mA
Lumens 3000°K	680Lm / 950Lm / 1295Lm
Lumens 4000°K	730Lm / 1025Lm / 1395Lm
CRI	>85
Emission	120°
Indice de protection	IP20
N° leds/ module	12
Dimensions	140x20x1.6mm
Section de découpe	non
Température de fonctionnement	-20°C / +75°C
Conditionnement	1 Pièce
Durée de vie moyenne	50'000 heures
Compatible	1-10V / DALI

Puissance	7,9W / 11,7W / 16,9W
Courant	350mA / 500mA / 700mA
Lumens 3000°K	1360Lm / 1900Lm / 2590Lm
Lumens 4000°K	1460Lm / 2050Lm / 2790Lm
CRI	>85
Emission	120°
Indice de protection	IP20
N° leds/ module	24
Dimensions	280x20x1.6mm
Section de découpe	non
Température de fonctionnement	-20°C / +75°C
Conditionnement	1 Pièce
Durée de vie moyenne	50'000 heures
Compatible	1-10V / DALI

Puissance	15,8W / 23,4W / 33,9W
Courant	350mA / 500mA / 700mA
Lumens 3000°K	2720Lm / 3800Lm / 5180Lm
Lumens 4000°K	2920Lm / 4100Lm / 5580Lm
CRI	>85
Emission	120°
Indice de protection	IP20
N° leds/ module	48
Dimensions	560x20x1.6mm
Section de découpe	non
Température de fonctionnement	-20°C / +75°C
Conditionnement	1 Pièce
Durée de vie moyenne	50'000 heures
Compatible	1-10V / DALI

Alimentation IP20 pour LED rigide "Courant constant"



			350mA	500mA	700mA	
38.013	No	6-14W	✓	✗	✗	230x30x21
38.014	No	12-21W	✗	✓	✓	230x30x21
38.017	1-10V	12-80W	✗	✓	✓	425x30x21
Alimentations avec 2 canaux chacun de 40W						
38.012	No	20-40W	✓	✓	✓	360x30x21
38.015	DALI/PUSH	21-42W	✓	✓	✓	358x30x21
38.011	No	42-80W	✓	✓	✓	360x30x21
38.016	DALI/PUSH	42-84W	✓	✓	✓	358x30x21
38.019	No	70-120W	✗	✓	✓	280x30x21
38.020	No	95-165W	✗	✓	✓	359x30x21

Capteur tactile "flush"
(avec voyant lumineux)

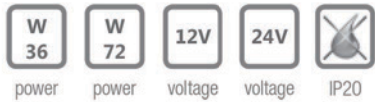

Réf.: 41.011
12V-24V



Capteur tactile intégré avec fonction On-Off. L'intensité de la lumière peut être réglée. Fonctionnement à 12V - 24V. Produit recommandé uniquement pour usage intérieur. Un seul capteur peut être appliqué dans une seule installation.

Puissance (W)	24W (12V)
Puissance (W)	48W (24V)
Sortie	1
Intensité	2A
Dimensions	Ø 22mm
Dimable	oui
Température	-20°C / + 45°C
Poids	65g
Protection	IP20
Garantie	2 ans

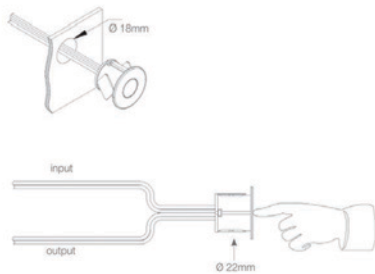

Capteur "mouvement"
(sans voyant lumineux)

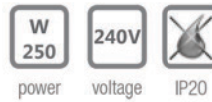

Réf.: 41.013
100V-240V



Capteur de mouvement à un angle de 120°. A placer dans les espaces où il y a "passage de personnes" (escaliers, couloirs...). Fonctionnement en 230V. Driver inclus. Produit recommandé uniquement pour usage intérieur. Un seul capteur peut être raccordé dans une installation.

Puissance (W)	250W
Entrée	100V - 240V
Sortie	100V - 240V
Angle de détection	120°
Dimensions	76x35x19.5mm
Dimensions	Ø 18mm
Température	-20°C / + 45°C
Diamètre	15mm
Protection	IP20
Garantie	2 ans

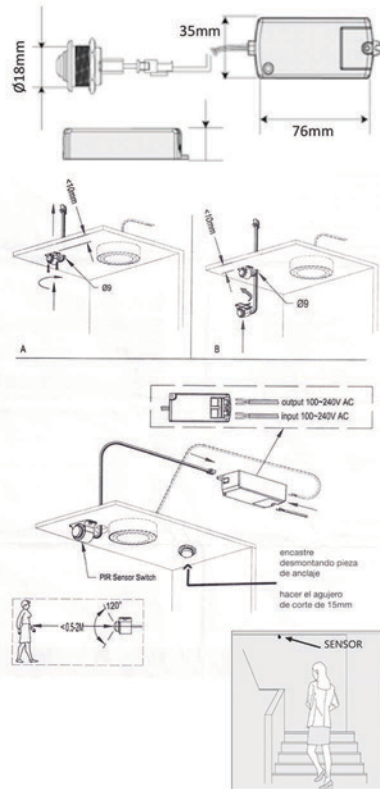

Capteur Bluetouch (avec voyant lumineux)

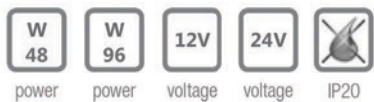

Réf.: 41.005 (avec voyant lumineux)
12V-24V



Interrupteur avec une fonction de variation tactile pour le montage sur les profils LED. Le diffuseur est placé sur le module (ne nécessite pas d'usinage).

Une fois éteint, la lampe témoin de couleur bleue reste allumée. Permet l'activation / désactivation et intensité de la led (0% à 100%). Il est recommandé de placer une couche isolante dans le bas du capteur lors du montage dans le profil led pour éviter tout dysfonctionnement.

Produit recommandé uniquement pour usage intérieur. Un seul capteur peut être appliqué à un luminaire.

Puissance (W)	48W (12V)
Puissance (W)	96W (24V)
Sortie	1
Intensité	4A
Dimensions	60x11x5mm
Régulateur	0% - 100%
LED indicateur	couleur bleue
On-Off	Tactile
Protection	IP20
Garantie	2 ans

Capteur de présence

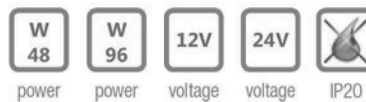

Réf.: 41.006
12V-24V



Capteur de présence de petit format pour montage sur les profils. Actif lorsque le mouvement est détecté à distance à environ 2,5 mètres du capteur et à un angle de 90°. Tout en se déplaçant le capteur continuera d'agir. Une fois qu'il arrête de détecter le mouvement le capteur reste allumé pour 45 secondes et sera désactivé. Il est recommandé de placer une couche isolante dans le bas du capteur lors du montage dans le profil led pour éviter tout dysfonctionnement.

Produit recommandé uniquement pour usage intérieur.

Puissance (W)	48W (12V)
Puissance (W)	96W (24V)
Sortie	1
Intensité	4A
Dimensions	48x11x11 mm
Angle de détection	90°
Distance détection	2,5m
Poids	4,8g
Protection	IP20
Garantie	2 ans

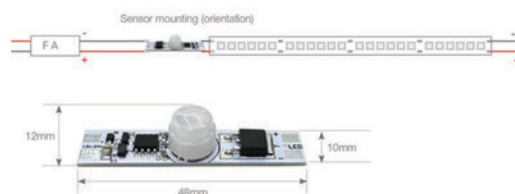
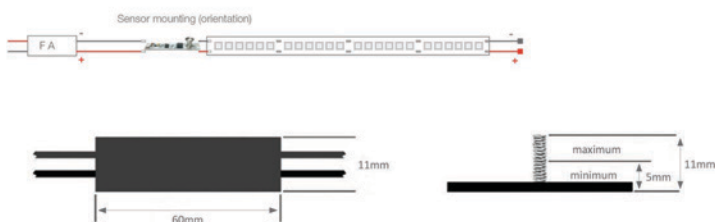

Platine de commande (face avant)



15 mètres 2,4GH

Platine de commande (face arrière)



230V

IP20 Wifi

Récepteur "RN8" (avec voyant lumineux)



power power voltage voltage IP20

Réf.: 41.026
12V-24V



Puissance (W)	180W (12V)
Puissance (W)	360W (24V)
Canaux	5
Détection (distance)	15m
Dimensions	124x38x23mm
Dimable	oui
Température	-20°C / + 65°C
Protection	IP20

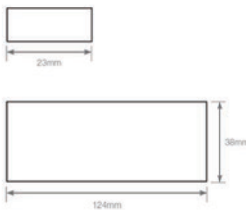

Réf.: 41.031 - Platine de commande

Une platine de commande petite mais élégante pour les surfaces murales avec une façade en verre trempé. Elle est capable de contrôler 4 zones différentes. Elle dispose d'un écran tactile d'une capacité de 2,4 GHz et est utilisée pour contrôler les installations à LED RGBW.

Elle est fixée au mur avec des vis et un espace suffisant doit être envisagé dans la surface à encaster. La platine doit être connectée à 230V. La platine donne des instructions au récepteur (41.032) par radiofréquence. Récepteur non inclus.

Ecran tactile	oui
Alimentation	230V
RGBW (variation)	oui
Blanc (variation)	oui
Vitesse régulation + / -	oui
Mémoire	oui
Distance détection	15 mètres
Dimensions	86x86x33mm
Panneau avant	verre trempé
Protection	IP20

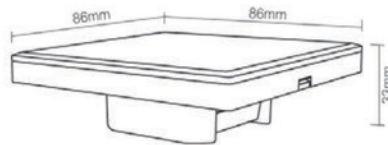

Platine de commande (face avant)



15 mètres 2,4GH

Platine de commande (face arrière)



3V (2 x AAA batteries)



Récepteur "RN8" (avec voyant lumineux)

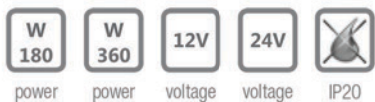

Réf.: 41.026
12V-24V



Puissance (W)	180W (12V)
Puissance (W)	360W (24V)
Canaux	5
Détection (distance)	15m
Dimensions	124x38x23mm
Dimable	oui
Température	-20°C / + 65°C
Protection	IP20



Réf.: 41.030 - Platine de commande
Réf.: 42.045 - Batterie AAA (2 pièces)

Une platine de commande petite mais élégante pour les surfaces murales avec une façade en verre trempé. Elle est capable de contrôler 4 zones différentes. Elle dispose d'un écran tactile d'une capacité de 2,4 GHz et est utilisée pour contrôler les installations à LED RGBW.

Elle est fixée au mur en utilisant du ruban adhésif double face ou peut être vissée. 2 piles sont nécessaires (AAA). Elle donne des instructions au récepteur (41.026) par radiofréquence. Récepteur non inclus.

Ecran tactile	oui
Alimentation	2 batteries 3V AAA
RGBW (variation)	oui
Blanc (variation)	oui
Vitesse régulation + / -	oui
Mémoire	oui
Distance détection	15 mètres
Dimensions	86x86x20mm
Panneau avant	verre trempé
Protection	IP20

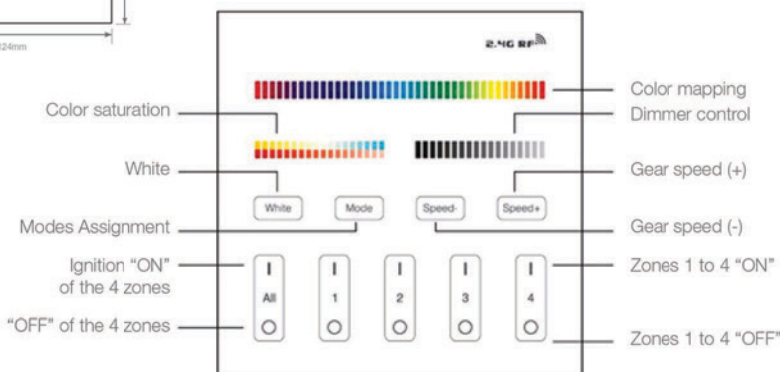
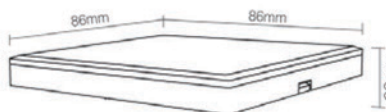

Télécommande RGBW + Séquenceur

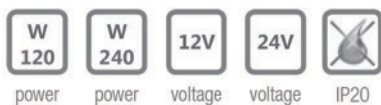

Réf.: 41.049
12V-24V



Séquenceur RGBW avec une sortie maximale de 10A. Pas de mémoire. Comprend une télécommande avec un récepteur de signal. Batterie non incluse. La charge maximale que nous pouvons utiliser est de 2,5A si nous utilisons les 4 canaux (RGBW), car la sortie maximale est de 10A. Si la consommation de l'installation est supérieure alors il faut utiliser des amplificateurs. Effectuez des changements séquentiels et progressifs avec scintillement (flash) ainsi que d'autres changements de couleur prédéfinis. • Il permet la régulation de l'intensité et le contrôle de la couleur du changement de vitesse.

Recommandé: à combiner dans l'installation si nous dépassons 5 mètres de bande LED avec l'amplificateur 41.022.

Puissance	120W (12V)
Puissance	240W (24V)
Canaux	4
Intensité	2,5A x 4canaux
Distance détection	15 mètres
Séquenceur	inclus
Protection	IP20

Amplificateur

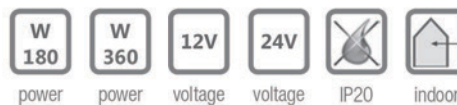

Réf.: 41.022
12V-24V



Amplificateur RGBW non étanche avec une puissance maximale de 15A. Il doit être alimenté par l'alimentation (canal d'entrée: +/-). Nous pouvons installer autant d'amplificateurs que nécessaire, en les connectant les uns aux autres et à leurs alimentations correspondantes. Ce produit est destiné à une utilisation en intérieur.

Puissance	180W (12V)
Puissance	360W (24V)
Canaux	4
Intensité	3,75A x 4canaux
Dimensions	119x47x23mm
Protection	IP20

Schéma d'installation:

Pour les grandes installations, nous devons installer des amplificateurs réf: 41.022, de cette façon nous éviterons les pertes de lumière. Les alimentations doivent toujours être supérieures à la consommation que nous avons, laissant une marge de sécurité (15-20% recommandé).

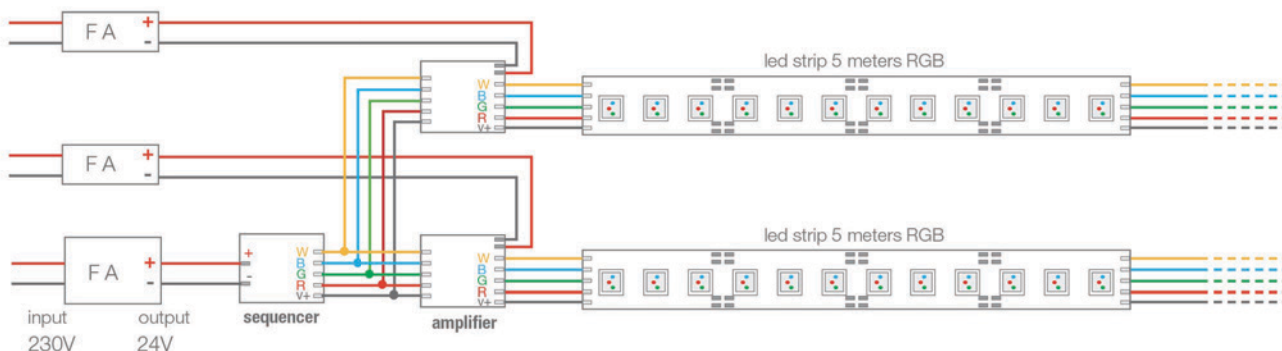

Alimentations

Alimentation IP67 à tension constante 24V.
Durée de vie 50'000 heures.



Référence	Tension	Puissance	Intensité	Facteur de puissance	Indice de protection	Poids	Dimensions
CE18/24M	24V	18W	0,75A	>0,5	IP67	220gr.	118x35x26
CE60/24M	24V	60W	2,5A	>0,5	IP67	400gr.	163x43x32
CE100/24M	24V	100W	4,2A	>0,5	IP67	630gr.	190x52x39
CE150/24M	24V	150W	6,3A	>0,5	IP67	1.150gr.	228x68x39

Alimentations à tension constante 24V.
Durée de vie 50'000 heures.



Référence	Tension	Puissance	Intensité	Facteur de puissance	Indice de protection	Poids	Dimensions
CN30/24M	24V	30W	1,25A	>0,9	IP20	125gr.	153x41x32
CN75/24M	24V	75W	3,12A	>0,9	IP20	370gr.	180x52x30
CN120/24M	24V	120W	5A	>0,9	IP20	425gr.	300x40x30
CN180/24M	24V	180W	7,5A	>0,9	IP20	665gr.	345x50x35
CN320/24M	24V	320W	13A	>0,5	IP20	1100gr.	215x115x30
CN30/24SLIM	24V	30W	1,25A	>0,95	IP20	146gr.	245x30x14
CN60/24SLIM	24V	60W	2,5A	>0,98	IP20	170gr.	290x45x18

Alimentations à tension constante 24V variable.
Durée de vie 50'000 heures. 1-10v / Push Button



Référence	Tension	Puissance	Variation	Facteur de puissance	Indice de protection	Poids	Dimensions
HE3075-A	24V	75W	10-100%	0.97	IP20	210gr.	150x54x31

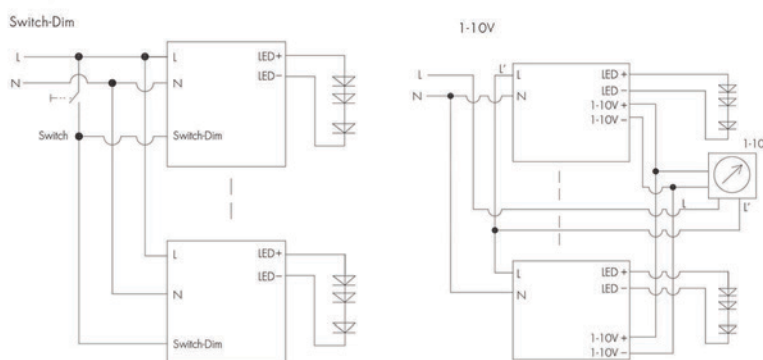

Alimentations à tension constante 24V variable.
Durée de vie 50'000 heures. DALI / Push Button / Corridor fonction



Référence	Tension	Puissance	Variation	Facteur de puissance	Indice de protection	Poids	Dimensions
LCA35W24V	24V	35W	1-100%	0.95	IP20	157gr.	195x43x30
LCA60W24V	24V	60W	1-100%	0.95	IP20	180gr.	225x43x30
LCA100W24V	24V	100W	1-100%	0.95	IP20	254gr.	295x43x30
LCA150W24V	24V	150W	1-100%	0.95	IP20	298gr.	325x43x30

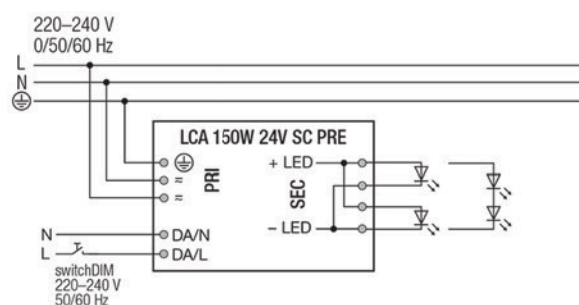
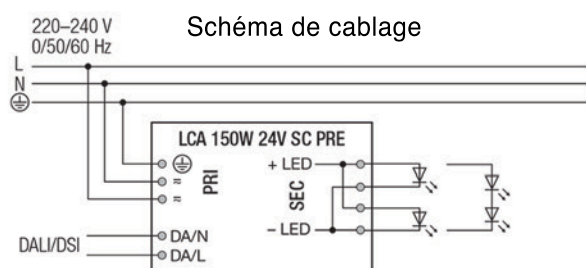

Ces documentations font partie de notre large gamme de produits d'éclairage, que vous découvrirez sur notre site:
www.swisstech.pro

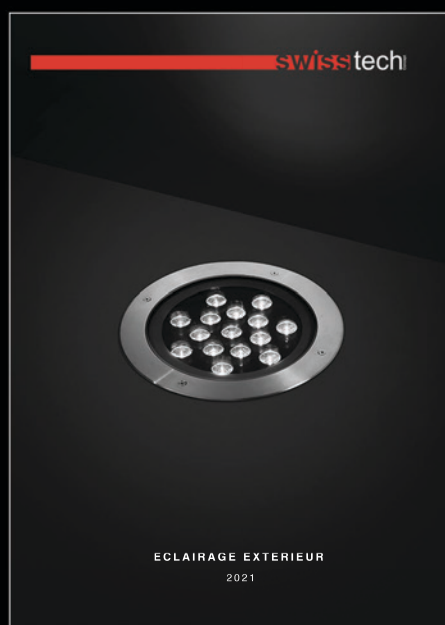

Nous sommes à votre entière disposition, pour répondre à vos questions

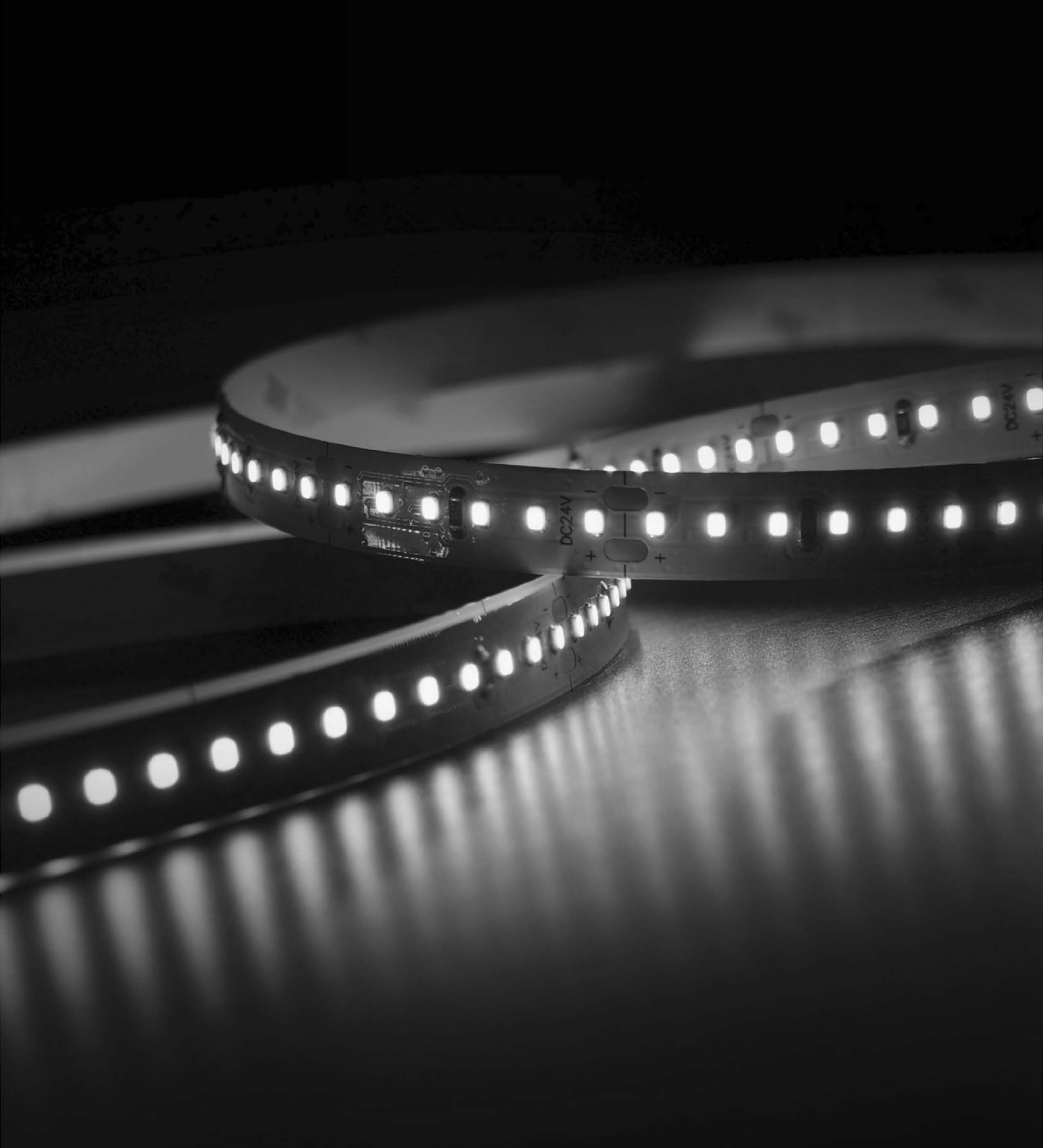

Swisstech Concept Sàrl

Route des Jeunes 4A, 1227 Les Acacias
+41 22 792 03 25 - www.swisstech.pro