

ARCHITECTURAL



2024

F A R O
BARCELONA

swisstech Concept

Distributeur officiel de la gamme

32-81

TRACKLIGHT

82-237

DOWNLICO

238-309

SURFACE

310-333

SUSPENDED

334-405

SYSTEMS

406-421

LED STRIPES & PROFILES

422 - 427

CONNECTIVITY (Dali / Casambi)

428-431

Drivers

TS GHTS ED

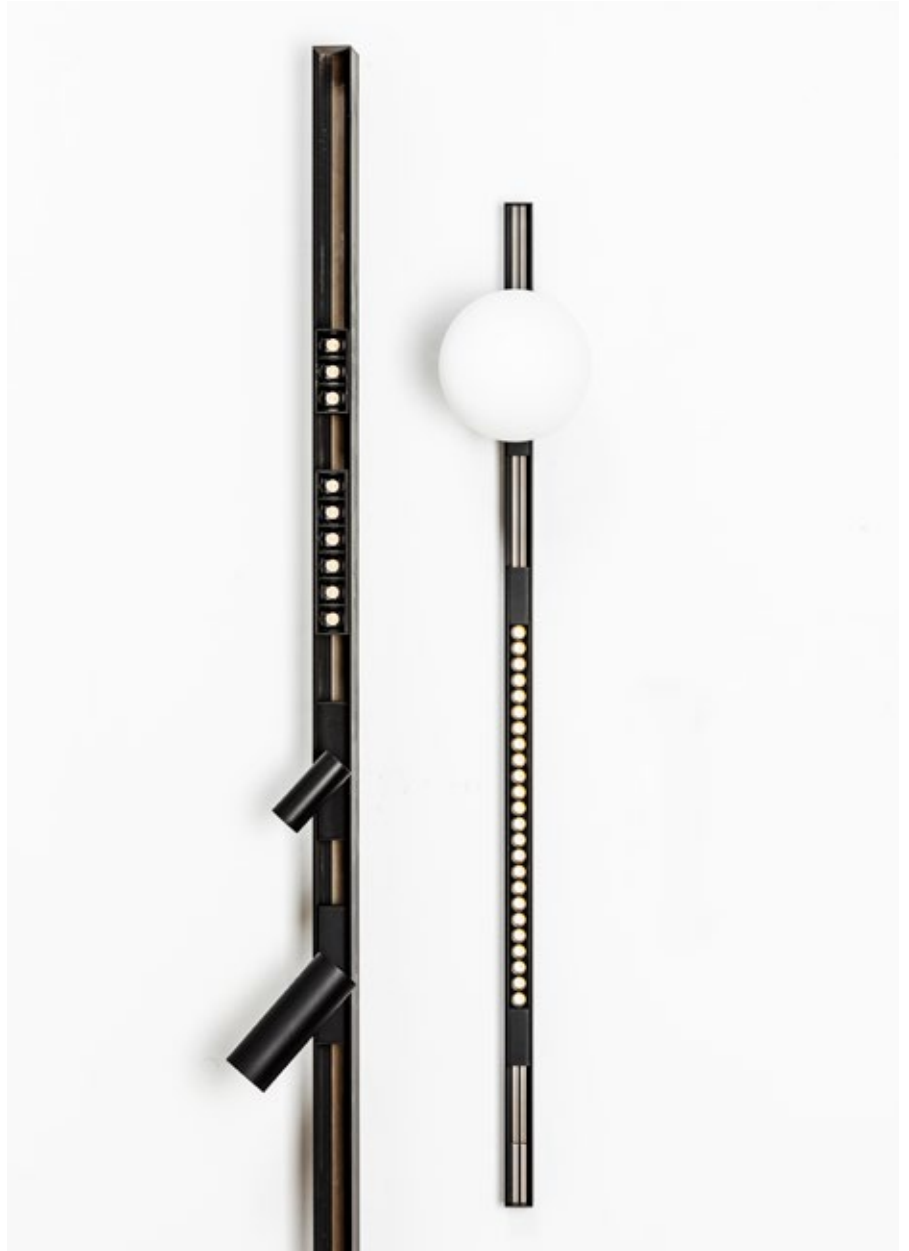

Tracklights



p.59 Blit
Track

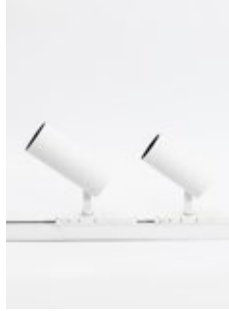

p.47 Fost
Track



p.35 Target

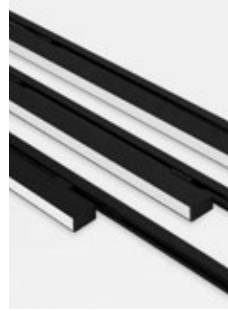

p.67 Via
Track

Downlights



p.163 Backlight



p.131 Colin



p.153 Croc



p.101 Deep

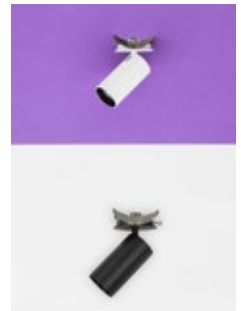

p.171 Fost
Recessed

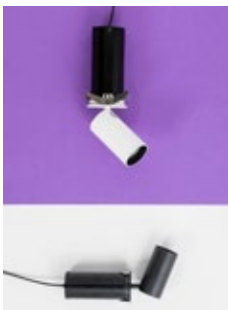

p.181 Fost
Pulldown



p.93 Kobo

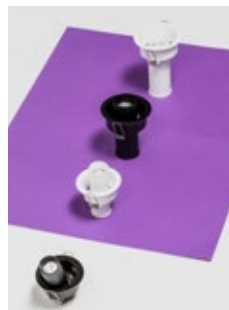

p.85 Kope

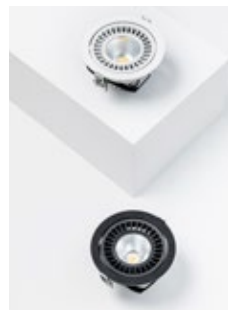

p.145 Optic

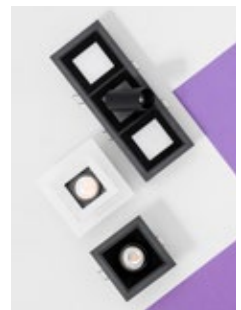

p.225 Podium



p.201 Teide



p.117 Troop



p.213 Tulipa

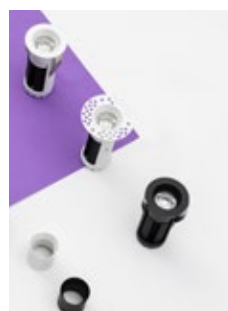

p.191 Uno

Surface



p.241 Blit
Surface



p.287 Domio



p.277 Fost
Ceiling



p.267 Fost
Surface



p.299 Podium
Surface



p.259 Proofline



p.249 Scuba

Suspended



p.323 Fost
Pendant

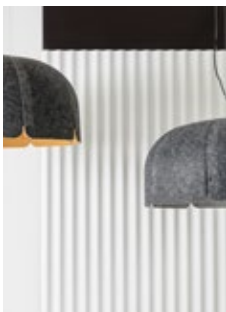

p.313 Mute
by Nahrang

Systems



p.395 Fonovia
by FaroLab



p.339 Neso

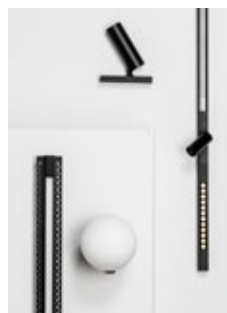

p.357 Neso Slim



p.371 Via
Evolution

Ledstrip



p.409 Ledstrip

“Faro Barcelona exists to contribute to the wellbeing and happiness of people through design and the relationship we establish with the objects that surround us in our daily lives.
We believe in honest and accessible design.
Design for everyone.”

“Faro Barcelona existe para contribuir al bienestar y la felicidad de las personas a través del diseño y la relación que establecemos con los objetos que nos rodean en nuestro día a día.
Creemos en un diseño honesto y accesible.
Diseño para todos.”

OUR PURPOSE

Xavier Martin
CEO



Espacio Princesa
Princesa 52 Barcelona



The creativity, ingenuity and design of Faro Barcelona can be found in the heart of the city. Welcome to Espacio Princesa!

La creatividad, ingenio y diseño de Faro Barcelona se encuentran en el corazón de la ciudad. ¡Bienvenido/a a Espacio Princesa!

SHOWROOM

Docontract MAD
Velázquez 35-4ºD Madrid

Showroom París
7 Rue d'Uzès París



This innovative space has emerged with the purpose of simplifying the work of architects, interior designers and developers looking for solutions for their new construction or renovation projects.

Este espacio innovador ha surgido con el propósito de simplificar el trabajo de arquitectos, diseñadores de interiores y desarrolladores que buscan soluciones para sus proyectos de construcción o renovación.



A space in which to carry out commercial activities such as visits, product demonstrations and meetings, and to develop a calendar of scheduled events to experience first-hand the design concept in lighting and ceiling fans.

Un lugar en el que realizar actividades comerciales como visitas, demostraciones de productos y reuniones, y desarrollar un calendario de eventos programados para experimentar de primera mano el concepto de diseño en iluminación y ventiladores de techo.

We planned it to be the meeting point for designers, interior designers, architects and creatives to share their concerns and create a whole experience.

Lo planeamos para que fuera el punto de encuentro de diseñadores, interioristas, arquitectos y creativos para compartir sus inquietudes y crear toda una experiencia.

SUSTAINABILITY

LIGHT THE WORLD



Discover more
Descubre más

Our purpose is to contribute to the wellbeing of people and our environment. Our sustainability journey focuses on two main objectives: reducing our negative impact on the planet and maximising our positive social impact.

Nuestro propósito es contribuir al bienestar de las personas y de nuestro entorno. Nuestro camino hacia la sostenibilidad se centra en dos grandes objetivos: reducir nuestro impacto negativo en el planeta y maximizar nuestro impacto social positivo.

PEOPLE



The value of a great team

At Faro Barcelona, sustainability starts from the inside, taking care of the well-being and personal growth of our team.

Equality and diversity

At Faro Barcelona all people are great and equal, whatever their gender, age, religion or sexual orientation. Women, equal to men, play an important role: 76% of our team and 49% of our leaders are women.

Community support

For over a decade, we have been collaborating in social projects of foundations providing our help to ensure a better quality of life for the people helped by these organisations. Since 2008, we have had our own social project with Hook, each luminaire sold feeds a child in Africa for one year.

Supporting new talent

We collaborate with universities and design schools to help new talents emerge into their professional development. Projects such as Reborn, a second life for waste (La Llotja), Design Make It with 3D printing (CIM UPC), are some of the collaborations we have carried out.

Social innovation

We take part in disruptive social innovation research and develop products and services that solve social problems such as the ageing of the population. We have a positive impact on people's quality of life, contributing to their well-being and comfort through quality, accessible and sustainable lighting and design.

El valor de un gran equipo humano

En Faro Barcelona la sostenibilidad empieza en el interior, cuidando el bienestar y crecimiento personal de nuestro equipo.

Igualdad y diversidad

En Faro Barcelona todas las personas son grandes e iguales, sean del género, edad, religión u orientación sexual que sean. La mujer, igual que el hombre, desempeña un papel importante: el 76% de nuestro equipo y el 49% de nuestros líderes son mujeres.

Apoyo a la comunidad

Durante más de una década, hemos colaborado en proyectos sociales de fundaciones, brindando nuestra ayuda para asegurar una mejor calidad de vida para las personas beneficiadas por estas organizaciones. Desde 2008, tenemos nuestro propio proyecto social con Hook; cada luminaria vendida alimenta a un niño en África durante un año.

Apoyo a los nuevos talentos

Colaboramos con universidades y centros de diseño para ayudar a los nuevos talentos en su desarrollo profesional. Proyectos como Reborn, una segunda vida para los desechos (La Llotja), Diseño Make It con impresión 3D (CIM UPC), son algunas de las colaboraciones que hemos realizado.

Innovación social

Participamos en investigaciones de innovación social disruptiva y desarrollamos productos y servicios que resuelven problemáticas sociales como el envejecimiento de la población. Impactamos positivamente en la calidad de vida de las personas, contribuyendo a su bienestar y confort a través de la iluminación y el diseño de calidad, accesible y sostenible.



CARBON FOOTPRINT CERTIFICATION

We have achieved certification of our carbon footprint calculation in accordance with the ISO 14064-1 international standard, a major milestone on our path to sustainability. Thanks to this certification, we know the real volume of greenhouse gas emissions generated by our activity and it allows us to identify areas for improvement and implement compensation strategies through different programs.

We celebrate that we have successfully passed the sustainability audit carried out by EcoVadis, obtaining the prestigious Medal in recognition of our sustainability efforts and achievements. Both certifications reaffirms our ongoing commitment to sustainability and corporate responsibility in all its facets and operations.

Hemos obtenido la certificación de nuestro cálculo de la huella de carbono de acuerdo con la norma internacional ISO 14064-1, un hito importante en nuestro camino hacia la sostenibilidad. Gracias a esta certificación, conocemos el volumen real de emisiones de gases de efecto invernadero generadas por nuestra actividad, lo que nos permite identificar áreas de mejora e implementar estrategias de compensación a través de diversos programas.

Celebramos haber superado con éxito la auditoría de sostenibilidad realizada por EcoVadis, obteniendo la prestigiosa Medalla en reconocimiento a nuestros esfuerzos y logros en sostenibilidad. Ambas certificaciones refuerzan nuestro compromiso continuo con la sostenibilidad y la responsabilidad corporativa en todas sus facetas y operaciones.

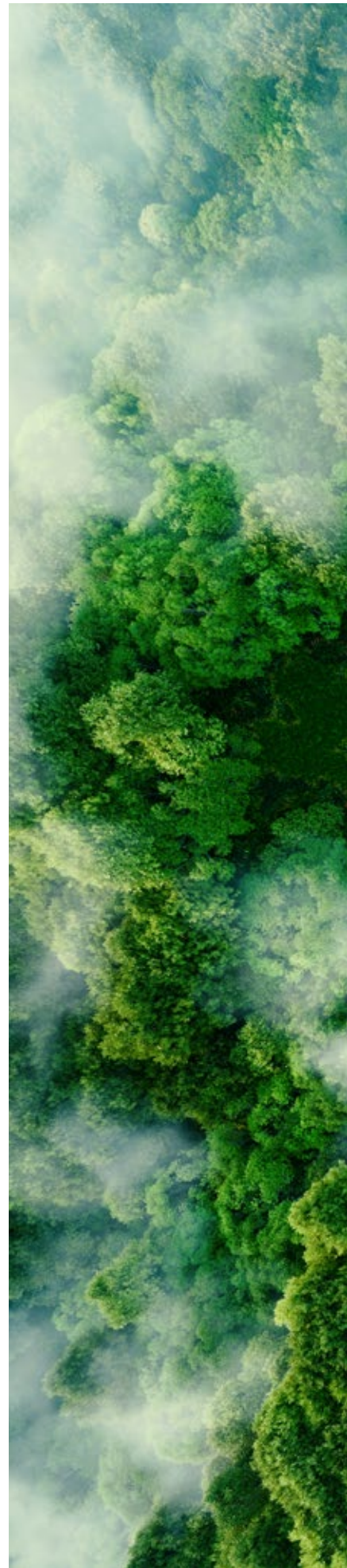



PLANET

Sustainable packaging

At Faro Barcelona, we have a sustainable packaging decalogue. Our packaging is made of recycled cardboard boxes printed in one ink and without staples to ease the disassembly and the right recycling. We have eliminated single-use plastics and replaced them with recyclable paper bags and we use recycled cardboard shavings to protect the product during transport in 60% of our shipments. All our packaging meets Drop Test ISTA-2C quality standards to ensure products arrive in perfect condition.



More sustainable logistics and transport

We have optimised the packaging size of each product to reduce the amount of packaging material and the carbon footprint of transport. FMCG products are transported in stacks, which means a greatly reduced carbon footprint. We have opened a new logistics centre in China to supply our Asia-Oceania market in a more sustainable way and reduce carbon emissions from transport.

Sustainable workspaces

We use green electricity in our offices. We produce 70% of the energy we consume with our own photovoltaic installation, ensuring that the energy is from renewable sources. In addition, our headquarters are designed to maximise the use of solar energy and natural light.

Supporting new talent Team committed to sustainability

At Faro Barcelona we have an internal sustainability committee that promotes different sustainability actions and monitors them.



Embalaje sostenible

En Faro Barcelona disponemos del decálogo de embalaje sostenible. Nuestros embalajes son cajas de cartón reciclado impresas a una sola tinta y sin grapas para facilitar así el desmontaje y su correcto reciclaje. Hemos eliminado los plásticos de un solo uso y sustituido por bolsas de papel reciclable y utilizamos virutas de cartón reciclado para la protección del producto durante el transporte en el 60% de nuestros envíos. Todos nuestros embalajes cumplen los estándares de calidad de Drop Test ISTA-2C para asegurar que los productos lleguen en perfecto estado.

Logística y transporte más sostenible

Hemos optimizado el tamaño del embalaje de cada producto para reducir la cantidad de material de embalaje y la emisión de carbono derivado del transporte. Los productos de gran consumo se transportan apilados, lo que implica una gran reducción de huella de carbono. Hemos abierto un nuevo centro logístico en China para abastecer a nuestro mercado Asia-Oceania de una forma más sostenible y reduciendo las emisiones de carbono derivadas del transporte.

Espacios de trabajo sostenibles

En nuestras oficinas utilizamos energía eléctrica verde. Producimos un 70% de la energía que consumimos con nuestra propia instalación fotovoltaica, asegurando que la energía es de fuente renovable. Además, nuestra sede cuenta con un diseño pensado para el máximo aprovechamiento de la energía solar y la luz natural.

Equipo comprometido con la sostenibilidad

En Faro Barcelona contamos con un comité de sostenibilidad interno que promueve diferentes acciones de sostenibilidad y realiza su seguimiento.



PRODUCT



Sustainability from conceptualisation

In our eco-design decalogue we set out the main guidelines we follow to make our designs more sustainable. We work with external consultants to reduce the environmental impact of our production processes, guaranteeing the quality and safety of our products. We are training our design team in circular design techniques for the more sustainable development of all our products.

A longer useful life

We work to design timeless, repairable and long-lasting products in order to reduce their environmental impact. We research new methods to ensure that our designs last longer, are easier to repair and recycle.

Standardisation and modularity

We work on the standardisation of components for a more efficient use of resources and more sustainable production. We develop modular collections that allow us greater versatility and more efficient logistics and transport.

More sustainable processes and materials

One of the major challenges towards a more sustainable production is the choice of materials as it represents more than 70% of the product's carbon footprint. The use of recycled materials or materials with a lower environmental impact, the implementation of new techniques and the reduction of the number of materials used, help us to achieve more sustainable manufacturing. Control of the supply chain

We share our sustainability vision and commitments with all our suppliers. We, therefore have a supplier code of conduct to ensure a more sustainable supply chain.

Sostenibilidad desde la conceptualización

En nuestro decálogo de eco-diseño recogemos las principales directrices que seguimos para que nuestros diseños sean más sostenibles. Trabajamos con asesorías externas para reducir el impacto ambiental de nuestros procesos productivos, garantizando la calidad y seguridad de nuestros productos. Estamos formando a nuestro equipo de diseño en técnicas de diseño circular para el desarrollo más sostenible de todos nuestros productos.

Una mayor vida útil

Trabajamos en el diseño de productos atemporales, reparables y duraderos con el fin de reducir su impacto medioambiental. Investigamos nuevos métodos para garantizar que nuestros diseños sean más duraderos, fáciles de reparar y de reciclar.

Estandarización y modularidad

Trabajamos en la estandarización de componentes para un uso más eficiente de los recursos y una producción más sostenible. Desarrollamos colecciones modulares que nos permiten mayor versatilidad y una logística y transporte más eficientes.

Procesos y materiales más sostenibles

Uno de los grandes retos hacia una producción más sostenible es la elección de los materiales ya que representa más del 70% de la huella de carbono del producto. El uso de materiales reciclados o con menor impacto ambiental, la implementación de nuevas técnicas y la reducción del número de materiales usados, nos ayuda a conseguir una fabricación más sostenible.

Control de la cadena de suministro

Compartimos nuestra visión y compromisos de sostenibilidad con todos nuestros proveedores. Por ello, disponemos del código de conducta de proveedores para garantizar una cadena de suministro más sostenible.



At Faro Barcelona we control the quality of our products and services at all stages: from conception and design to functionality and reliability tests.

We have implemented a quality management system based on ISO9001.

Legislative compliance with safety regulations under EN60598 and ERP energy efficiency regulations.

We work with leading brands of components, equipment and optics (Tridonic, TCI, Vossloh, Osram, Citizen, CREE, Bridgelux, LEDil). All our products are guaranteed for 5 years and are assembled at our headquarters.

En Faro Barcelona controlamos la calidad de nuestros productos y servicios en todas las fases: desde la concepción y el diseño hasta los ensayos de funcionalidad y fiabilidad. Hemos implementado un sistema de gestión de calidad basado en la ISO9001. Cumplimiento legislativo de las normativas de seguridad bajo la EN60598 y la normativa de eficiencia energética ERP. Trabajamos con las primeras marcas de componentes, equipos y ópticas (Tridonic, TCI, Vossloh, Osram, Citizen, CREE, Bridgelux, LEDil)

Todos nuestros productos tienen una garantía de 5 años y son ensamblados en nuestra sede.

Parametrical Lab

Specification Compliance
Electrical Safety Tests
Integrating Sphere
Climatic Chamber
IK Tests

Environmental Testing Lab

Water IP Tests
Powder IP Tests
Salt Spray Chamber

Technical Assistance Service (TAS)

Customer Returns Analysis
Customer Returns Repairs
TAS Spare Parts

Quality inspections Lab

Batch inspections
Functional Tests
Product Assembly Control
Product Finish Control

Ceiling Fan Lab

Life Test
Customizations
Airflow measurements
Noise measurements

Goniophotometer Room

Q-LAB

QUALITY & INNOVATION



Climatic Chamber
Cámara climática



Goniophotometer Room
Sala de Gonioplómeto

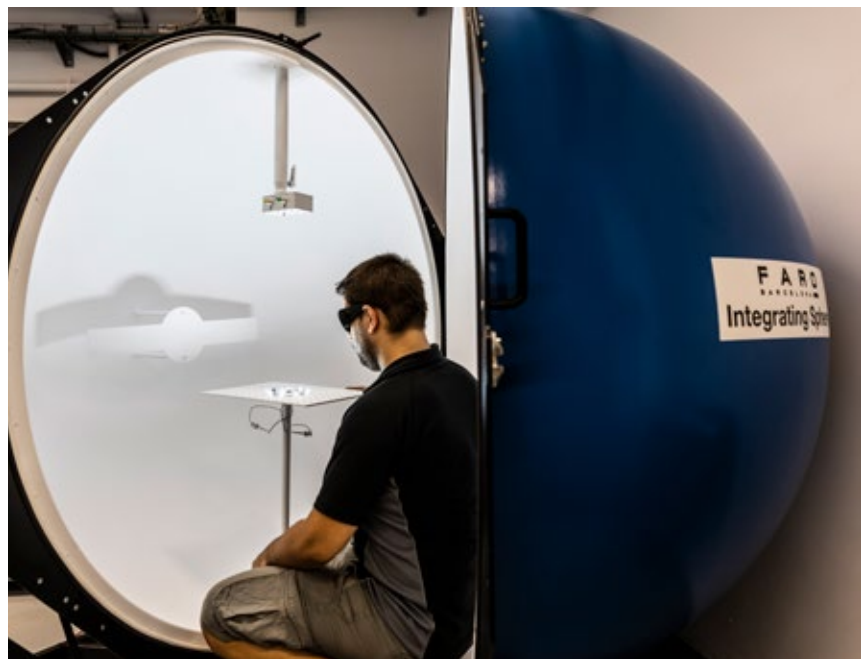

Integrating Sphere
Esfera Integradora

Assistance during installation
Acompañamiento
en instalación y obra

Consultancy and Advice
Consultoría y Asesoramiento

**Product
customisation**
Personalización
de productos

**Lighting
projects**

**Lighting
calculations**
Cálculos
lumínicos

**Digital documentation: Dialux
(ULD, IES, LDT) Revit / BIM
(RFA) 3D files, IGS (SketchUp)**
Documentación digital: Dialux
(ULD, IES, LDT) Revit / BIM
(RFA) 3D files, IGS (SketchUp)

Advice on product selection
Asesoramiento en selección de
productos

**Lighting and fan projects
department**
Departamento de proyectos de
iluminación y ventilación

Incident management
Gestión de incidencias

**Technical
service**

**Custom &
Special developments**

Technical support service
Servicio de atención técnica

Remote access to installations for configuration / changes
Acceso remoto a las instalaciones para configuración / cambios

Remote installation management
Gestión remota de instalaciones

Energy consumption monitoring
Monitorización de consumo energético

Scene and group definition
Definición de escenas y grupos

Turnkey project
Proyecto llave en mano

**Control
& Connectivity**

Scalable installations
Instalaciones escalables

Plug&Play equipment configuration for luminaires
Configuración de equipos para luminarias Plug&Play

System Control design and planning
Diseño y planificación del sistema de control

Automation (sensors, timetables, circadian cycle)
Automatización (sensores, horarios, ciclo circadiano)

Solutions to connect to the control system (wired, wireless or remote devices)
Soluciones para conectarse al sistema de control (dispositivos cableados, inalámbricos o remotos)

SERVICES

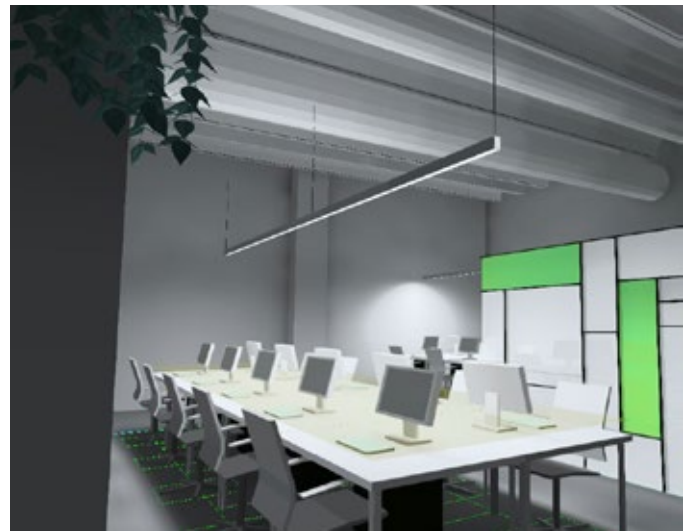
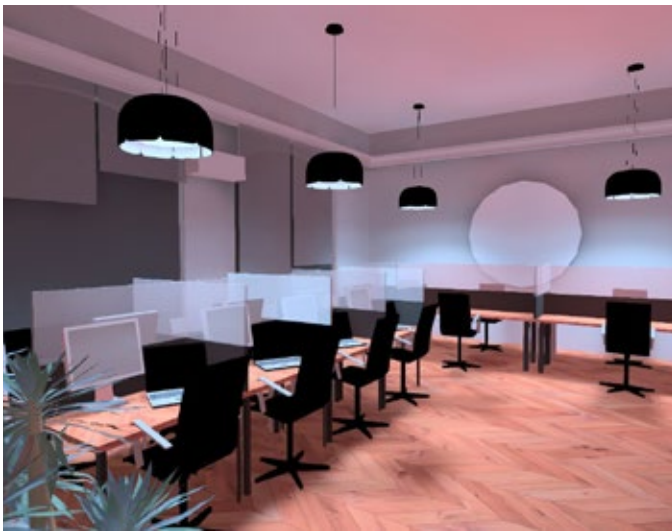
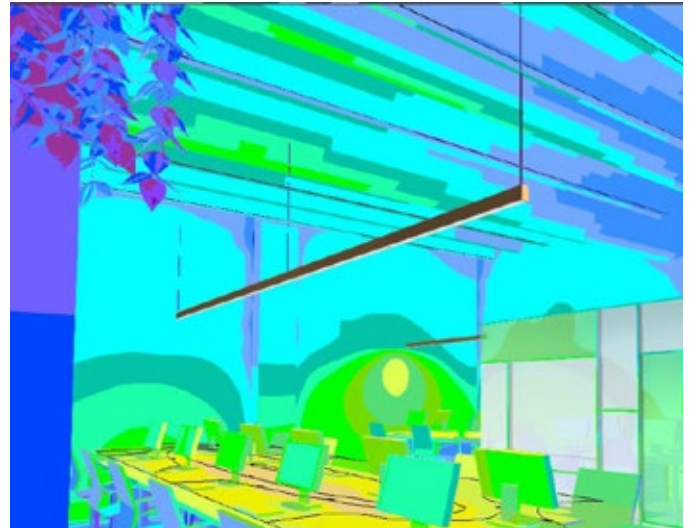
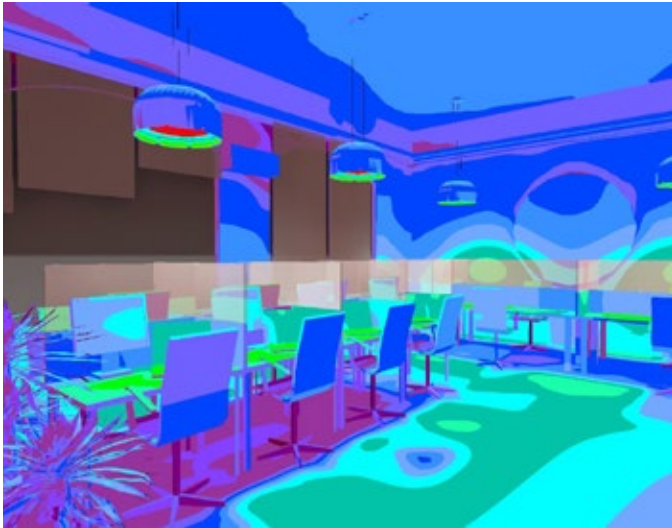

At Faro Barcelona we put at your disposal our great team of lighting and interior designers to advise you in your lighting projects, both with the interpretation of the client's needs, the calculations and documentation of the project, and with personalised advice and a complete follow-up of the project from conceptualisation to implementation. All this with a special sensitivity to the care of the environment, architectural enhancement and customer satisfaction, taking into account aesthetic values and trends.

En Faro Barcelona ponemos a tu disposición nuestro gran equipo de expertos en lighting design e interiorismo y te acompañamos en tus proyectos de iluminación, tanto con la interpretación de las necesidades del cliente, la realización de cálculos y documentación del proyecto junto con una asesoría personalizada y un seguimiento completo del proyecto desde la conceptualización a la implementación. Todo ello con una sensibilidad especial en el cuidado del entorno, realce arquitectónico y satisfacción del cliente, teniendo en cuenta valores estéticos y de tendencias.

LIGHTING PROJECTS

PROYECTOS DE ILUMINACIÓN

Need consulting for your project?
¿Necesitas asesoramiento para tu proyecto?



Harnessing our expertise and professionalism, we customise products and develop made-to-order and unique solutions.

CUSTOM & SPECIAL DEVELOPMENTS

PERSONALIZACIONES Y DESARROLLOS ESPECIALES

Nuestra experiencia y profesionalidad nos permite realizar personalizaciones de producto así como desarrollar soluciones únicas para cada proyecto.

WELL-BEING

Your customers are looking for pleasant, comfortable and enjoyable sensations and experiences that can be easily programmed and guaranteed.



EL BIENESTAR DE LAS PERSONAS

Tus clientes buscan sensaciones y experiencias agradables, cómodas y placenteras que puedan ser fácilmente programadas y garantizadas.

EFFICIENCY AND SUSTAINABILITY

Scheduling and automation allow us to minimise energy costs and therefore the impact on the environment.



EFICIENCIA Y SOSTENIBILIDAD

La programación y la automatización nos permiten minimizar los costes energéticos y el impacto en el medio ambiente.

FLEXIBILITY AND CUSTOMIZATION

Get the maximum level of flexibility in your project. Spaces with customised configuration settings in a convenient and simple way.



FLEXIBILIDAD Y CUSTOMIZACIÓN

Obtén el máximo nivel de flexibilidad en tu proyecto. Espacios con ajustes de configuración personalizados de forma cómoda y sencilla.

GUARANTEE THE BEST EXPERIENCE

Technology helps us to meet the needs and demands of our customers and thus ensure a better experience in the spaces they live in.



LA MEJOR EXPERIENCIA

La tecnología nos ayuda a satisfacer las necesidades y exigencias de nuestros clientes y garantizar, así, una mejor experiencia en los espacios que habitan.

At Faro Barcelona we know the benefits of quality light at the service of people's well-being. For this reason, we design luminaires and connectivity solutions that apply the latest technology to achieve this purpose.

CONTROL & CONNECTIVITY

SMART LIGHTING

En Faro Barcelona tenemos muy presente los beneficios de una luz de calidad al servicio del bienestar de las personas. Por ello, diseñamos luminarias y soluciones de conectividad que aplican la última tecnología para conseguir este propósito.

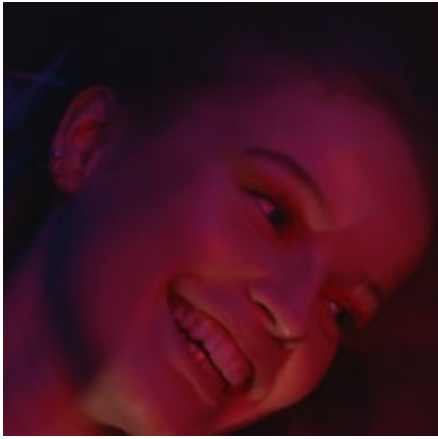

INCREASES PHYSICAL AND EMOTIONAL WELL-BEING
INCREMENTA EL BIENESTAR FÍSICO Y EMOCIONAL



IMPROVES SLEEP CYCLE
MEJORA EL CICLO DEL SUEÑO



INCREASES EFFICIENCY
MEJORA EL RENDIMIENTO

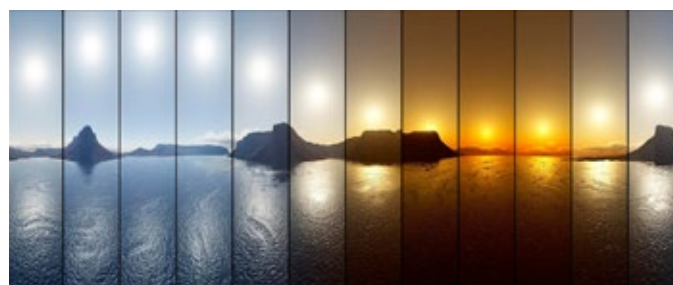
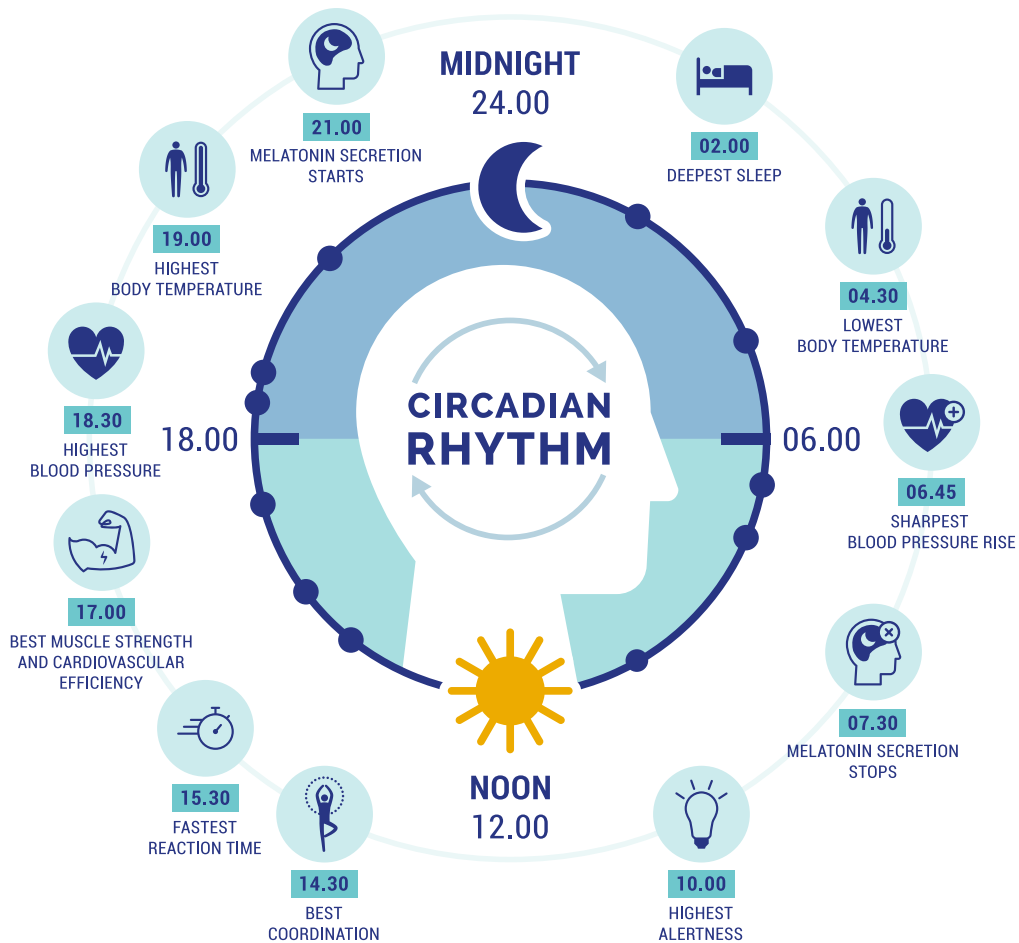

Light profoundly affects our well-being. Our products prioritize the non-visual impact of light, promoting health. We emphasize Human Centric Lighting (HCL), replicating natural light rhythms. Artificial lighting mirrors sunlight's movement, intensity, and color, aligning with our circadian cycle.

Understanding light as a crucial life element, we develop solutions for holistic health, ensuring our well-being aligns with the dynamic qualities of natural light.

INTEGRATIVE LIGHTING

LUZ INTEGRADORA

La luz tiene un impacto directo en nuestro estado físico y emocional. Nuestros productos y soluciones se desarrollan teniendo en cuenta los efectos no visuales de la luz, en beneficio de la salud y el bienestar de las personas.

Aplicamos el concepto de Iluminación Centrada en el Ser Humano (HCL) en nuestras soluciones, mejorando los efectos que la luz tiene en las personas y reproduciendo los ritmos de la luz natural en la iluminación artificial. Nuestro ciclo circadiano puede ser reproducido con iluminación artificial y dinámica que corresponda al movimiento, intensidad y color del sol.

PHOTOBIOLOGICAL RISK

We develop our luminaires by selecting the highest quality light sources and working the optical compartments in order to be able to offer RG0 products, free of photobiological risk.

The European standard for photobiological safety EN 62471 establishes a method for assessing the risk of eye or skin damage from a lamp or luminaire.



RIESGO FOTBIOLÓGICO

Desarrollamos nuestras luminarias seleccionando fuentes de luz de la máxima calidad y trabajando los bloques ópticos para poder ofrecer productos RG0, exentos de riesgo fotobiológico.

La norma europea de seguridad fotobiológica EN 62471 establece un método para evaluar el riesgo de daño ocular o dermatológico de una lámpara o luminaria.

FLICKER FREE

Flicker is a visible and repetitive change in light intensity caused mostly by voltage fluctuations. At Faro Barcelona we select our drivers with the guarantee of leading European brands, ensuring a good regulation and adjustment of the electricity flow, without temperature changes altering its operation.



LIBRE DE FLICKER

El flicker es un cambio visible y repetitivo en la intensidad de la luz causado en su mayoría por las fluctuaciones de voltaje. En Faro Barcelona seleccionamos nuestros drivers con la garantía de primeras marcas europeas, asegurando una buena regulación y ajuste del flujo de electricidad, sin que los cambios de temperatura alteren su funcionamiento.

CRI

The colour rendering index (CRI) is a quantitative measure that indicates the ability of a light source to faithfully reproduce colours compared to a natural light source.

Our luminaires have high CRI to ensure the best colour rendering.



IRC

El índice de reproducción cromática (IRC) es una medida cuantitativa que indica la capacidad que tiene una fuente de luz para reproducir fielmente los colores en comparación con una fuente de luz natural.

Nuestras luminarias presentan altos IRC para garantizar la mejor reproducción cromática.

UGR

Glare negatively affects people's well-being and productivity.

Our solutions guarantee a high level of visual comfort - with diffuser options microprism, precise lens and optics combinations - for better light control and glare reduction.

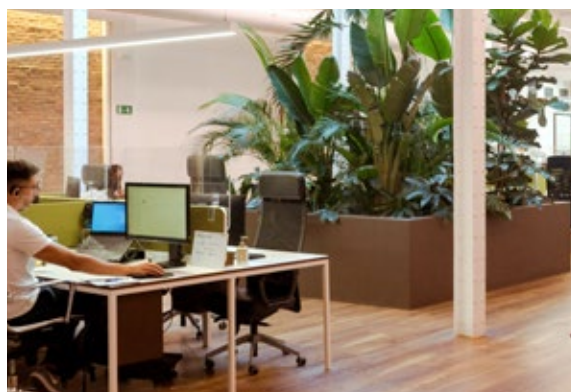

UGR

El deslumbramiento afecta negativamente al bienestar y la productividad de las personas. Nuestras soluciones garantizan un alto confort visual -con opciones de difusor microprismático, combinación precisa de lentes y ópticas- para un mejor control lumínico y reducción del deslumbramiento.



Light is an indispensable element in the perception of our environment: it influences how we perceive space and what emotions it generates in us. It is the regulator of our biorhythms, capable of stimulating, relaxing or activating our organism, directly affecting our well-being-mood, sleep cycles, performance.

HEALTHY LIGHTING

ILUMINACIÓN SALUDABLE

La luz es un elemento indispensable en la percepción de nuestro entorno: influye en cómo percibimos el espacio y qué emociones nos genera. Es la reguladora de nuestros biorritmos, capaz de estimular, relajar o activar nuestro organismo, afectando de forma directa a nuestro bienestar -estado de ánimo, ciclos de sueño, rendimiento-.

Nuestros productos LEAF son luminarias especiales diseñadas para potenciar el crecimiento de plantas de interior.
 Estos productos resultan ideales para crear entornos biofílicos con escasa iluminación natural.
 Our LEAF products are special luminaires designed to enhance the growth of indoor plants.
 These products are ideal for creating biophilic environments with low natural light.

BIOPHILIA

Connecting with nature is crucial for well-being. We've developed models promoting biophilic indoor design, integrating nature elements for calmness and well-being. Common in offices, restaurants, and hotels, green spaces require special lighting for vegetation maintenance.



BIOFILIA

Conectar con la naturaleza es crucial para el bienestar. Hemos desarrollado modelos que promueven el diseño biofílico en interiores, integrando elementos naturales para la calma y el bienestar. Común en oficinas, restaurantes y hoteles, los espacios verdes requieren iluminación especial para el mantenimiento de la vegetación.

LIGHT SPECTRUM

LEDs allow precise light spectrum customization for plants, meeting varied growth stages. Tailor colors to enhance vegetative growth or encourage flowering and fruiting. Typically, red and blue lights promote growth, while green and white lights aid in flowering and fruit development.



ESPECTRO DE LUZ

Los LEDs permiten la personalización precisa del espectro de luz emitida para las plantas, cubriendo diversas etapas de crecimiento. Adapta los colores para potenciar el crecimiento vegetativo o fomentar la floración y fructificación. Por lo general, las luces rojas y azules impulsan el crecimiento, mientras que las luces verdes y blancas ayudan en el desarrollo de flores y frutos.

PHOTON FLUX DENSITY

PFD (photons/m²/s) is a crucial metric, measuring light available for photosynthesis with consideration for the spectrum's impact on plant growth. Typically falling within the range of 50-150 $\mu\text{mol}/\text{m}^2/\text{s}$, this metric guides the provision of optimal light for healthy growth.



DENSIDAD DE FLUJO DE FOTONES

PFD (fotones/m²/s) es una métrica crucial, midiendo la luz disponible para la fotosíntesis con consideración del impacto del espectro en el crecimiento de las plantas. Generalmente, oscilando entre 50-150 $\mu\text{mol}/\text{m}^2/\text{s}$, esta métrica guía la provisión de luz óptima para el crecimiento saludable.

FEATURES OF OUR LEAF LIGHT SOURCES

Higher infrared emission (> 700 nm): Benefits photosynthesis and growth. Green emission (500-560 nm): Essential for vegetative growth, absorbed by chloroplasts, triggering physiological responses for healthy plant development.

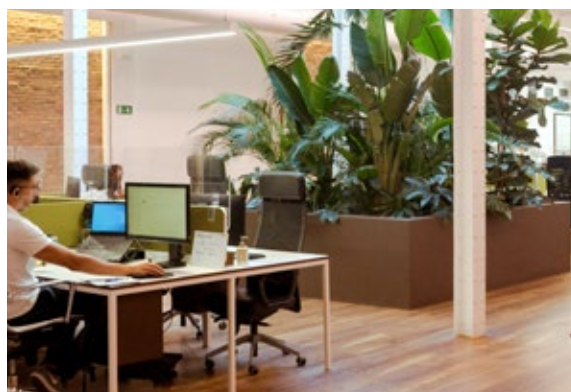

CARACTERÍSTICAS DE NUESTRAS FUENTES DE LUZ LEAF

Mayor emisión infrarroja (> 700 nm): Beneficia la fotosíntesis y el crecimiento. Emisión verde (500-560 nm): Esencial para el crecimiento vegetativo, absorbida por los cloroplastos, desencadenando respuestas fisiológicas para el desarrollo saludable de las plantas.

LEAF

LEAF products: Target on page 35. VIA on page 67
 Productos LEAF: Target página 35. VIA página 67

Light is essential not only for human well-being but also for plant growth in biophilic spaces. Its role encompasses supporting photosynthesis and plant development, acting as a dual regulator by influencing human biorhythms and emotional states while nourishing the vitality of plants. This harmonious interaction enhances the overall biophilic experience.

BIOPHILIC SPACES

ESPACIOS BIOFÍLICOS

La luz es esencial tanto para el bienestar humano como para el crecimiento de las plantas en espacios biofílicos. Su papel abarca el respaldo de la fotosíntesis y el desarrollo vegetal, actuando como regulador dual al influir en biorritmos y estados emocionales humanos, al mismo tiempo que nutre la vitalidad de las plantas. Esta interacción armónica potencia la experiencia



T R A C K L I G H T S

Less is more. The design of the TARGET track projector achieves the minimum expression of visual volume, making the place appear spacious and bringing the architecture and the elements to be lit to the forefront. Its wide range of colour temperature, different optics and high CRI options makes it a perfect option for commercial spaces, hotels, restaurants and retail.

Menos es más. El diseño del proyector a carril TARGET logra la mínima expresión del volumen visual, dotando de amplitud al lugar y cediendo el protagonismo a la arquitectura y los elementos a iluminar. Su amplia gama de temperaturas de color, diversas ópticas y opciones de alto IRC lo convierten en una opción perfecta para espacios comerciales, hoteles, restauración y retail.



TARGET





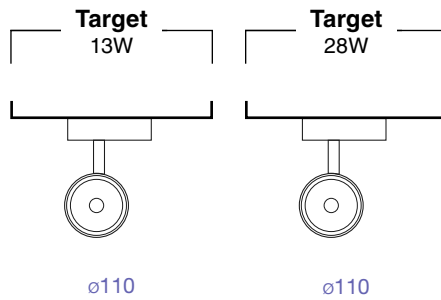

FINISH
Acabado

● **Black**
Negro

○ **White**
Blanco

COLOR TEMPERATURE
Temperatura de color

2700K CRI90

3000K CRI90

4000K CRI90

2700K CRI97

3000K CRI97

4000K CRI97

MEAT

BREAD

FASHION

LEAF*

BEAM ANGLE
Ángulo de apertura

15°

35°

ACCESSORIES
Accesorios



Honeycomb



Striped Glass



Long Snoot

CONTROL SYSTEM
Sistema de control



CASAMBI

* Leaf. More information on page 31

* Leaf. Más información en la página 31

Highlights



Accessory

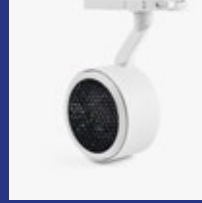

Honeycomb

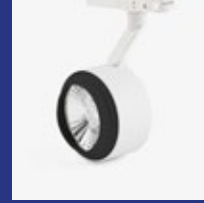

Long Snout



Striped Glass



Built-in track
Equipo built-in en adaptador



High CRI
Alto IRC



Several color temperatures
Varias temperaturas de color



LEAF: Light source for plant growth.
LEAF: Fuente de luz para crecimiento de plantas.



**Need consulting
for your project?**
¿Necesitas
asesoramiento
para tu proyecto?



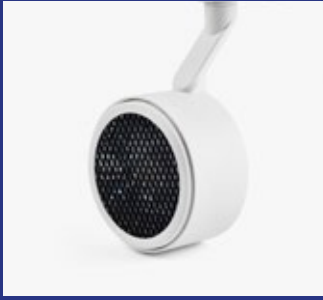

Honeycomb



Long Snout



Striped Glass



Striped Glass

Accessories

Honeycomb	Long Snout	Striped Glass
● 011400098		● 011400097
● 011400096	● 011400099	● 011400095



Restaurant

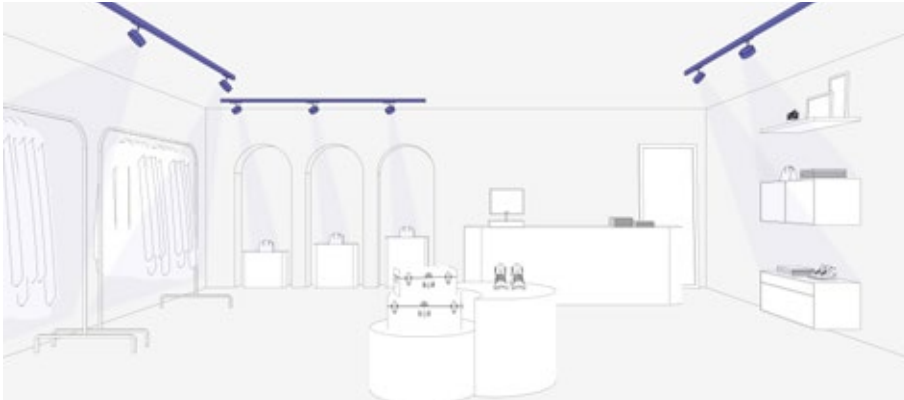

Retail

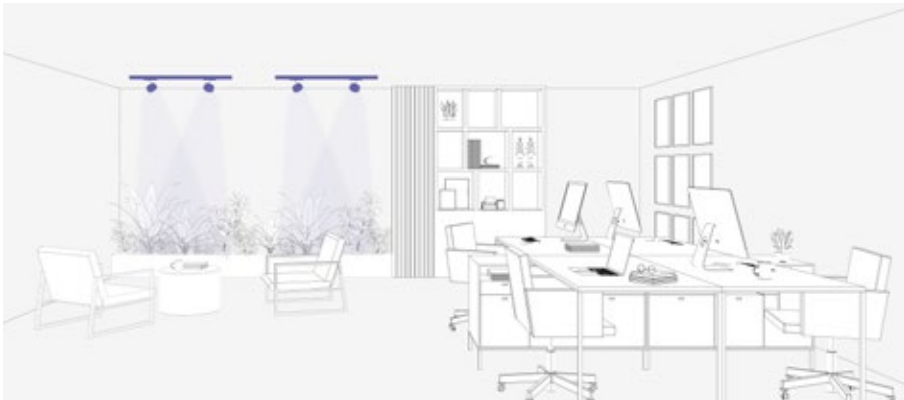

Office

Beam Angle



15°



35°

TARGET 13W

NEW

incl. DIM 355° 90° 50.000hs L70 / B10 MacAdam 2&3 220-240V 50 / 60Hz 650°C

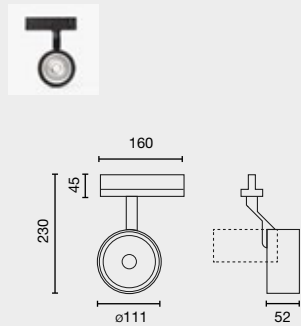

Family	Color T°	Beam Angle	Finish	Control System
0214 Target 13W	927 2700K CRI90	1 15° 3 35°	1 White	W CASAMBI D BALI ON/OFF
	930 3000K CRI90		2 Black	
	940 4000K CRI90			
	X27 2700K CRI97			
	X30 3000K CRI97			
	X40 4000K CRI97			
	MT MEAT			
	BR BREAD			
	FS FASHION			
	N LF LEAF			

0214 927 1 1 W

Example 021492711W — Target13W 2700K CRI90 15° White Casambi

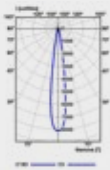

15°

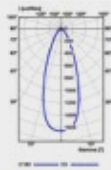

35°

Option	Color T°	CRI	Power	Lumen Output	Beam Angle
927	2700K	90	13W	970 / 1048lm	15° / 35°
x27		97	13W	872 / 943lm	15° / 35°
930	3000K	90	13W	1000 / 1080lm	15° / 35°
x30		97	13W	900 / 972lm	15° / 35°
940	4000K	90	13W	1029 / 1113lm	15° / 35°
x40		97	13W	927 / 1001lm	15° / 35°
MT	3100K	-	13W	1143 / 1226lm	15° / 35°
BR	2500K	-	13W	847 / 909lm	15° / 35°
FS	3100K	-	13W	1168 / 1253lm	15° / 35°
LF	2700K	-	13W	665 / 693lm	15° / 35°



TARGET 28W

incl. DIM 355° 90° 50.000hs L70 / B10 MacAdam 2&3 220-240V 50 / 60Hz 650°C

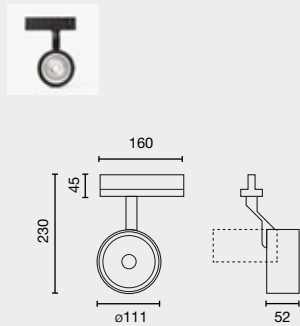

Family

Color T°

Beam Angle

Finish

Control System

0114 Target 28W

- 927 2700K CRI90
- 930 3000K CRI90
- 940 4000K CRI90
- X27 2700K CRI97
- X30 3000K CRI97
- X40 4000K CRI97

- 1 15°
- 3 35°

- 1 White
- 2 Black

- W CASAMBI
- D DALI
- ON/OFF

- MT MEAT
- BR BREAD
- FS FASHION
- N LF LEAF

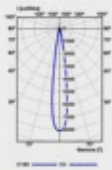

15°

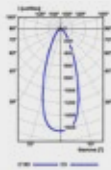

35°

Option	Color T°	CRI	Power	Lumen Output	Beam Angle
927	2700K	90	28W	2311lm / 2157lm	15° / 35°
X27	2700K	97	28W	2079lm / 1941lm	15° / 35°
930	3000K	90	28W	2382lm / 2224lm	15° / 35°
X30	3000K	97	28W	2144lm / 2001lm	15° / 35°
940	4000K	90	28W	2453lm / 2291lm	15° / 35°
X40	4000K	97	28W	2208lm / 2061lm	15° / 35°
MT	3100K	-	28W	2723lm / 2523lm	15° / 35°
BR	2500K	-	28W	2018lm / 1871lm	15° / 35°
FS	3100K	-	28W	2783lm / 2579lm	15° / 35°
LF	2700K	-	28W	1584lm / 1426lm	15° / 35°



The FOST TRACK family of track projectors was born to meet the need to accentuate what needs to be highlighted. A minimalist design that is easy to integrate into any space, bringing the architecture to the forefront. The location of the driver in the actual track adaptor facilitates this integration.

La familia de proyectores a carril FOST TRACK nace para dar respuesta a la necesidad de poner acento a lo que debe ser destacado. Un diseño minimalista de fácil integración en cualquier espacio dando protagonismo a la arquitectura. La ubicación del driver en el propio adaptador a carril facilita esta integración.



F O S T



T R A C K



FOST Collection



Recessed
171



Pulldown
181



Ceiling
277



Surface
267



Pendant
323

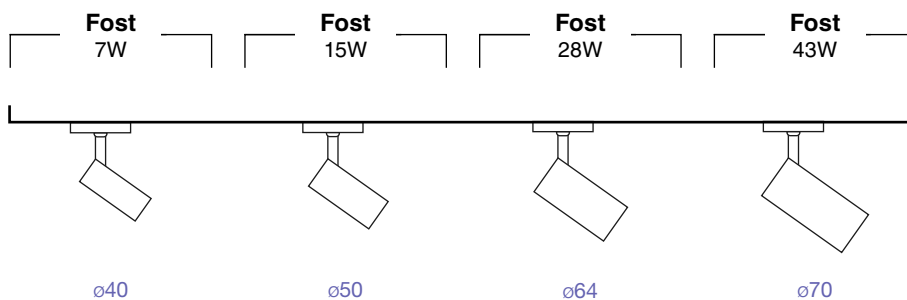

FINISH
Acabado

● **Black**
Negro

○ **White**
Blanco

COLOR TEMPERATURE
Temperatura de color

2700K CRI90	3000K CRI90	4000K CRI90
2700K CRI97	3000K CRI97	4000K CRI97
MEAT	BREAD	FASHION

BEAM ANGLE
Ángulo de apertura

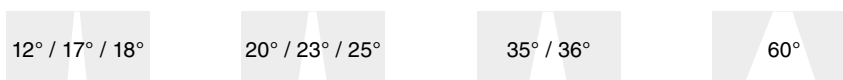

ACCESSORIES
Accesorios

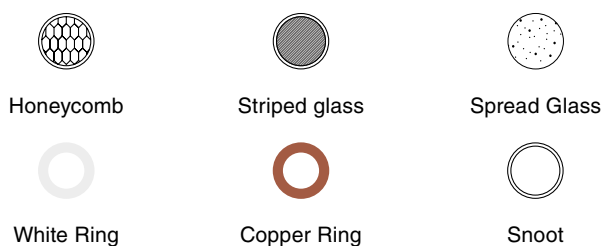

CONTROL SYSTEM
Sistema de control



Highlights

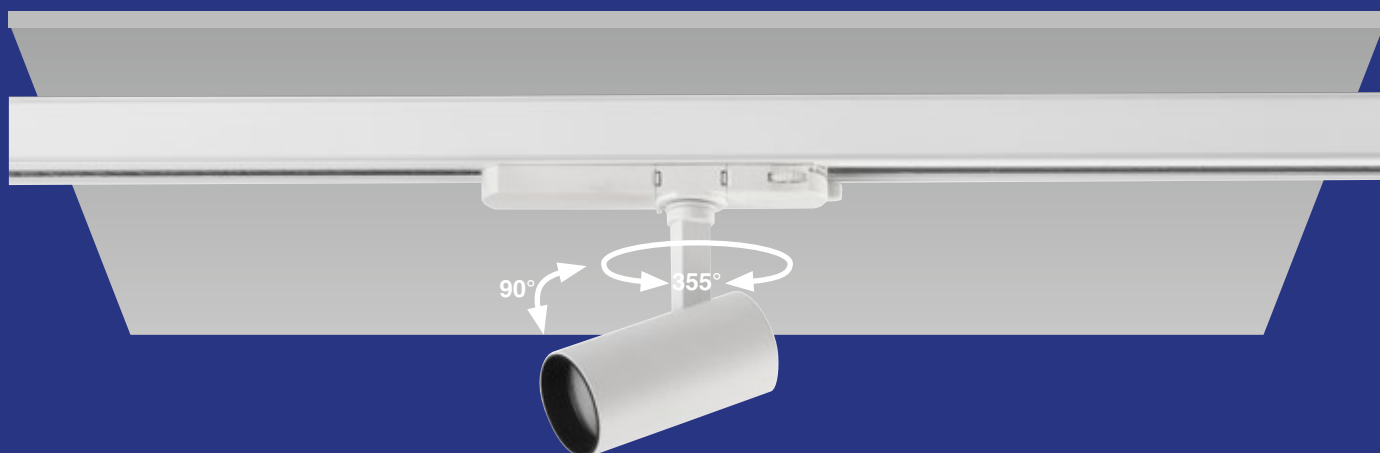

Its versatility of sizes and optics makes it an ideal solution for commercial spaces, hotels, restaurants, retail and even domestic spaces due to its colour temperature and CRI options.

Su versatilidad en tamaños y ópticas lo convierten en una solución ideal para espacios comerciales, hoteles, restaurantes, retail e incluso espacios domésticos por sus opciones en temperatura de color y IRC.



Different sizes
Diversos tamaños



Built-in track
Equipo built-in en adaptador



High CRI
Alto IRC



Several color temperatures
Varias temperaturas de color





White Ring



Copper Ring



Striped Glass

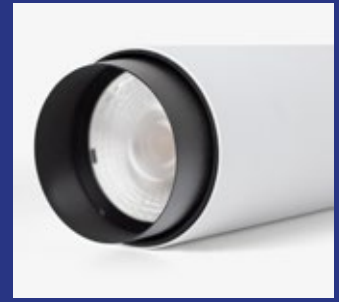

Long Snoot

Its multiple accessories and combinations facilitate the product's personalisation, giving it certain architectural relevance and at the same time making it possible to modify the beam or reduce glare.

Sus múltiples accesorios y combinaciones facilitan la personalización del producto que hace posible la modificación de haz o reducir el deslumbramiento.



Spread Glass



Honeycomb



Without accessory



Spread Glass



Striped Glass

Accesorios

	Honeycomb	White Ring	Copper Ring	Spread Glass	Long Snoot	Striped Glass
ø40	-	011500099	011500098	-	-	-
ø50	-	011600099	011600098	-	-	-
ø64	011700094	011700099	011700098	011700097	011700095	011700096
ø70	011800094	011800099	011800098	011800097	011800095	011800096

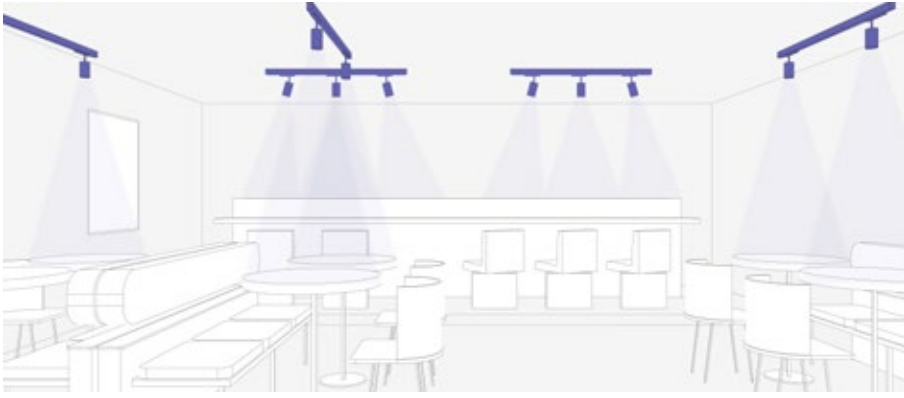

Restaurant

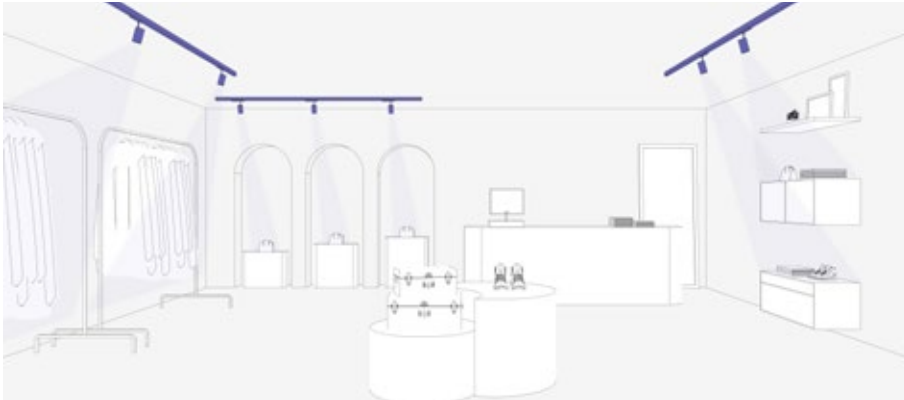

Retail

Beam Angle



12/17/18°

20/23/25°

35/36°

60°

FOST TRACK 40

incl. DIM 355° 90° 50.000hs L70 / B10 MacAdam 2&3 220-240V 50 / 60Hz 650°C

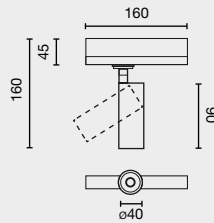

Family	Color T°	Beam Angle	Finish	Control System
0115 Fost Track ø40 7W	927 2700K CRI90	1 18°	1 White	W CASAMBI D DALI ON/OFF
	930 3000K CRI90	2 23°	2 Black	
	940 4000K CRI90	3 35°		
	X27 2700K CRI97			
	X30 3000K CRI97			
	X40 4000K CRI97			

0115 927 1 1 W

Example 011592711W — Fost Track ø40 7W 2700K CRI90 18° White Casambi

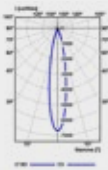

18°

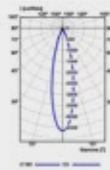

23°

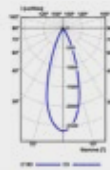

35°

Option	Color T°	CRI	Power	Lumen Output	Beam Angle
927	2700K	90	7W	632lm / 553lm / 586lm	18° / 23° / 35°
X27		97	7W	569lm / 498lm / 527lm	
930	3000K	90	7W	652lm / 570lm / 604lm	18° / 23° / 35°
X30		97	7W	587lm / 513lm / 544lm	
940	4000K	90	7W	672lm / 587lm / 622lm	18° / 23° / 35°
X40		97	7W	604lm / 528lm / 560lm	

FOST TRACK 50

incl. DIM 355° 90° 50.000hs L70 / B10 MacAdam 2&3 220-240V 50 / 60Hz 650°C

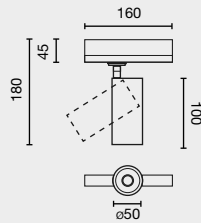

Family

Color T°

Beam Angle

Finish

Control System

0116 Fost Track ø50 15W

- 927** 2700K CRI90
- 930** 3000K CRI90
- 940** 4000K CRI90
- X27** 2700K CRI97
- X30** 3000K CRI97
- X40** 4000K CRI97

- 1** 20°
- 2** 26°
- 3** 36°

- 1** White
- 2** Black

W CASAMBI
 D DALI
 ON/OFF
 N TRIAC

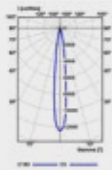

20°

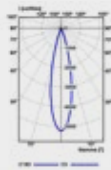

26°

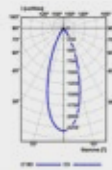

36°

Option	Color T°	CRI	Power	Lumen Output	Beam Angle
927	2700K	90	15W	1235lm / 1257lm / 1303lm	20° / 26° / 36°
X27		97	15W	1111lm / 1131lm / 1172lm	20° / 26° / 36°
930	3000K	90	15W	1273lm / 1295lm / 1343lm	20° / 26° / 36°
X30		97	15W	1146lm / 1166lm / 1209lm	20° / 26° / 36°
940	4000K	90	15W	1311lm / 1334lm / 1383lm	20° / 26° / 36°
X40		97	15W	1180lm / 1201lm / 1245lm	20° / 26° / 36°

FOST TRACK 64

incl. DIM 355° 90° 50.000hs L70 / B10 MacAdam 2&3 220-240V 50 / 60Hz 650°C

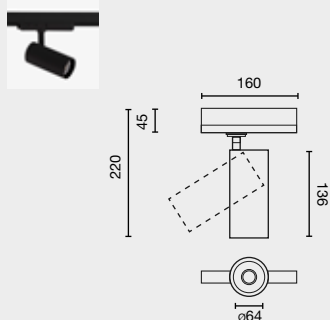

Family

Color T°

Beam Angle

Finish

Control System

0117 Fost Track ø64 28W

- 927** 2700K CRI90
- 930** 3000K CRI90
- 940** 4000K CRI90
- X27** 2700K CRI97
- X30** 3000K CRI97
- X40** 4000K CRI97

- 1** 17°
- 2** 25°
- 3** 35°
- 6** 60°

- 1** White
- 2** Black

- W** CASAMBI
- D** DALI
- ON/OFF**
- C** TRIAC

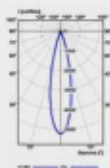

17°

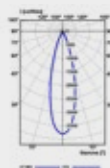

25°

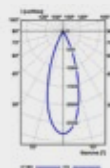

35°



60°

Option	Color T°	CRI	Power	Lumen Output	Beam Angle
927	2700K	90	28W	2982lm / 2987lm / 2732lm / 2270lm	17° / 25° / 35° / 60°
X27	2700K	97	28W	2684lm / 2688lm / 2459lm / 2043lm	17° / 25° / 35° / 60°
930	3000K	90	28W	3075lm / 3080lm / 2817lm / 2341lm	17° / 25° / 35° / 60°
X30	3000K	97	28W	2767lm / 2771lm / 2535lm / 2107lm	17° / 25° / 35° / 60°
940	4000K	90	28W	3167lm / 3172lm / 2902lm / 2412lm	17° / 25° / 35° / 60°
X40	4000K	97	28W	2850lm / 2855lm / 2611lm / 2170lm	17° / 25° / 35° / 60°

FOST TRACK 70

incl. DIM 355° 90° 50.000hs L70 / B10 MacAdam 2&3 220-240V 50 / 60Hz 650°C

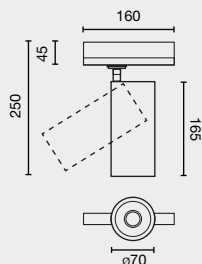

Family

Color T°

Beam Angle

Finish

Control System

0118 Fost Track ø70 43W

- 927** 2700K CRI90
- 930** 3000K CRI90
- 940** 4000K CRI90
- X27** 2700K CRI97
- X30** 3000K CRI97
- X40** 4000K CRI97

- 1** 18°
- 2** 23°
- 3** 36°
- 6** 60°

- 1** White
- 2** Black

- W** CASAMBI
- D** DALI
- ON/OFF**
- C** TRIAC

- MT** MEAT
- BR** BREAD
- FS** FASHION

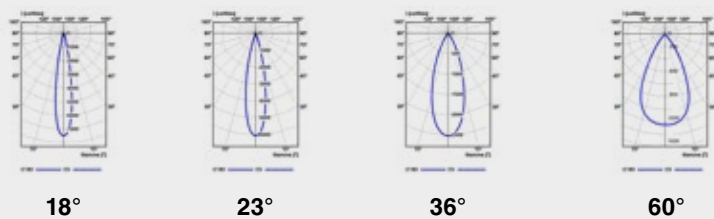

Option	Color T°	CRI	Power	Lumen Output	Beam Angle
927	2700K	90	43W	2954lm / 2931lm / 2920lm / 2800lm	18° / 23° / 36° / 60°
X27	2700K	97	43W	2658lm / 2638lm / 2628lm / 2520lm	18° / 23° / 36° / 60°
930	3000K	90	43W	3045lm / 3022lm / 3010lm / 2886lm	18° / 23° / 36° / 60°
X30	3000K	97	43W	2741lm / 2720lm / 2709lm / 2597lm	18° / 23° / 36° / 60°
940	4000K	90	43W	3136lm / 3113lm / 3100lm / 2972lm	18° / 23° / 36° / 60°
X40	4000K	97	43W	2823lm / 2801lm / 2790lm / 2675lm	18° / 23° / 36° / 60°
MT	-	-	43W	2165lm / 2149lm / 2140lm / 2052lm	18° / 23° / 36° / 60°
BR	-	-	43W	2921lm / 2899lm / 2888lm / 2769lm	18° / 23° / 36° / 60°
FS	-	-	43W	2998lm / 2976lm / 2964lm / 2842lm	18° / 23° / 36° / 60°





BLIT TRACK

BLIT TRACK is a versatile solution that provides flexibility and adaptability for various lighting applications. Designed to integrate into track lighting systems, it allows for precise light direction. Its elegant design enhances any environment and offers soft, ambient lighting that creates a cozy atmosphere.

BLIT TRACK es una solución versátil que proporciona flexibilidad y adaptabilidad para diversas aplicaciones de iluminación. Diseñado para integrarse en sistemas de iluminación en carril, permite dirigir la luz de manera precisa. Su diseño elegante realza cualquier entorno y ofrece una iluminación suave y ambiental que crea una atmósfera acogedora.



BLIT Collection



Surface
241

Blit 210mm
20W

Blit 300mm
33W

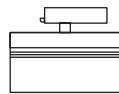

FINISH
Acabado

● **Black**
Negro

○ **White**
Blanco

COLOR TEMPERATURE
Temperatura de color

2700K CRI90

3000K CRI90

4000K CRI90

BEAM ANGLE
Ángulo de apertura

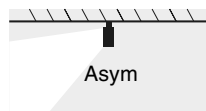

CONTROL SYSTEM
Sistema de control



CASAMBI

Highlights

Available in two power options and made entirely of aluminum and glass, BLIT TRACK provides general illumination through indirect light. Its minimalist design makes it perfect for complementing other track luminaires, such as projectors or linear lights, in environments like restaurants or commercial spaces.

Disponible en dos potencias, y fabricado íntegramente de aluminio y cristal, BLIT TRACK ofrece una iluminación general a través de luz indirecta. Su diseño minimalista lo hace perfecto para complementar otras luminarias de carril, como proyectores o luces lineales, en entornos como restaurantes o espacios comerciales.



High CRI
Alto IRC



High-quality materials
Materiales de alta calidad



Minimal design
Diseño minimalista

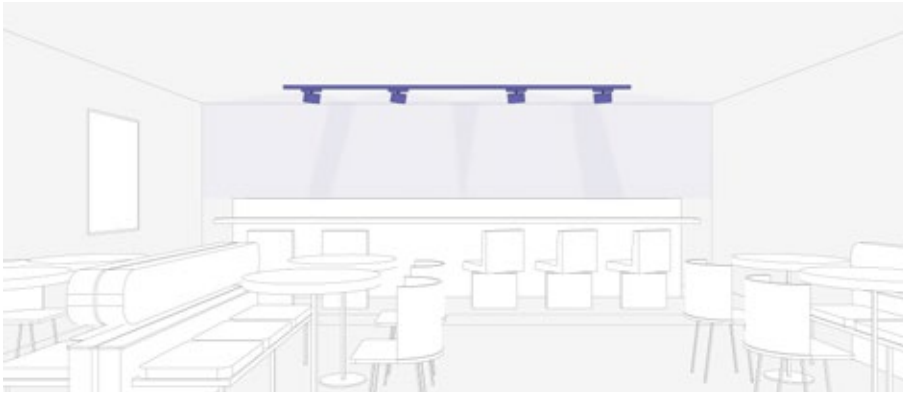

Restaurant

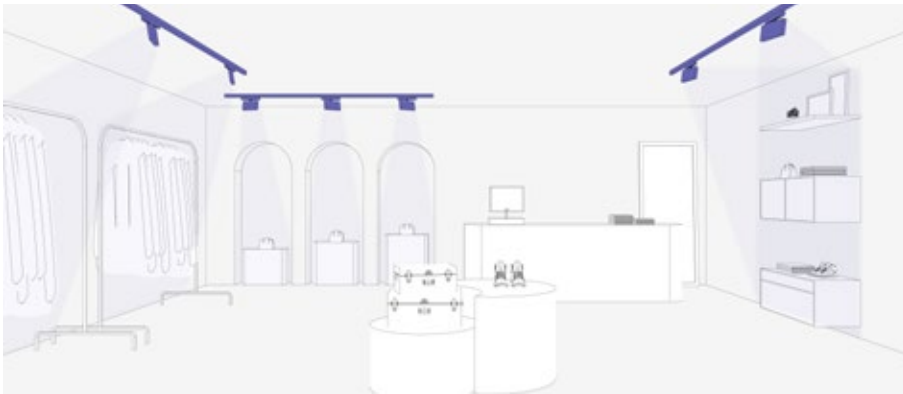

Retail

Beam Angle



Asym°

BLIT TRACK

NEW

incl. DIM 355° 30° 50.000hs L80 / B10 MacAdam 3 220-240V 50 / 60Hz 850°C

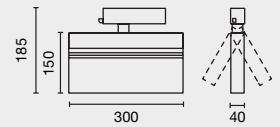
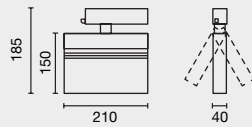

Family	Color T°	Beam Angle	Finish	Control System
0127 Blit track 210mm 20W	927 2700K CRI90	9 Asym	1 White	D DALI
0128 Blit track 300mm 33W	930 3000K CRI90		2 Black	W CASAMBI
	940 4000K CRI90			ON/OFF

0127 **927** **9** **1** **D**

Example **012792791D** — Blit track 210mm 20W 2700K CRI90 White Dali

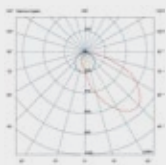

Asym

Option	Color T°	CRI	Power	Lumen Output	Beam Angle
927	2700K	90	20w	1633	Asym
		90	33w	3412	Asym
930	3000K	90	20w	1684	Asym
		90	33w	3517	Asym
940	4000K	90	20w	1734	Asym
		90	33w	3623	Asym



VIA EVO TRACK is a linear luminaire designed to seamlessly integrate into three-phase track systems. When combined with our other track luminaires, it becomes an efficient solution for providing general lighting in various spaces. It offers three different color temperatures and also comes in Tuneable White and UGR versions, allowing for lighting adjustment to meet specific needs.

VIA EVO TRACK es una luminaria lineal diseñada para adaptarse perfectamente a sistemas de carriles trifásicos. Cuando se combina con otras de nuestras luminarias de carril, se convierte en una solución eficiente para proporcionar iluminación general en espacios diversos. Ofrece tres temperaturas de color diferentes, además de contar con versiones Tuneable White y UGR, lo que permite ajustar la iluminación y satisfacer necesidades específicas.



VIA

TRACK





VIA Collection



System
369

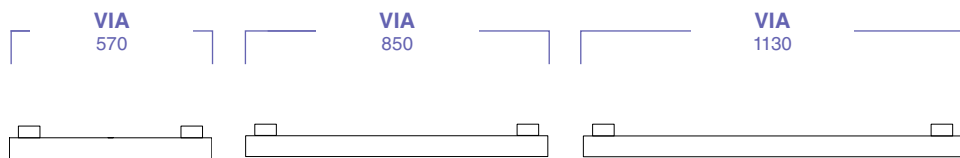

FINISH
Acabado

Black
Negro

White
Blanco

COLOR TEMPERATURE
Temperatura de color

3000K CRI80

4000K CRI80

2700-6500K

LEAF*

DIFFUSER
Difusor



Opal



Microprisma



UGR

CONTROL SYSTEM
Sistema de Control



CASAMBI

* Leaf. More information on page 31

* Leaf. Más información en la página 31

Highlights

Offering three different sizes and a variety of power options to adapt to the lighting needs of each space, VIA EVO TRACK is also available in UGR versions, ideal for office environments, and in TW versions, designed to provide circadian cycle lighting in specific spaces.

Ofreciendo tres tamaños diferentes y una variedad de potencias para adaptarse a las necesidades lumínicas de cada espacio, VIA EVO TRACK también está disponible en versiones UGR, ideales para entornos de oficina, y en versiones TW, diseñadas para proporcionar iluminación de ciclo circadiano en espacios específicos.



LEAF: Light source for plant growth.
LEAF: Fuente de luz para crecimiento de plantas.

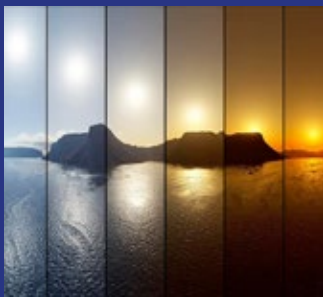

Tunable white



Different sizes
Diversos tamaños



Several color temperatures
Varias temperaturas de color

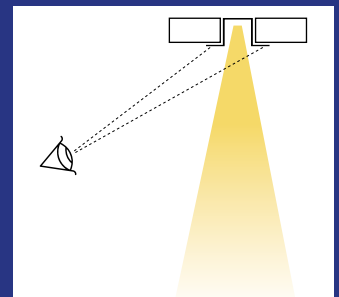

UGR<19

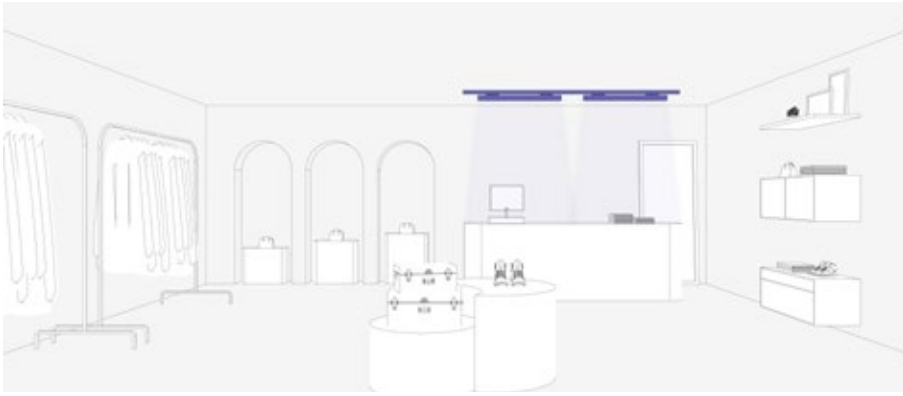

Retail



Office



Microprisma

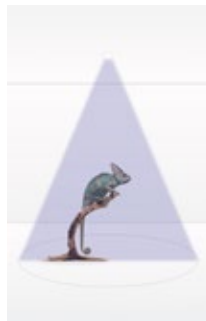

90°



Opal

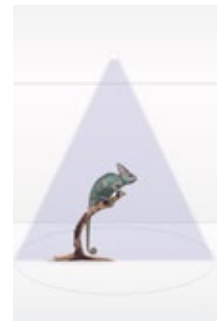

110°



UGR

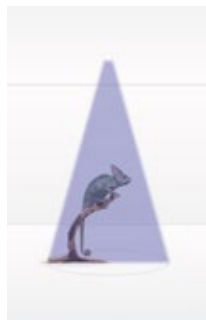

50°

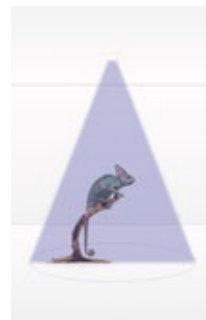

80°

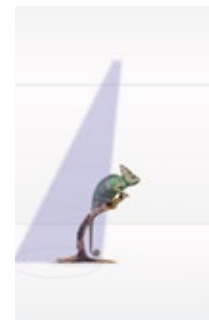

Asym°

VIA TRACK 570



incl. DIM 50.000hs L80/B10 MacAdam 3 TW 220-240V 50 / 60Hz 650°C

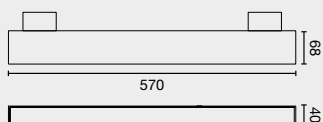

Family	Power	Finish	Control System	Diffuser
0410T Via Evo	590	Track 15W 3000K CRI80	<input type="checkbox"/> ON/OFF <input checked="" type="checkbox"/> W CASAMBI <input checked="" type="checkbox"/> D DALI	<input type="checkbox"/> Opal <input checked="" type="checkbox"/> U Microprisma
	570	Track 25W 3000K CRI80		
	680	Track 15W 4000K CRI80		
	660	Track 25W 4000K CRI80		
0410T Via Evo	010	Track 27W 2700-6500K TW	<input checked="" type="checkbox"/> W CASAMBI <input type="checkbox"/> DALI	<input type="checkbox"/> Opal <input checked="" type="checkbox"/> U Microprisma

0410T 570 1 W

Example **0410T5701W** — Via Evo Track 570 mm 25W 3000K Opal White

VIA TRACK 850



incl. DIM 50.000hs L80/B10 MacAdam 3 TW 220-240V 50 / 60Hz 650°C

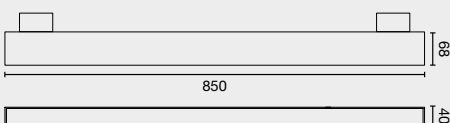

Family	Power	Finish	Control System	Diffuser
0410T Via Evo	560	Track 20W 3000K CRI80	<input type="checkbox"/> ON/OFF <input checked="" type="checkbox"/> W CASAMBI <input checked="" type="checkbox"/> D DALI	<input type="checkbox"/> Opal <input checked="" type="checkbox"/> U Microprisma
	540	Track 38W 3000K CRI80		
	650	Track 20W 4000K CRI80		
	630	Surface 38W 4000K CRI80		
0410T Via Evo	030	Track 39W 2700-6500K TW	<input checked="" type="checkbox"/> W CASAMBI <input type="checkbox"/> DALI	<input type="checkbox"/> Opal <input checked="" type="checkbox"/> U Microprisma

VIA TRACK 1130



- incl.
- DIM
- 50.000hs L80/B10
-
- MacAdam 3
- TW
- 220-240V
- 50 / 60Hz
- 650°C
- UGR 16

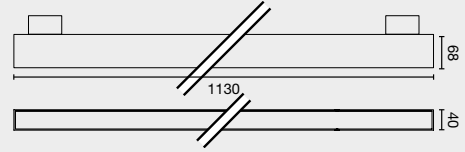

Family	Power	Finish	Control System	Diffuser
0410T Via Evo	530	Track 27W 3000K CRI80	ON/OFF	Opal
	510	Track 51W 3000K CRI80	W CASAMBI	U Microprisma
	620	Track 27W 4000K CRI80	D DALI	
	600	Track 51W 4000K CRI80		
	N LF	Track Leaf 33W		
0410T Via Evo	050	Track 48W 2700-6500K TW	W CASAMBI	Opal
			D DALI	U Microprisma
0410T Via Evo	110	Track UGR 32W 3000K CRI80	ON/OFF	8 UGR<19 80°
	120	Track UGR 32W 4000K CRI80	W CASAMBI	5 UGR<16 50°
	111	Track UGR 17W 3000K CRI80	D DALI	0 UGR<19 asim.
	121	Track UGR 17W 4000K CRI80		
0410T Via Evo	010	Track UGR 54W 2700-6500K TW	W CASAMBI	8 UGR<19 80°
			D DALI	5 UGR<16 50°
				0 UGR<19 asim.

VIA TRACK

570mm

Option	Color T°	CRI	Difusor	Power	Lumen Output	Beam Angle
590	3000K	80	Opal / Microprisma	15W	1392lm / 1133lm	110° / 90°
570		80	Opal / Microprisma	25W	2506m / 2039m	110° / 90°
680	4000K	80	Opal / Microprisma	15W	1434lm / 1167lm	110° / 90°
660		80	Opal / Microprisma	25W	2581lm / 2100lm	110° / 90°
010	2700-6500K	TW	Opal / Microprisma	27W	1964lm / 1598lm	110° / 90°

850mm

560	3000K	80	Opal / Microprisma	20W	2131lm / 1735lm	110° / 90°
540		80	Opal / Microprisma	38W	3809lm / 3121lm	110° / 90°
650	4000K	80	Opal / Microprisma	20W	2195lm / 1787lm	110° / 90°
630		80	Opal / Microprisma	39W	3923lm / 3214lm	110° / 90°
010	2700-6500K	TW	Opal / Microprisma	39W	2985lm / 2429lm	110° / 90°

1130mm

530	3000K	80	Opal / Microprisma	27W	2842lm / 2313lm	110° / 90°
510		80	Opal / Microprisma	51W	5112lm / 4161lm	110° / 90°
620	4000K	80	Opal / Microprisma	27W	2927lm / 2382lm	110° / 90°
600		80	Opal / Microprisma	51W	5265lm / 4286lm	110° / 90°
050	2700-6500K	TW	Opal / Microprisma	48W	4006lm / 3261lm	110° / 90°
110	3000K	80	UGR<16 / UGR<19	32W	3989lm / 4104lm / 3739lm	50° / 80° / Asym
120	4000K	80	UGR<16 / UGR<19	32W	4109lm / 4227lm / 3851lm	50° / 80° / Asym
010	2700-6500K	TW	UGR<16 / UGR<19	54W	4830lm / 4881lm / 4467lm	50° / 80° / Asym



How to install

CÓMO INSTALARLO

3Phase track, 16 A

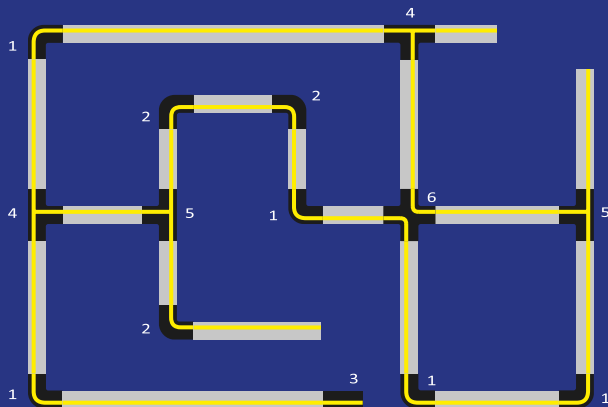

1 Outer "L" joint



2 Inner "L" joint



3 Outer live end



4 Outer "T"



5 Inner "T"



6 Cross joint

Connection sketch Esquema de conexiones

1 Circuit

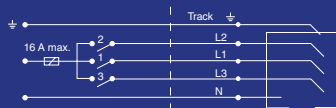

N-conductor $i = 16$ A max

2 Circuit

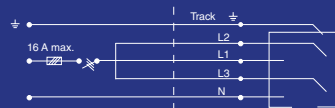

N-conductor $i = 16$ A max

3 Circuit

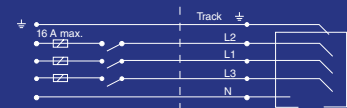

$L1 + L2 + L3$ $i = 16$ A max

Recommended distance between fixing Distancia recomendada entre fijaciones

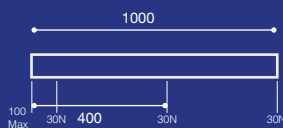

Max.Weight: 19,84 lb
Peso máx.: 9 kg

Max. 3 projectors = 3,8 KVA
Máx. 3 proyectores = 3,8 KVA

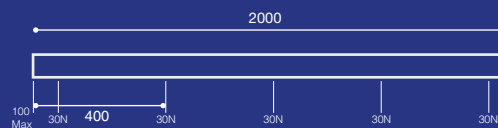

Max.Weight: 33,06 lb
Peso máx.: 15 kg

Max. 5 projectors = 3,8 KVA
Máx. 5 proyectores = 3,8 KVA

3Phase Track

Compatible with IVELA & GLOBAL



Surface & Suspended 3 phase track

01990101	● White	1000 mm
01990102	● Black	1000 mm
01990201	● White	2000 mm
01990202	● Black	2000 mm

Inner live end

	01990601	● White
	01990602	● Black

Outer live end

	01990701	● White
	01990702	● Black

Centre feed

	01993301	● White
	01993302	● Black

Inner "L" Joint

	01990501	● White
	01990502	● Black

Outer "L" Joint

	01990401	● White
	01990402	● Black

Outer "T"

	01990901	● White
	01990902	● Black

Inner "T"

	01991601	● White
	01991602	● Black

Ceiling kit 1 piece

	01991201	● Aluminium
-------------------------------------------------------------------------------------	----------	-------------

Cross Joint

	01991001	● White
	01991002	● Black

Intermediate Joint

	01990801	● White
	01990802	● Black

End cap

	01991101	● White
	01991102	● Black

Flexible "L"

	01993201	● White
	01993202	● Black

Pendant Kit 2000

	01990301	● White
	01990302	● Black

Base for surface

	01991301	● White
	01991302	● Black

Adapter / track connector

	01997001	● White
	01997002	● Black



Surface & Suspended Dali track

01990101D	● White	1000 mm
01990102D	● Black	1000 mm
01990201D	● White	2000 mm
01990202D	● Black	2000 mm

Dali inner live end

	01993501D	● White
	01993502D	● Black

Dali outer live end

	01993601D	● White
	01993602D	● Black

Dali centre feed

	01993301D	● White
	01993302D	● Black

Inner "L" Joint

	01990501D	● White
	01990502D	● Black

Outer "L" Joint

	01990401D	● White
	01990402D	● Black

Ceiling kit 1 piece

	01991201D	● White
	01991202D	● Black

Intermediate Joint

	01990801D	● White
	01990802D	● Black

End cap

	01991101D	● White
	01991102D	● Black

Flexible "L"

	01993201D	● White
	01993202D	● Black

Pendant Kit 5000

	01990301D	● White
	01990302D	● Black

Base for surface

	01991301D	● White
	01991302D	● Black

Adapter / track connector

	01997001D	● White
	01997002D	● Black



Recessed 3 phase track

01997101	● White	1000 mm
01997102	● Black	1000 mm
01997201	● White	2000 mm
01997202	● Black	2000 mm

Inner live end

	01997401	● White
	01997402	● Black

Outer live end

	01997301	● White
	01997302	● Black

Centre feed

	01997801	● White
	01997802	● Black

Intermediate Joint

	01997501	● White
	01997502	● Black

End cap

	01997701	● White
	01997702	● Black

Ceiling Kit 1piece

	01997601	● Aluminium
-------------------------------------------------------------------------------------	----------	-------------

Adapter / track connector

	01997001	● White
	01997002	● Black





D O W N L I G H T S

The KOPE downlight is the perfect solution for spaces with sloped ceilings or where precise light orientation is required. Its minimalist design makes it ideal for discreet integration into any environment. This versatile and compact downlight can be tilted and recessed according to lighting needs, providing complete control over the direction of light and adding functionality and elegance to any space.

El downlight KOPE es la solución perfecta para espacios con techos inclinados o donde se requiere una orientación precisa de la luz. Su diseño minimalista lo hace ideal para integrarse discretamente en cualquier entorno. Este downlight versátil y de dimensiones reducidas se puede inclinar y retraer según las necesidades de iluminación, brindando un control total sobre la dirección de la luz y dotando de funcionalidad y elegancia cualquier tipo de espacio.





KOPE



Kope 7W

Kope 13W

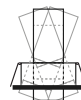
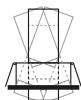

ø85

ø100

FINISH
Acabado

● **Black**
Negro

○ **White**
Blanco

COLOR TEMPERATURE
Temperatura de color

2700K CRI90

3000K CRI90

4000K CRI90

BEAM ANGLE
Ángulo de apertura

20°

36°

CONTROL SYSTEM
Sistema de control



CASAMBI

Highlights



With two sizes and powers, Kope stands out for its ability to be adjustable, as well as for its “up-down” movement. Ideal for sloped ceilings where the light beam is to be kept vertical, or for light points where an adjustable or directional beam is desired.

Con dos tamaños y potencias, Kope destaca por la posibilidad de ser orientable, así como del movimiento “up down”. Ideal para techos inclinados en los que lo que se quiera mantener el haz de luz en vertical, o para puntos de luz donde se busque un haz inclinable u orientable.



Consider the installation height in your project

Tenga en cuenta la altura de la instalación en su proyecto



High CRI Alto IRC



Several color temperatures Varias temperaturas de color



Possibility orientation, up down

Posibilidad orientación, subir y bajar



Restaurant



Home

Beam Angle



20°



36°

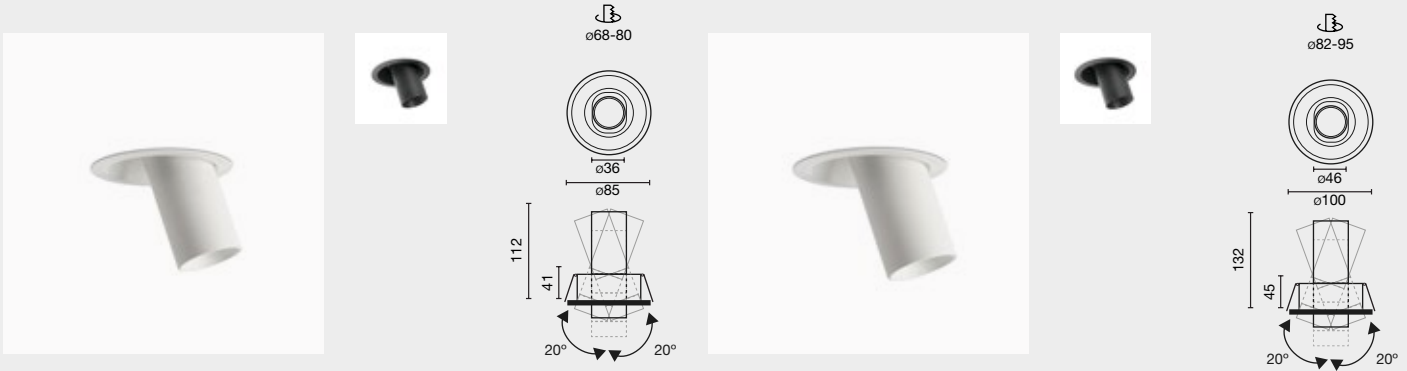

Family	Color T°	Beam Angle	Finish	Control System
0225 Kope 7W	927 2700K CRI90	2 20°	1 White	W CASAMBI
0226 Kope 13W	930 3000K CRI90	4 36°	2 Black	D DALI
	940 4000K CRI90			ON/OFF

0354 927 6 1 W

Example 0022592721W — Kope 7W 2700K CRI90 20° White Casambi

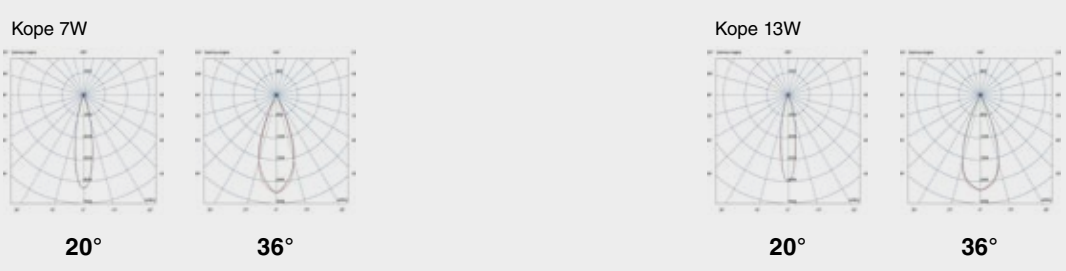

Option	Color T°	CRI	Power	Lumen Output	Beam Angle
927	2700K	90	7w	451/494	20°/36°
		90	13w	859/818	20°/36°
930	3000K	90	7w	465/495	20°/36°
		90	13w	886/837	20°/36°
940	4000K	90	7w	479/524	20°/36°
		90	13w	913/868	20°/36°





KOBO

The KOBO downlight is a robust and reliable solution, with an IP67 rating, making it ideal for applications in hospitals and industries where resistance and durability are crucial. With two available beam angles, it can adapt to a wide range of lighting needs, from general illumination to specific tasks. Its solid design and features ensure high performance in demanding environments where light quality is essential.

El downlight KOBO es una solución robusta y confiable, con clasificación IP67 que lo hace ideal para aplicaciones en hospitales e industrias donde la resistencia y la durabilidad son fundamentales. Con dos ángulos de apertura disponibles, se adapta a un sinfín de necesidades de iluminación, desde iluminación general hasta tareas específicas. Su diseño sólido y sus prestaciones garantizan un alto rendimiento en entornos exigentes donde la calidad de la luz es esencial.



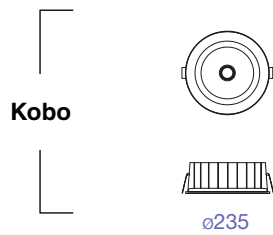

Kobo

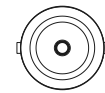

ø235

FINISH
Acabado

White
Blanco

COLOR TEMPERATURE
Temperatura de color

2700K CRI90

3000K CRI90

4000K CRI90

2700-6500K

BEAM ANGLE
Ángulo de apertura



60°

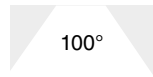

100°

CONTROL SYSTEM
Sistema de control



CASAMBI

Highlights

With two options for beam angles, a UGR below 16, and an IP67 protection rating, this downlight becomes the ideal choice for hospital environments. The Tunable White version provides the flexibility to offer circadian cycle lighting.

Con dos opciones de ángulos de apertura, un UGR inferior a 16 y un grado de protección IP67, este downlight se convierte en la opción ideal para entornos hospitalarios. La versión de Tunable White proporciona la flexibilidad de ofrecer iluminación de ciclo circadiano.



IP65
IP65



High CRI
Alto IRC

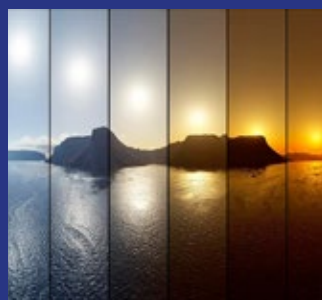

Tunable white

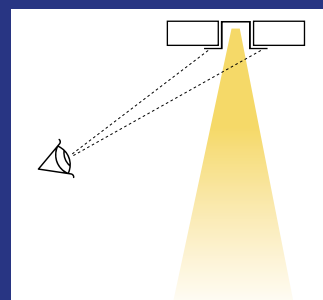

UGR<19



Hospital

Beam Angle



60°

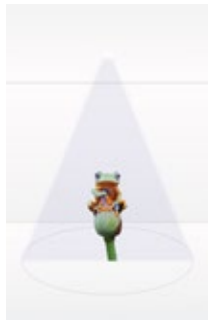

100°



60°



100°

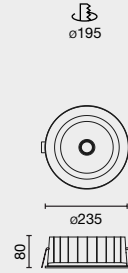

Family	Color T°	Beam Angle	Finish	Control System
0354 Kobo 27W	927 2700K CRI90	6 60°	1 White	W CASAMBI
	930 3000K CRI90	9 100°		D DALI
	940 4000K CRI90			ON/OFF
0354 Kobo 28W	TW 2700-6500K	9 100°	1 White	W CASAMBI D DALI
0354	927	6	1	W

Example 035492761W — Kobo 27W 2700K CRI90 60° White Casambi

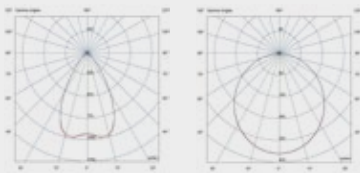

60°

100°

Option	Color T°	CRI	Power	Lumen Output	Beam Angle
927	2700K	90	15W	1506/1661lm	60° / 100°
			27W	2394/2640lm	
930	3000K	90	15W	1551/1711lm	60° / 100°
			27W	2468/2722lm	
940	4000K	90	15W	1598/1762lm	60° / 100°
			27W	2542/2804lm	
TW	2000-6000K	90	27W	1672lm	100°



DEEP is a series of recessed light fixtures available in 3 sizes (S, M, L), two formats (round or square) and with or without frame. Its wide range of colour temperature, different optics and CRI options makes it a perfect option for commercial spaces, hotels, restaurants and retail. Its accessories enable better glare control and maximum visual comfort.



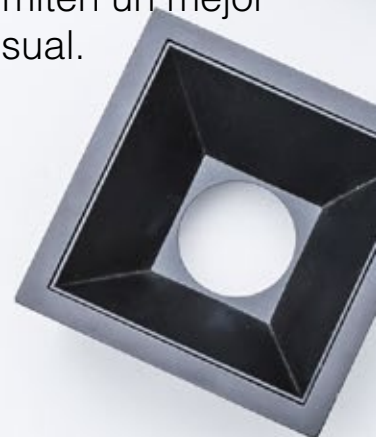





DEEP es una serie de luminarias empotradas disponible en 3 tamaños (S, M, L), dos formatos (redondo o cuadrado), y opción con marco y sin marco. Su amplia gama de temperatura de color, diversas ópticas y opciones de IRC la convierten en una opción perfecta para espacios comerciales, hoteles, restauración y retail. Sus accesorios permiten un mejor control del deslumbramiento, así como maximizar el confort visual.



DEEP



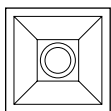
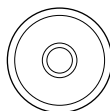
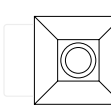
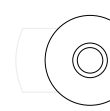

	TRIM Con marco		TRIMLESS Sin marco	
S 6 / 11W	 95x95	 ø93	 85x85	 ø83
M 12 / 18W	 115x115	 ø115	 103x103	 ø103
L 18 / 25 / 39W	 135x135	 ø135	 123x123	 ø123

FINISH
Acabado

● **Black**
Negro

○ **White**
Blanco

COLOR TEMPERATURE
Temperatura de color

2700K CRI90

3000K CRI90

4000K CRI90

FASHION

BEAM ANGLE
Ángulo de apertura

15°

36°

60°

ACCESSORIES
Accesorios



Honeycomb



Striped glass



Spread Glass

CONTROL SYSTEM
Sistema de control



CASAMBI



Highlights

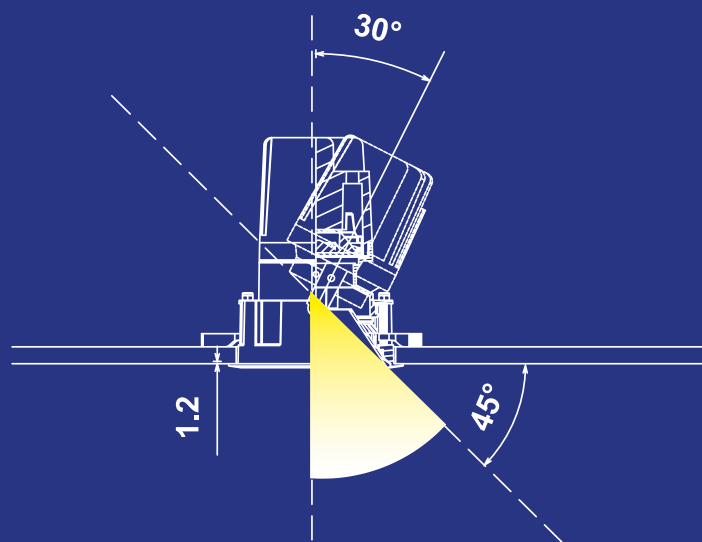

Different sizes
Diversos tamaños



High-quality materials
Materiales de alta calidad



Adjustable
Orientable



Several color temperatures
Varias temperaturas de color

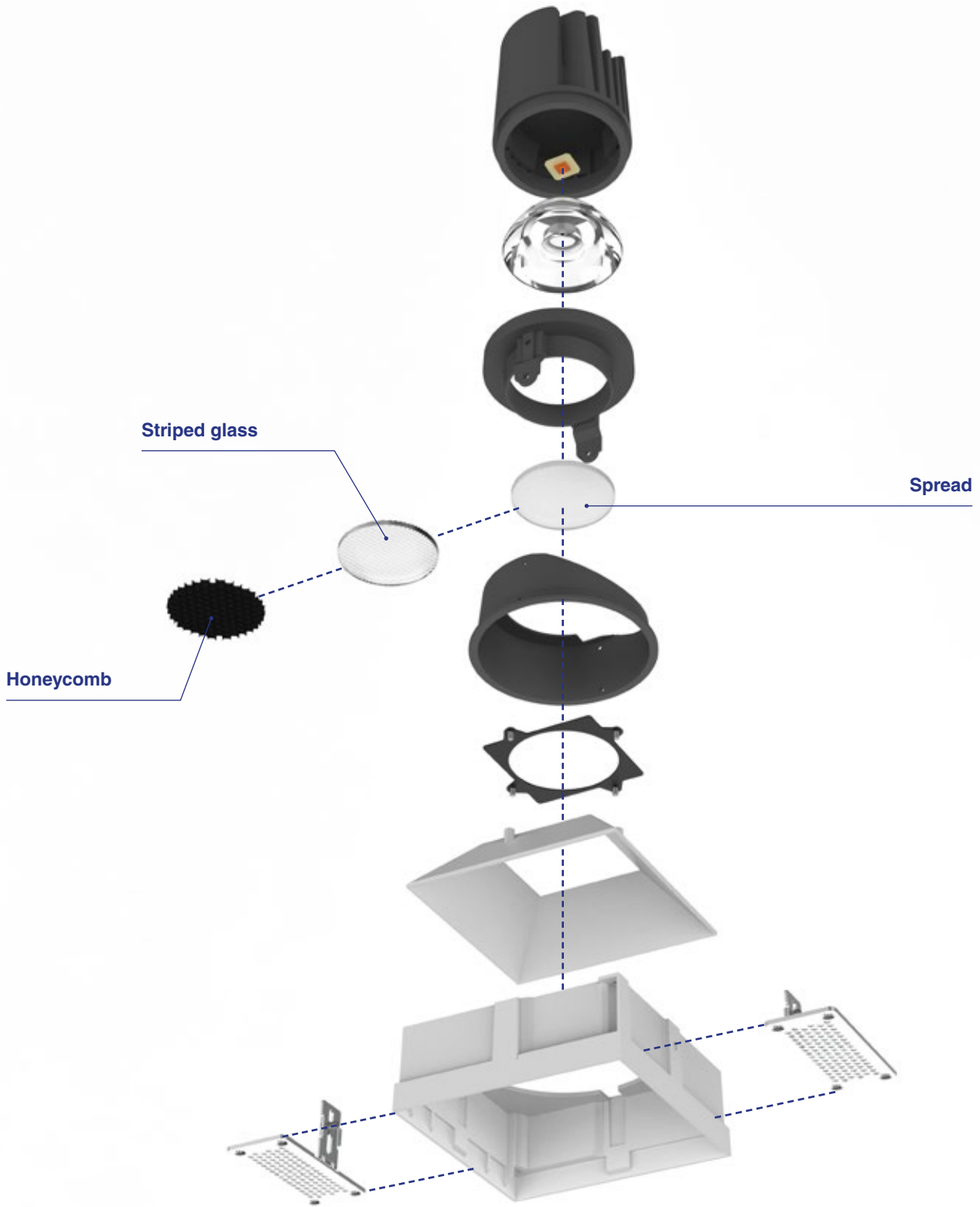



Honeycomb



Striped glass



Spread



Without accessory



Spread Glass



Striped Glass



Office



Restaurant

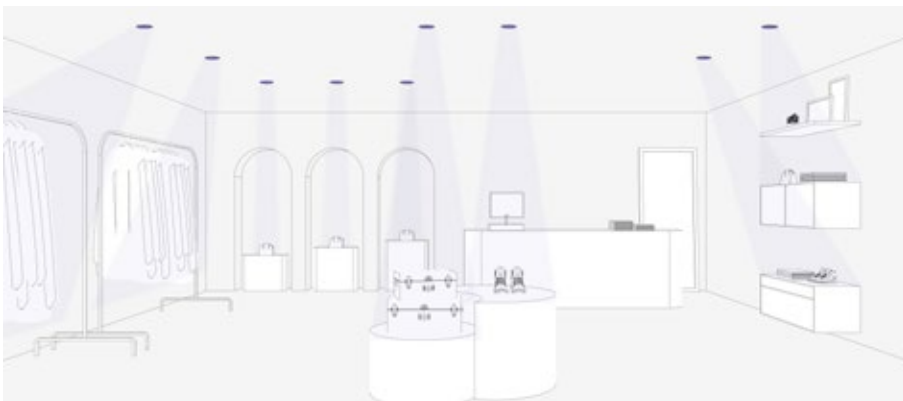

Retail

Beam Angle



15°



36°

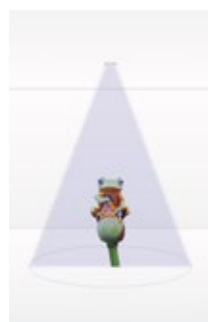

60°

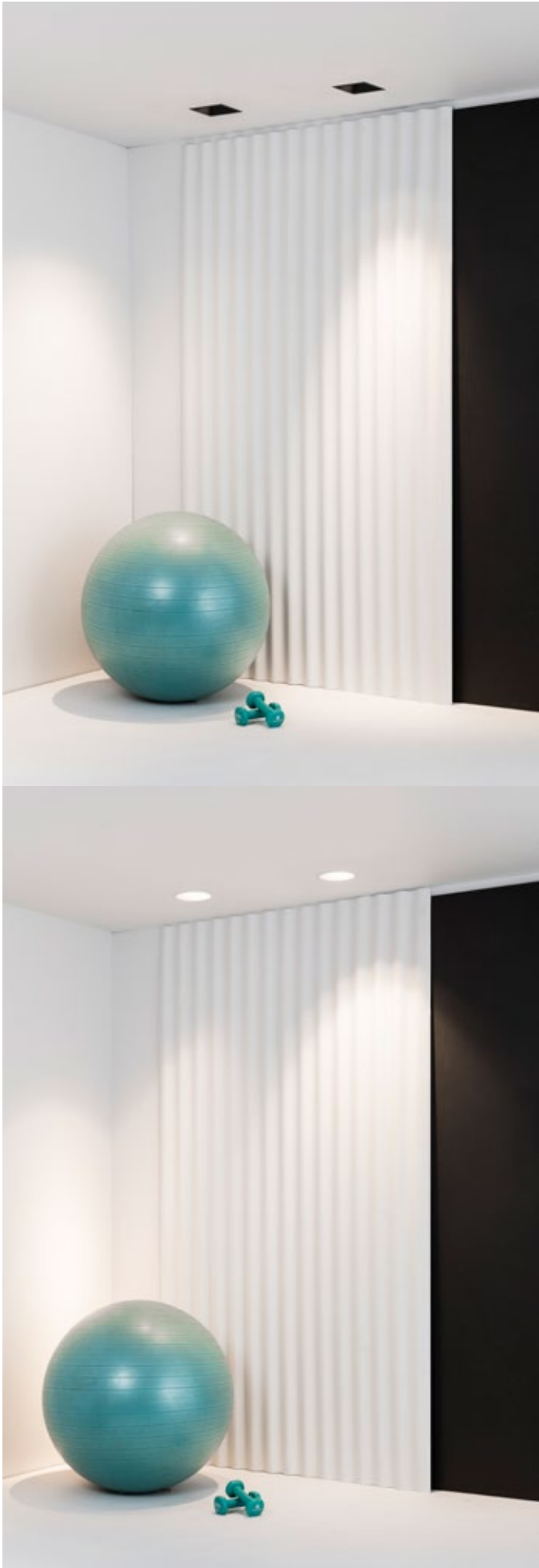



Need consulting
for your project?
¿Necesitas
asesoramiento
para tu proyecto?



DEEP S Round

no incl. DIM 355° 30° 50.000hs L90 / B10 MacAdam 2 IP23 6W 11W 200mA 29V 350mA 30V 650°C

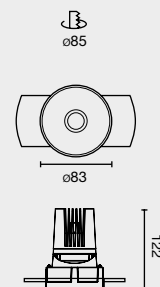
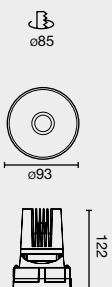

Family	Color T°	Beam Angle	Finish	Accessory
30135 Deep S Round	927 2700K CRI90	1 15°	1 White	No accessory
30235 Deep S Round Trimless	930 3000K CRI90	3 36°	2 Black	H Honeycomb
	940 4000K CRI90	6 60°		S Striped glass
				D Spread

30135 **827** **1** **1** **H**

Example **3013582711H** — Deep 60 Round 2700K 15° White Honeycomb

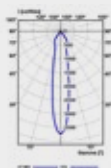

15°

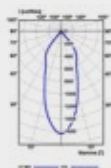

36°

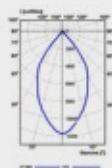

60°

lm

Option	Color T°	CRI	Power	Lumen Output	Beam Angle
927	2700K	90	6W	291 / 352 / 287lm	15° / 30° / 40°
			11W	466 / 339 / 452lm	15° / 30° / 40°
930	3000K	90	6W	301 / 363 / 296lm	15° / 30° / 40°
			11W	481 / 350 / 467lm	15° / 30° / 40°
940	4000K	90	6W	310 / 471 / 384lm	15° / 30° / 40°
			11W	495 / 360 / 481lm	15° / 30° / 40°

Driver not included. See recommended drivers on page 428-429
Driver no incluido. Ver drivers recomendados en página 428-429

DEEP S Square

no incl. DIM 355° 30° 50.000hs L90 / B10 MacAdam 2 IP23 6W 200mA 29V 11W 350mA 30V 650°C

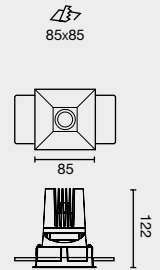
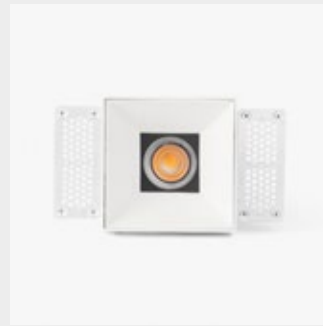
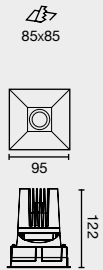

Family	Color T°	Beam Angle	Finish	Accessory
30335 Deep S Square	927 2700K CRI90	1 15°	1 White	No accessory
30435 Deep S Square Trimless	930 3000K CRI90	3 36°	2 Black	H Honeycomb
	940 4000K CRI90	6 60°		S Striped glass
				D Spread

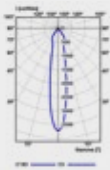

15°

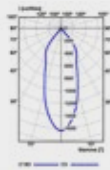

36°



60°

Option	Color T°	CRI	Power	Lumen Output	Beam Angle
927	2700K	90	6W	291 / 352 / 287lm	15° / 30° / 40°
			11W	466 / 339 / 452lm	15° / 30° / 40°
930	3000K	90	6W	301 / 363 / 296lm	15° / 30° / 40°
			11W	481 / 350 / 467lm	15° / 30° / 40°
940	4000K	90	6W	310 / 471 / 384lm	15° / 30° / 40°
			11W	495 / 360 / 481lm	15° / 30° / 40°

Driver not included. See recommended drivers on page 428-429
Driver no incluido. Ver drivers recomendados en página 428-429

DEEP M Round

no incl. DIM 355° 30° 50.000hs L90 / B10 MacAdam 2 IP23 12W 350mA 34V 18W 500mA 36V 650°C

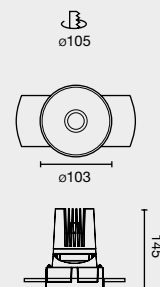

Family

Color T°

Beam Angle

Finish

Accessory

30550	Deep M Round
30650	Deep M Round Trimless

927	2700K CRI90
930	3000K CRI90
940	4000K CRI90

1	15°
3	36°
6	60°

1	White
2	Black

	No accessory
	H Honeycomb
	S Striped glass
	D Spread

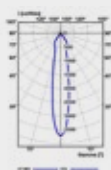

15°

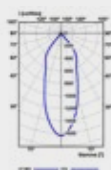

36°



60°

Option	Color T°	CRI	Power	Lumen Output	Beam Angle
927	2700K	90	12W	1067 / 920 / 764lm	15° / 36° / 50°
			18W	1217 / 1290 / 1040lm	15° / 36° / 50°
930	3000K	90	12W	110 / 949 / 788lm	15° / 36° / 50°
			18W	1255 / 1330 / 1073lm	15° / 36° / 50°
940	4000K	90	12W	1133 / 977 / 811lm	15° / 36° / 50°
			18W	1292 / 1369 / 1105lm	15° / 36° / 50°

Driver not included. See recommended drivers on page 428-429
Driver no incluido. Ver drivers recomendados en página 428-429

DEEP M Square

no incl. DIM 355° 30° 50.000hs L90 / B10 MacAdam 2 IP23 12W 350mA 34V 18W 500mA 36V 650°C



105x105

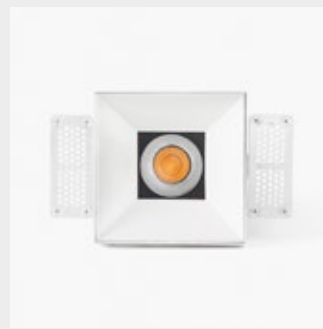

105x105

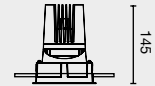
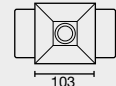

Family	Color T°	Beam Angle	Finish	Accessory
30750 Deep M Square	927 2700K CRI90	1 15°	1 White	No accessory
30850 Deep M Square Trimless	930 3000K CRI90	3 36°	2 Black	H Honeycomb
	940 4000K CRI90	6 60°		S Striped glass
				D Spread

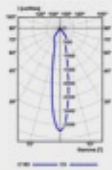

15°

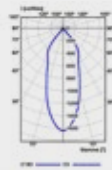

36°



60°

Option	Color T°	CRI	Power	Lumen Output	Beam Angle
927	2700K	90	12W	1067 / 920 / 764lm	15° / 36° / 50°
			18W	1217 / 1290 / 1040lm	15° / 36° / 50°
930	3000K	90	12W	110 / 949 / 788lm	15° / 36° / 50°
			18W	1255 / 1330 / 1073lm	15° / 36° / 50°
940	4000K	90	12W	1133 / 977 / 811lm	15° / 36° / 50°
			18W	1292 / 1369 / 1105lm	15° / 36° / 50°

Driver not included. See recommended drivers on page 428-429
Driver no incluido. Ver drivers recomendados en página 428-429

DEEP L Round

no incl. DIM 355° 30° 50.000hs L90 / B10 MacAdam 2 IP23 18W 500mA 34V 25W 700mA 35V 39W 1050mA 37V 650°C

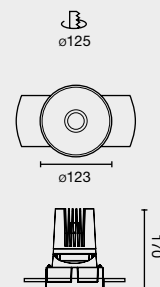

Family	Color T°	Beam Angle	Finish	Accessory
30910 Deep L Round	927 2700K CRI90	1 15°	1 White	No accessory
31010 Deep L Round Trimless	930 3000K CRI90	3 36°	2 Black	H Honeycomb
	940 4000K CRI90	6 60°		S Striped glass
	941 Fashion CRI95			D Spread

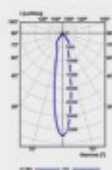

15°

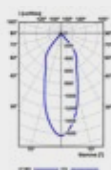

36°



60°

Option	Color T°	CRI	Power	Lumen Output	Beam Angle
927	2700K	90	18W	1420 / 1487 / 1248lm	15° / 36° / 60°
			25W	1923 / 1990 / 1668lm	15° / 36° / 60°
			39W	2551 / 2845 / 2361lm	15° / 36° / 60°
930	3000K	90	18W	1464 / 1534 / 1287lm	15° / 36° / 60°
			25W	1983 / 2052 / 1720lm	15° / 36° / 60°
			39W	2630 / 2934 / 2435lm	15° / 36° / 60°
940	4000K	90	18W	1507 / 1580 / 1325lm	15° / 36° / 60°
			25W	2042 / 2113 / 1771lm	15° / 36° / 60°
			39W	2708 / 3022 / 2508lm	15° / 36° / 60°

Driver not included. See recommended drivers on page 428-429
Driver no incluido. Ver drivers recomendados en página 428-429

DEEP L Square

no incl. DIM 355° 30° 50.000hs L90 / B10 MacAdam 2 IP23 18W 500mA 34V 25W 700mA 35V 39W 1050mA 37V 650°C



125x125

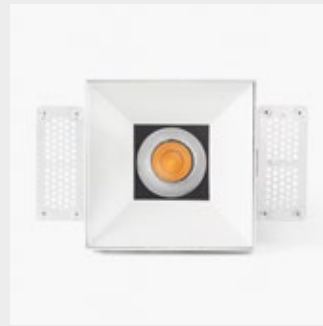

125x125

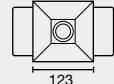

Family	Color T°	Beam Angle	Finish	Accessory
31110 Deep L Square	927 2700K CRI90	1 15°	1 White	No accessory
31210 Deep L Square Trimless	930 3000K CRI90	3 36°	2 Black	H Honeycomb
	940 4000K CRI90	6 60°		S Striped glass
	941 Fashion CRI95			D Spread

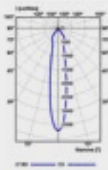

15°

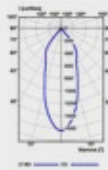

36°



60°

Option	Color T°	CRI	Power	Lumen Output	Beam Angle
927	2700K	90	18W	1420 / 1487 / 1248lm	15° / 36° / 60°
			25W	1923 / 1990 / 1668lm	15° / 36° / 60°
			39W	2551 / 2845 / 2361lm	15° / 36° / 60°
930	3000K	90	18W	1464 / 1534 / 1287lm	15° / 36° / 60°
			25W	1983 / 2052 / 1720lm	15° / 36° / 60°
			39W	2630 / 2934 / 2435lm	15° / 36° / 60°
940	4000K	90	18W	1507 / 1580 / 1325lm	15° / 36° / 60°
			25W	2042 / 2113 / 1771lm	15° / 36° / 60°
			39W	2708 / 3022 / 2508lm	15° / 36° / 60°

Driver not included. See recommended drivers on page 428-429
 Driver no incluido. Ver drivers recomendados en página 428-429

A collection of downlights with infinite options of sizes, formats, finishes and light angles. All this and much more in the palm of your hand.

Una colección de downlights con infinitas opciones de tamaños, formatos, acabados y ángulos de apertura. Todo esto y mucho más en la palma de tu mano.



TROOP

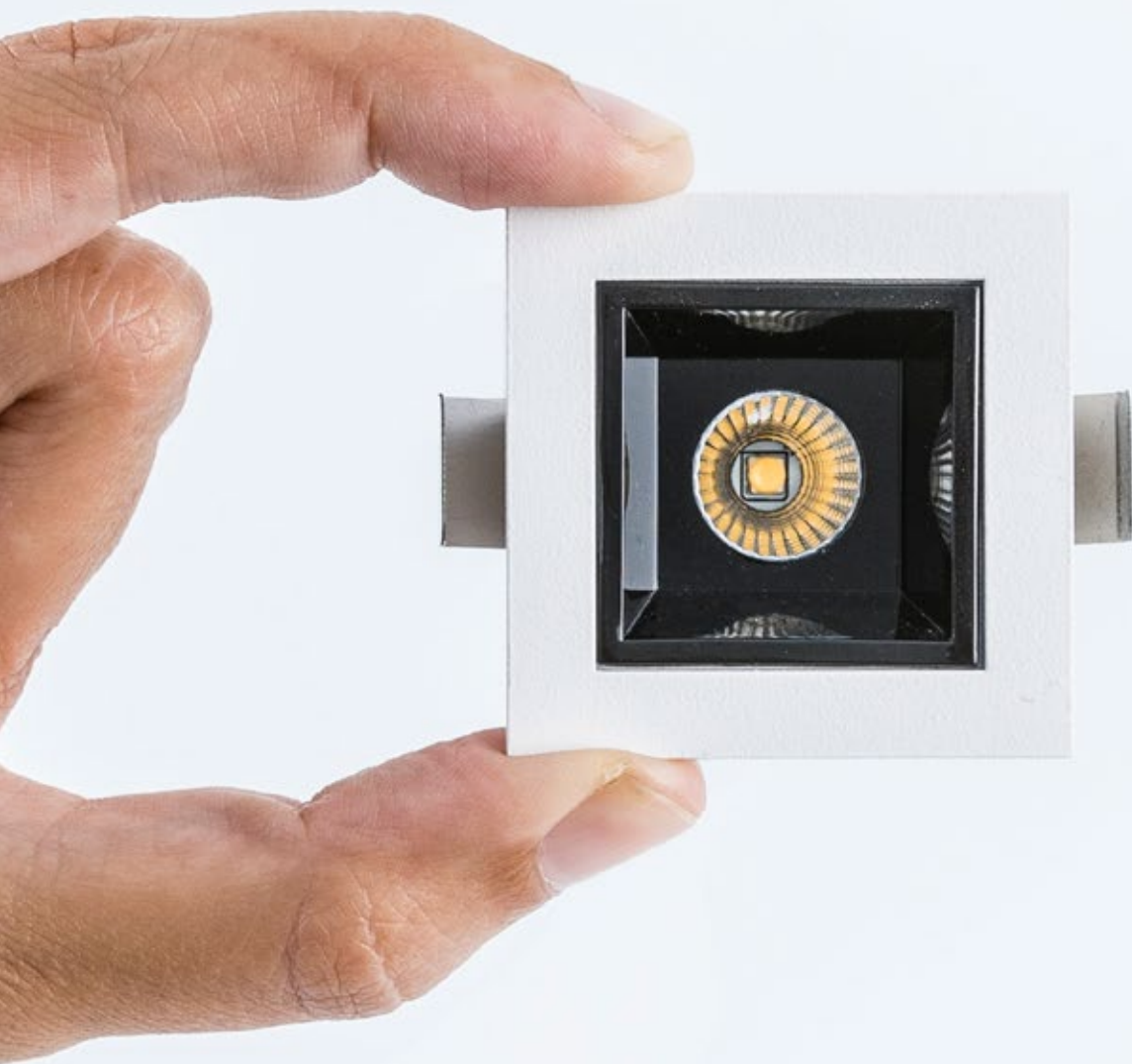



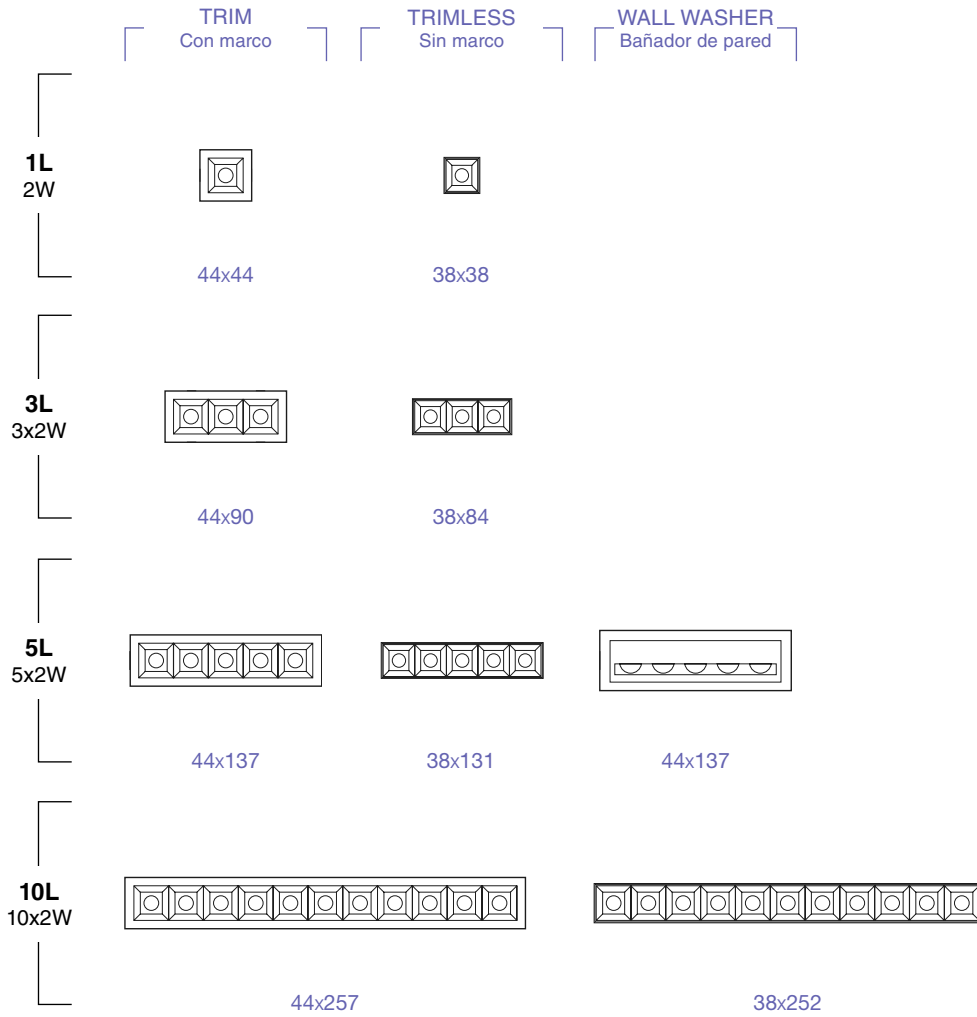

FINISH
Acabado

- Black+Black**
Negro+Negro
- Black+White**
Negro+Blanco
- White+White**
Blanco+Blanco
- White+Black**
Blanco+Negro
- Black+Gold**
Negro+Oro
- White+Gold**
Blanco+Oro

COLOR TEMPERATURE
Temperatura de color

- 2700K CRI90
- 3000K CRI90
- 4000K CRI90

BEAM ANGLE
Ángulo de apertura

- 15°
- 36°
- 48°

CONTROL SYSTEM
Sistema de control



Highlights

Anti-glare optics
Óptica antideslumbrante

UGR

Reflector with dark light technology
Reflector con tecnología dark light

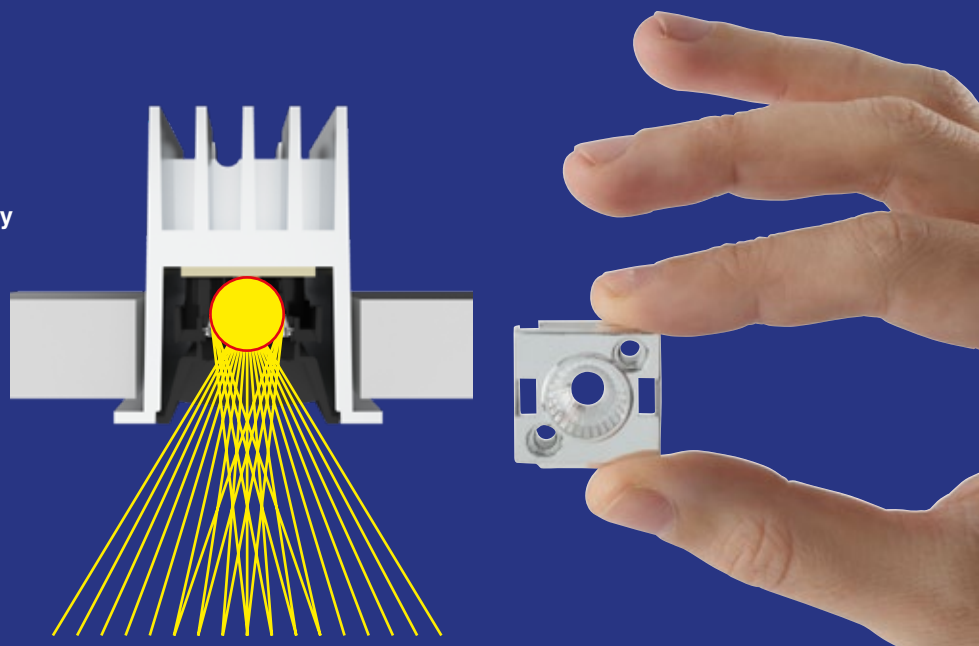

Different sizes & finishes
Diversos tamaños y acabados



Linear design with circular light effect
Diseño lineal con efecto lumínico circular



Wall washer version
Versión bañador de pared



Several color temperatures
Varias temperaturas de color



Residential



Restaurant

Beam Angle

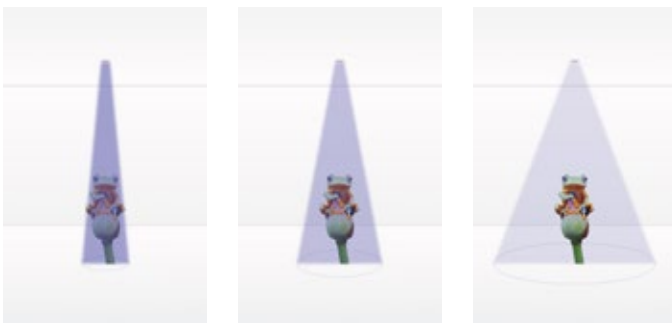

15°

36°

48°



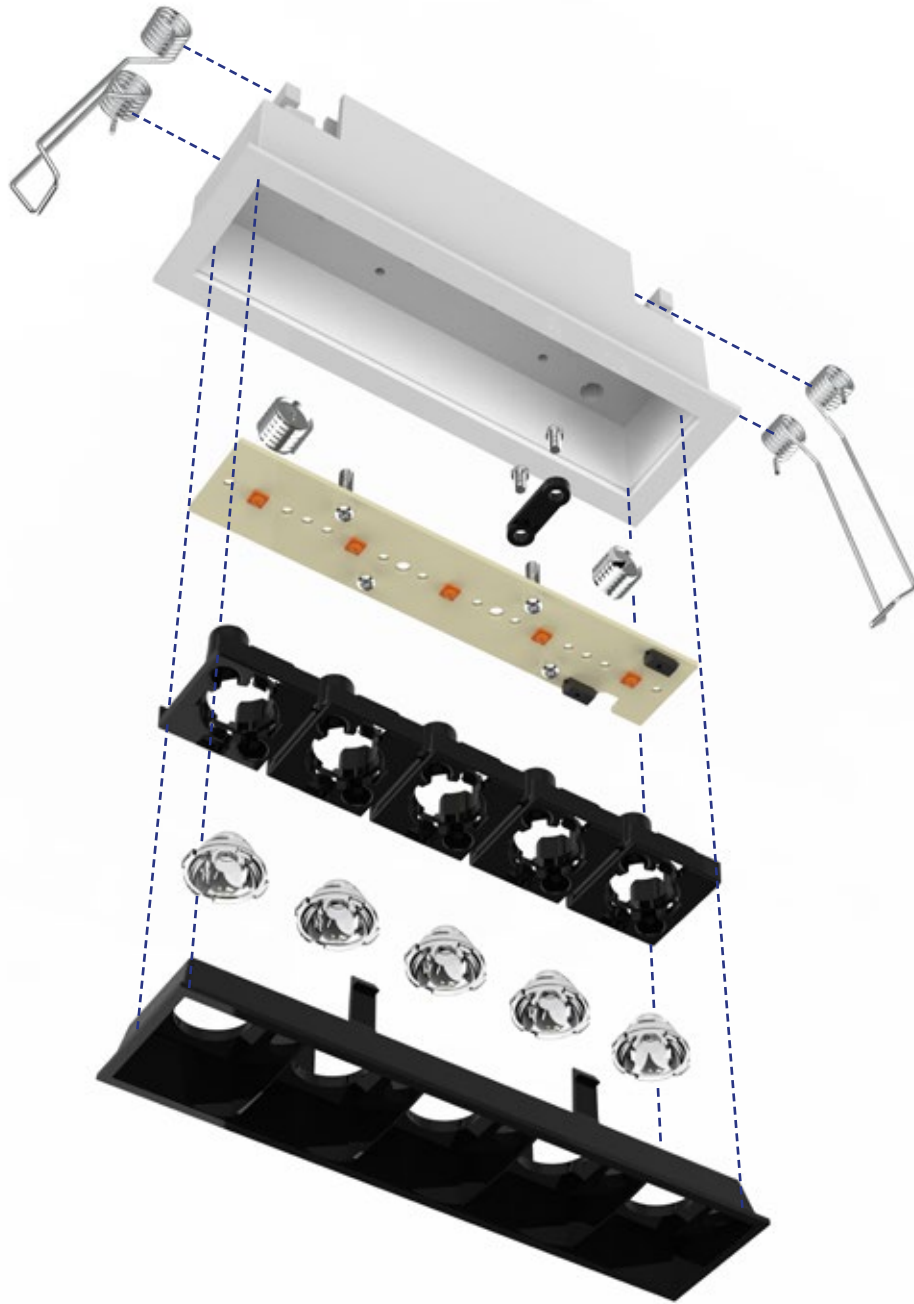

TROOP 1L

no incl. DIM 50.000hs L70 / B10 MacAdam 3 700mA 2.85V 650°C UGR <16



Family	Color T°	Beam Angle	Trim	Anti-Glare
43700 Troop Trim 2W	927 2700K CRI90	1 15°	0 Trimless	1 White
43704 Troop Trimless 2W	930 3000K CRI90	3 36°	1 White	2 Black
	940 4000K CRI90	4 48°	2 Black	4 Gold

43700 **927** **1** **1** **1**

Example **43700927111** — Troop Trim 2W 2700K 15° White White

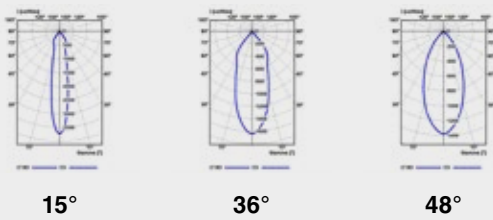

Option	Color T°	CRI	Power	Lumen Output	Beam Angle
927	2700K	90	2W	160lm / 163lm / 166lm	15° / 36° / 48°
930	3000K	90	2W	165lm / 168lm / 171lm	15° / 36° / 48°
940	4000K	90	2W	170lm / 173lm / 176lm	15° / 36° / 48°

Driver not included. See recommended drivers on page 428-429
Driver no incluido. Ver drivers recomendados en página 428-429

TROOP 3L

no incl. DIM 50.000hs L70 / B10 MacAdam 3 700mA 8.61V 650°C UGR <16



Family	Color T°	Beam Angle	Trim	Anti-Glare
43701 Troop Trim 3x2W	927 2700K CRI90	1 15°	0 Trimless	1 White
43705 Troop Trimless 3x2W	930 3000K CRI90	3 36°	1 White	2 Black
	940 4000K CRI90	4 48°	2 Black	4 Gold

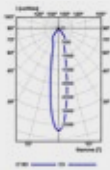

15°

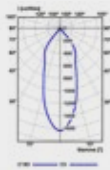

36°

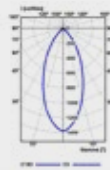

48°

Option	Color T°	CRI	Power	Lumen Output	Beam Angle
927	2700K	90	3x2W	425lm / 650lm / 493lm	15° / 36° / 48°
930	3000K	90	3x2W	438lm / 670lm / 508lm	15° / 36° / 48°
940	4000K	90	3x2W	451lm / 690lm / 523lm	15° / 36° / 48°

Driver not included. See recommended drivers on page 428-429
Driver no incluido. Ver drivers recomendados en página 428-429

TROOP 5L

no incl. DIM 50.000hs L70 / B10 MacAdam 3 700mA 14.28V 650°C UGR <16

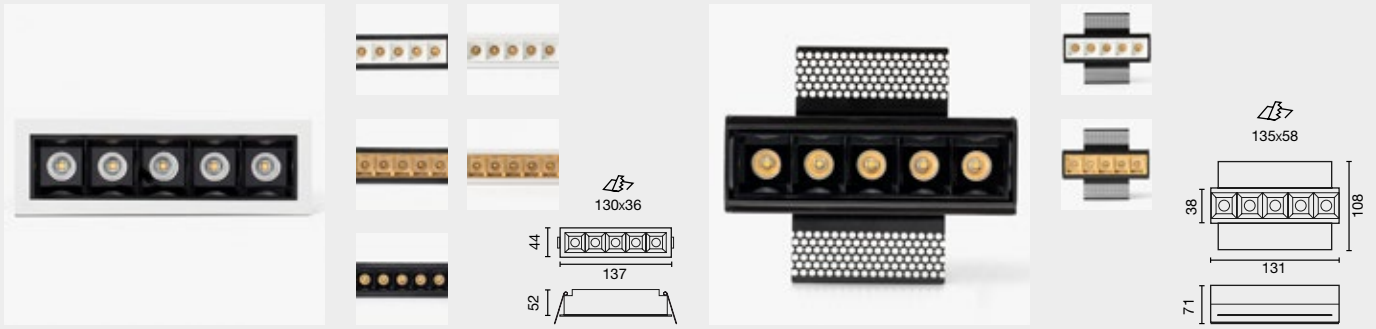

Family	Color T°	Beam Angle	Trim	Anti-Glare
43702 Troop Trim 5x2W	927 2700K CRI90	1 15°	0 Trimless	1 White
43706 Troop Trimless 5x2W	930 3000K CRI90	3 36°	1 White	2 Black
	940 4000K CRI90	4 48°	2 Black	4 Gold

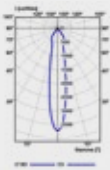

15°

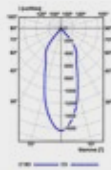

36°

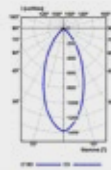

48°

Option	Color T°	CRI	Power	Lumen Output	Beam Angle
927	2700K	90	5x2W	672lm / 841lm / 828lm	15° / 36° / 48°
930	3000K	90	5x2W	692lm / 866lm / 853lm	15° / 36° / 48°
940	4000K	90	5x2W	712lm / 891lm / 878lm	15° / 36° / 48°

Driver not included. See recommended drivers on page 428-429
 Driver no incluido. Ver drivers recomendados en página 428-429

TROOP WALL WASHER

no incl. DIM 50.000hs L70 / B10 MacAdam 3 700mA 14.28V 650°C UGR <16

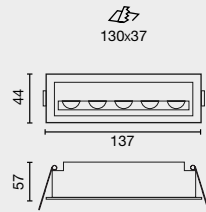

Family	Color T°	Beam Angle	Trim	Anti-Glare
43710 Troop Wall Washer 5x2W	927 2700K CRI90	0 Asymmetric	1 White	1 White
	930 3000K CRI90		2 Black	2 Black
	940 4000K CRI90			

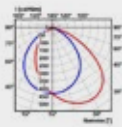

90°

Option	Color T°	CRI	Power	Lumen Output	Beam Angle
927	2700K	90	5x2W	519lm	90°
930	3000K	90	5x2W	535lm	90°
940	4000K	90	5x2W	551lm	90°

Driver not included. See recommended drivers on page 428-429
 Driver no incluido. Ver drivers recomendados en página 428-429

TROOP 10L

no incl. DIM 50.000hs L70 / B10 MacAdam 3 700mA 28.57V 650°C UGR <16

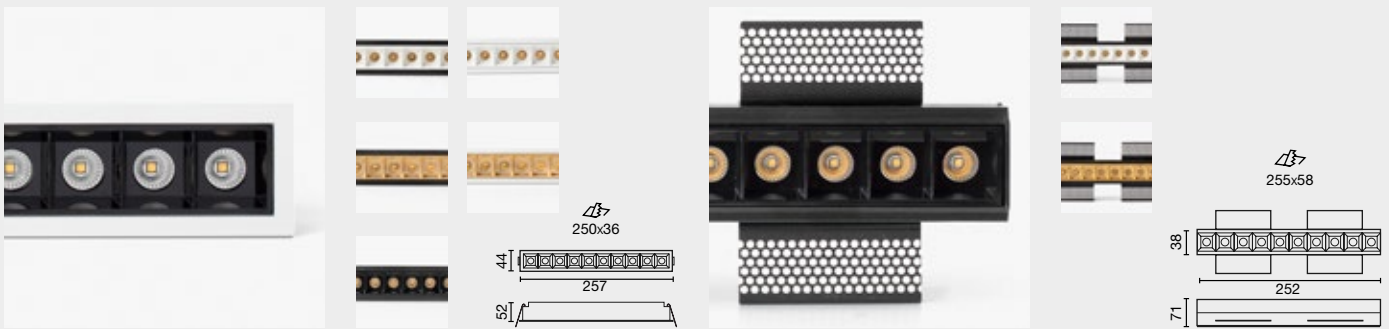

Family	Color T°	Beam Angle	Trim	Anti-Glare
43703 Troop Trim 10x2W	927 2700K CRI90	1 15°	0 Trimless	1 White
43707 Troop Trimless 10x2W	930 3000K CRI90	3 36°	1 White	2 Black
	940 4000K CRI90	4 48°	2 Black	4 Gold

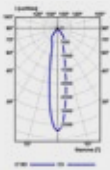

15°

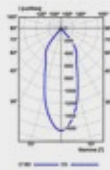

36°



48°

Option	Color T°	CRI	Power	Lumen Output	Beam Angle
927	2700K	90	10x2W	1379lm / 1681lm / 1755lm	15° / 36° / 48°
930	3000K	90	10x2W	1422lm / 1733lm / 1809lm	15° / 36° / 48°
940	4000K	90	10x2W	1465lm / 1785lm / 1863lm	15° / 36° / 48°

Driver not included. See recommended drivers on page 428-429
Driver no incluido. Ver drivers recomendados en página 428-429



**Need consulting
for your project?**
¿Necesitas
asesoramiento
para tu proyecto?















Squared luminaire available for 1,2 or 3 lamps. This family of luminaires is manufactured in different sizes and power so it is easy to find one that fits best to your lighting needs.

Colin es una serie de luminarias orientables de formato cuadrado/rectangular disponible para 1, 2 o 3 lámparas. La familia ofrece diferentes opciones de tamaños y potencias por lo que es fácil encontrar la que más se ajuste a vuestras necesidades de iluminación.



COLIN

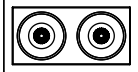

	TRIM Con marco			TRIMLESS Sin marco	
Colin Nano 7 / 13W					
	113x113	113x223		100x100	100x210
Colin Mini 18 / 25W					
	140x140	140x295	140x435		
Colin 24 / 36W					
	173x173	173x343	173x512		

FINISH
Acabado

● **Black**
Negro

○ **White**
Blanco

● **Grey**
Gris

COLOR TEMPERATURE
Temperatura de color

2700K CRI82	3000K CRI85	4000K CRI85
2700K CRI95	3000K CRI95	4000K CRI95
MEAT	BREAD	FASHION

BEAM ANGLE
Ángulo de apertura



CONTROL SYSTEM
Sistema de control



CASAMBI



Highlights

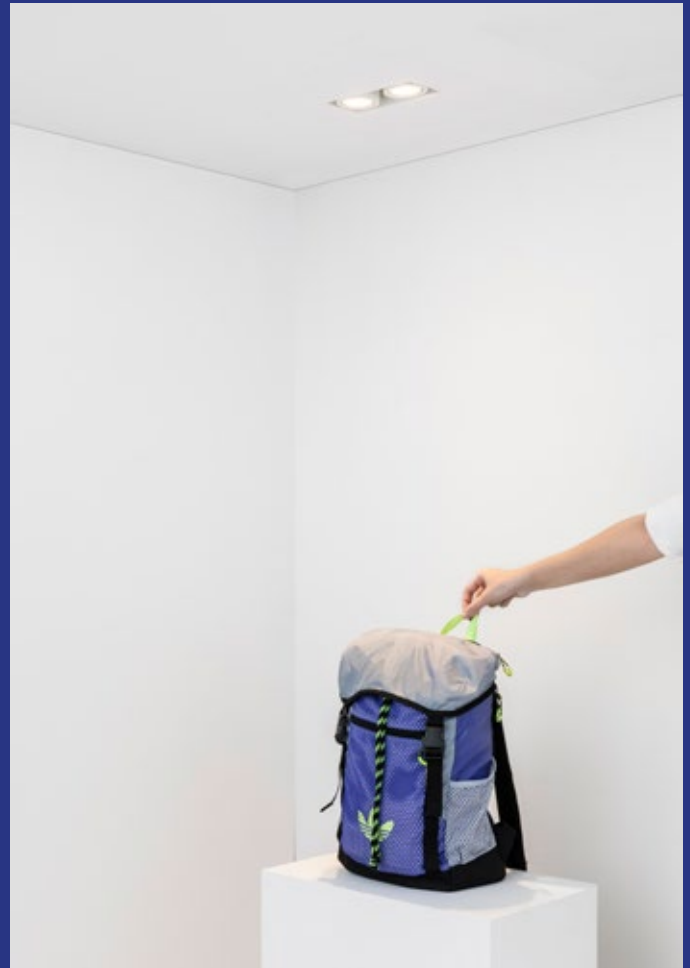

Different sizes
Diversos tamaños



Cardanic orientation
Orientación cardánica



High CRI
Alto IRC



Several color temperatures
Varias temperaturas de color

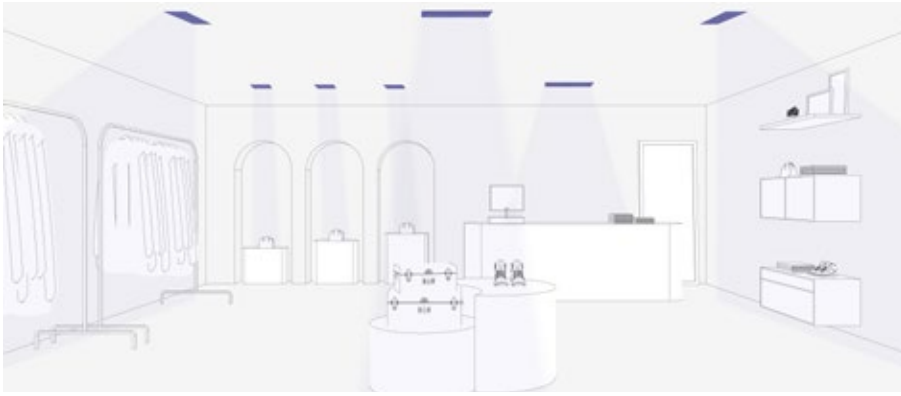

Retail

Beam Angle

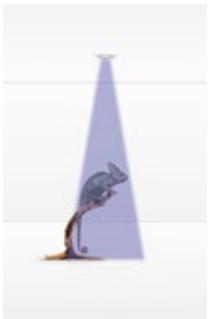

20°

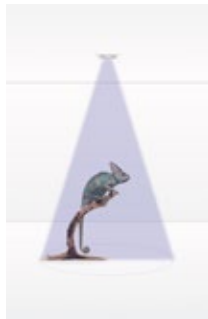

56°

COLIN NANO 1L

no incl. DIM 20° 50.000hs L80 / B10 MacAdam 3 7W 13W 200mA 34V 350mA 35V 650°C

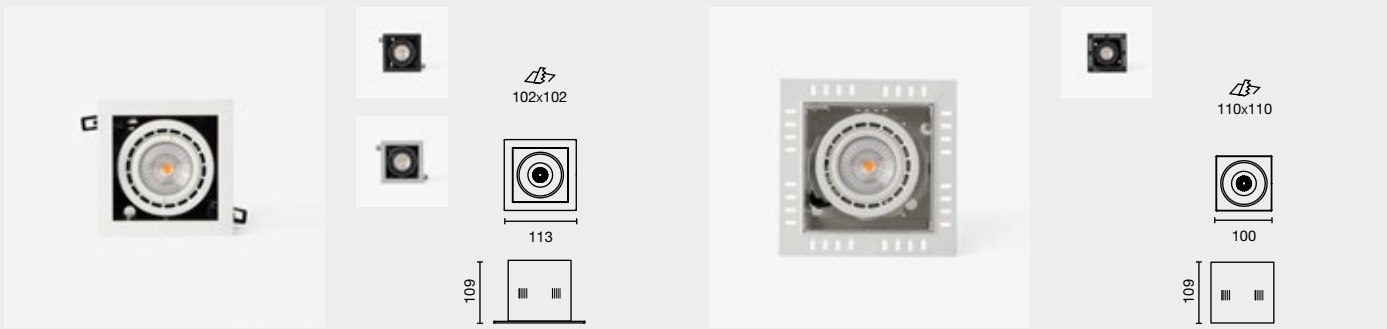

Family

035000	Colin Nano 7 / 13W
035100	Colin Nano Trimless 7 / 13W

Color T°

10	2700K CRI82 20°
20	2700K CRI82 56°
30	3000K CRI85 20°
40	3000K CRI85 56°
50	4000K CRI85 20°
60	4000K CRI85 56°

Finish

1	White
2	Black
3	Grey (available only for trim)

035000

10

1

Example **035000101** — Colin Nano 7W 2700K CRI82 20° White

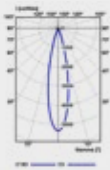

20°

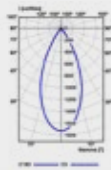

56°

Color T°	CRI	Power	Lumen Output	Beam Angle
2700K	82	7W / 13W	691lm / 1120lm	20° / 56°
3000K	85	7W / 13W	712lm / 1155lm	20° / 56°
4000K	85	7W / 13W	733lm / 1190lm	20° / 56°

Driver not included. See recommended drivers on page 428-429
Driver no incluido. Ver drivers recomendados en página 428-429

COLIN NANO 2L

no incl. DIM 20° 50.000hs L80 / B10 MacAdam 3 2x7W 200mA 34V 2x13W 350mA 35V 650°C

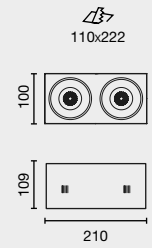
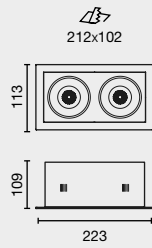

Family

035005	Colin Nano 2L 14 / 26W
035105	Colin Nano 2L Trimless 14 / 26W

Color T°

00	2700K CRI82 20°
10	2700K CRI82 56°
20	3000K CRI85 20°
30	3000K CRI85 56°
40	4000K CRI85 20°
50	4000K CRI85 56°

Finish

1	White
2	Black
3	Grey (available only for trim)

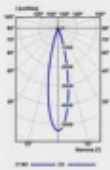

20°

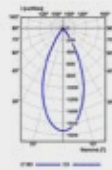

56°

Color T°	CRI	Power	Lumen Output	Beam Angle
2700K	82	2x7W / 2x13W	2x691lm / 2x1120lm	20° / 56°
3000K	85	2x7W / 2x13W	2x712lm / 2x1155lm	20° / 56°
4000K	85	2x7W / 2x13W	2x733lm / 2x1190lm	20° / 56°

Driver not included. See recommended drivers on page 428-429
Driver no incluido. Ver drivers recomendados en página 428-429

COLIN MINI 1L

no incl. DIM 20° 50.000hs L80 / B10 MacAdam 3 18W 25W 500mA 33V 700mA 34V 650°C

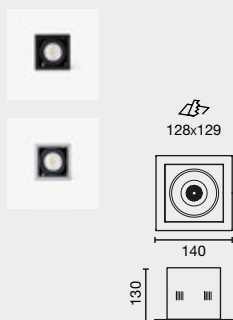
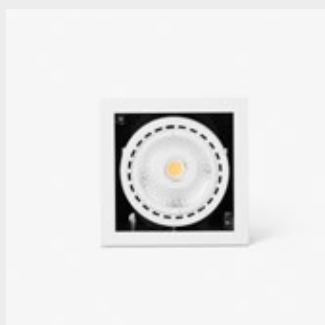

Family	Color T°	Finish	
033008 Colin Mini 18 / 25W	30 2700K CRI82 20°	1 White	
	40 2700K CRI82 56°	2 Black	
	50 3000K CRI85 20°	3 Grey	
	60 3000K CRI85 56°		
	70 4000K CRI85 20°		
	80 4000K CRI85 56°		
03300 CRI95	890 2700K CRI95 20°	1 White	
	900 2700K CRI95 56°	2 Black	
	910 3000K CRI95 20°	3 Grey	
	920 3000K CRI95 56°		
	930 4000K CRI95 20°		
	940 4000K CRI95 56°		
03301 Food	011 BREAD 2500K CRI88 20°	1 White	
	021 BREAD 2500K CRI88 56°	2 Black	
	031 MEAT CRI82 20°	3 Grey	
	041 MEAT CRI82 56°		
03301 Fashion	050 3100K CRI95 20°	1 White	
	060 3100K CRI95 56°	2 Black	
		3 Grey	

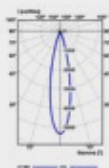

20°

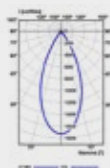

56°

Color T°	CRI	Power	Lumen Output	Beam Angle
2700K	82	18W / 25W	1642lm / 2193lm	20° / 56°
	95		1361lm / 1882lm	
3000K	85	18W / 25W	1693lm / 2261lm	20° / 56°
	95		1403lm / 1878lm	
4000K	85	18W / 25W	1744lm / 2329lm	20° / 56°
	95		1445lm / 1934lm	
MEAT	82	18W / 25W	1335lm	20° / 56°
BREAD 2500K	88	18W / 25W	1801lm	20° / 56°
FASHION 3100K	95	18W / 25W	1841lm	20° / 56°

Driver not included. See recommended drivers on page 428-429
 Driver no incluido. Ver drivers recomendados en página 428-429

COLIN MINI 2L

no incl. DIM 20° 50.000hs L80 / B10 MacAdam 3 2x18W 2x 25W 500mA 33V 700mA 34V 650°C



Family	Color T°	Finish	
03301 Colin Mini 2L 36 / 50W	090 2700K CRI82 20°	1 White	
	100 2700K CRI82 56°	2 Black	
	110 3000K CRI85 20°	3 Grey	
	120 3000K CRI85 56°		
	130 4000K CRI85 20°		
	140 4000K CRI85 56°		
	03301 CRI95	150 2700K CRI95 20°	1 White
		160 2700K CRI95 56°	2 Black
		170 3000K CRI95 20°	3 Grey
		180 3000K CRI95 56°	
190 4000K CRI95 20°			
200 4000K CRI95 56°			
03301 Food	271 BREAD 2500K CRI88 20°	1 White	
	281 BREAD 2500K CRI88 56°	2 Black	
	291 MEAT CRI82 20°	3 Grey	
	301 MEAT CRI82 56°		
03301 Fashion	330 3100K CRI95 20°	1 White	
	340 3100K CRI95 56°	2 Black	
		3 Grey	

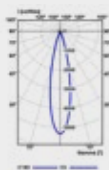

20°



56°

Color T°	CRI	Power	Lumen Output	Beam Angle
2700K	82	2x18W / 2x25W	2x1642lm / 2x2193lm	20° / 56°
	95		2x1361lm / 2x1882lm	
3000K	82	2x18W / 2x25W	2x1693lm / 2x2261lm	20° / 56°
	95		2x1403lm / 2x1878lm	
4000K	82	2x18W / 2x25W	2x1744lm / 2x2329lm	20° / 56°
	95		2x1445lm / 2x1934lm	
MEAT	82	2x18W / 2x25W	2x1335lm	20° / 56°
BREAD 2500K	88	2x18W / 2x25W	2x1801lm	20° / 56°
FASHION 3100K	95	2x18W / 2x25W	2x1841lm	20° / 56°

Driver not included. See recommended drivers on page 428-429
 Driver no incluido. Ver drivers recomendados en página 428-429

COLIN MINI 3L

no incl. DIM 20° 50.000hs L80 / B10 MacAdam 3 3x18W 3x25W 500mA 33V 700mA 34V 650°C

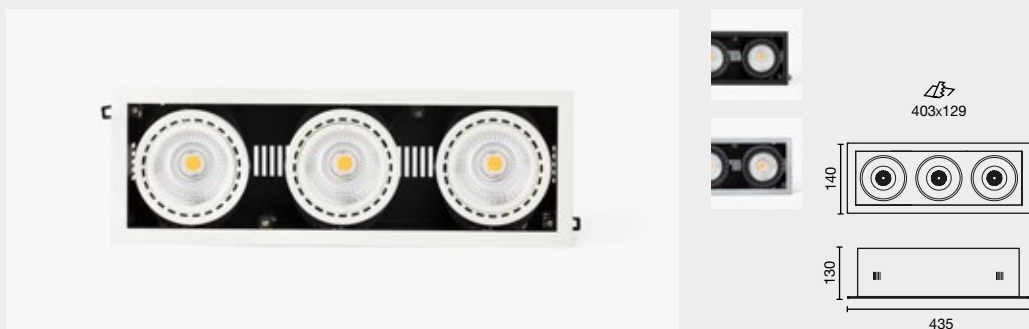

Family	Color T°	Finish	
03301 Colin Mini 3L 54 / 75W	350 2700K CRI82 20°	1 White	
	360 2700K CRI82 56°	2 Black	
	370 3000K CRI85 20°	3 Grey	
	380 3000K CRI85 56°		
	390 4000K CRI85 20°		
	400 4000K CRI85 56°		
	03301 CRI95	410 2700K CRI95 20°	1 White
		420 2700K CRI95 56°	2 Black
		430 3000K CRI95 20°	3 Grey
		440 3000K CRI95 56°	
450 4000K CRI95 20°			
460 4000K CRI95 56°			
03301 Food	531 BREAD 2500K CRI88 20°	1 White	
	541 BREAD 2500K CRI88 56°	2 Black	
	551 MEAT CRI82 20°	3 Grey	
	561 MEAT CRI82 56°		
03301 Fashion	590 3100K CRI95 20°	1 White	
	600 3100K CRI95 56°	2 Black	
		3 Grey	

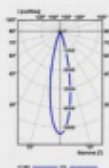

20°

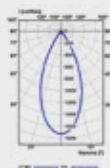

56°

Color T°	CRI	Power	Lumen Output	Beam Angle
2700K	82	3x18W / 3x25W	3x1642lm / 3x2193lm	20° / 56°
	95		3x1361lm / 3x1882lm	
3000K	82	3x18W / 3x25W	3x1693lm / 3x2261lm	20° / 56°
	95		3x1403lm / 3x1878lm	
4000K	82	3x18W / 3x25W	3x1744lm / 3x2329lm	20° / 56°
	95		3x1445lm / 3x1934lm	
MEAT	82	3x18W / 3x25W	3x1335lm	20° / 56°
BREAD 2500K	88	3x18W / 3x25W	3x1801lm	20° / 56°
FASHION 3100K	95	3x18W / 3x25W	3x1841lm	20° / 56°

Driver not included. See recommended drivers on page 428-429
 Driver no incluido. Ver drivers recomendados en página 428-429

COLIN 1L

no incl. DIM 20° 50.000hs L80 / B10 MacAdam 3 24W 36W 700mA 33V 1050mA 34V 650°C

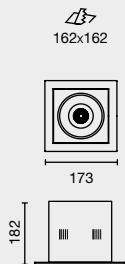
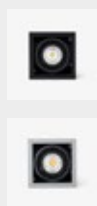
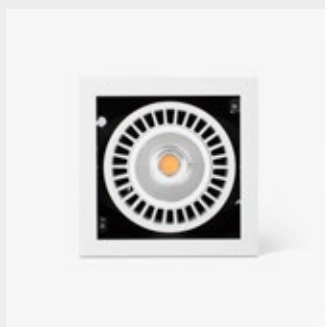

Family	Color T°	Finish
--------	----------	--------

03400 Colin 24 / 36W	850 2700K CRI82 20°	1 White
	860 2700K CRI82 56°	2 Black
	870 3000K CRI85 20°	3 Grey
	880 3000K CRI85 56°	
	890 4000K CRI85 20°	
	900 4000K CRI85 56°	

03400 CRI95	910 2700K CRI95 20°	1 White
	920 2700K CRI95 56°	2 Black
	930 3000K CRI95 20°	3 Grey
	940 3000K CRI95 56°	
	950 4000K CRI95 20°	
	960 4000K CRI95 56°	

03401 Food	031 BREAD 2500K CRI88 20°	1 White
	041 BREAD 2500K CRI88 56°	2 Black
	051 MEAT CRI82 20°	3 Grey
	061 MEAT CRI82 56°	

03401 Fashion	090 3100K CRI95 20°	1 White
	100 3100K CRI95 56°	2 Black
		3 Grey

0340040 Colin QR-111 LED G53 12V max.12W		1 White
		2 Black
		3 Grey

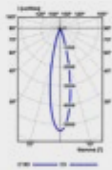

20°

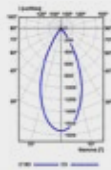

56°

Color T°	CRI	Power	Lumen Output	Beam Angle
2700K	82	24 / 36W	2167lm / 3066lm	20° / 56°
	95		2072lm / 2930lm	
3000K	85	24 / 36W	2234lm / 3161lm	20° / 56°
	95		2136lm / 3021lm	
4000K	85	24 / 36W	2301lm / 3256lm	20° / 56°
	95		2200lm / 3112lm	
MEAT	82	24 / 36W	1406lm / 2023lm	20° / 56°
BREAD 2500K	88	24 / 36W	1912lm / 2750lm	20° / 56°
FASHION 3100K	95	24 / 36W	1977lm / 2844lm	20° / 56°

Driver not included. See recommended drivers on page 428-429
 Driver no incluido. Ver drivers recomendados en página 428-429

COLIN 2L

no incl. DIM 20° 50.000hs L80 / B10 MacAdam 3 2x24W 2x36W 700mA 33V 1050mA 34V 650°C

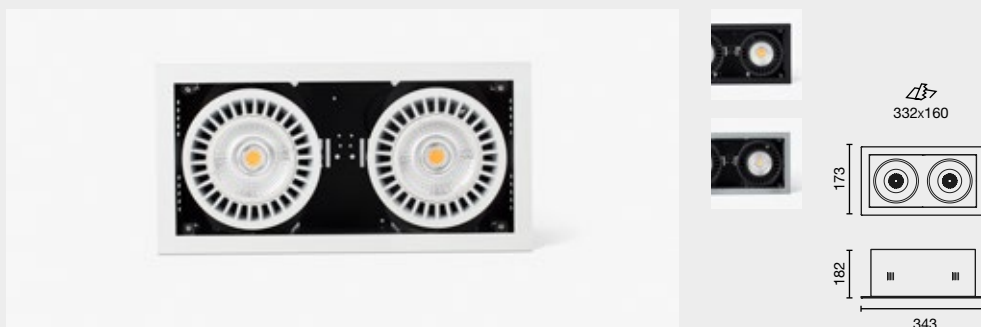

Family	Color T°	Finish
03401 Colin 3L 48 / 72W	110 2700K CRI82 20°	1 White
	120 2700K CRI82 56°	2 Black
	130 3000K CRI85 20°	3 Grey
	140 3000K CRI85 56°	
	150 4000K CRI85 20°	
	160 4000K CRI85 56°	
03401 CRI95	170 2700K CRI95 20°	1 White
	180 2700K CRI95 56°	2 Black
	190 3000K CRI95 20°	3 Grey
	200 3000K CRI95 56°	
	210 4000K CRI95 20°	
	220 4000K CRI95 56°	
03401 Food	291 BREAD 2500K CRI88 20°	1 White
	301 BREAD 2500K CRI88 56°	2 Black
	311 MEAT CRI82 20°	3 Grey
	321 MEAT CRI82 56°	
03401 Fashion	350 3100K CRI95 20°	1 White
	360 3100K CRI95 56°	2 Black
		3 Grey
0340050 Colin 2L QR-111 LED G53 12V max.12W		1 White
		2 Black
		3 Grey

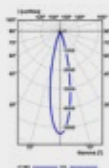

20°



56°

Color T°	CRI	Power	Lumen Output	Beam Angle
2700K	82	2x24 / 2x36W	2x2167lm / 2x3066lm	20° / 56°
	95		2x2072lm / 2x2930lm	
3000K	85	2x24 / 2x36W	2x2234lm / 2x3161lm	20° / 56°
	95		2x2136lm / 2x3021lm	
4000K	85	2x24 / 2x36W	2x2301lm / 2x3256lm	20° / 56°
	95		2x2200lm / 2x3112lm	
MEAT	82	2x24 / 2x36W	2x1406lm / 2x2023lm	20° / 56°
BREAD 2500K	88	2x24 / 2x36W	2x1912lm / 2x2750lm	20° / 56°
FASHION 3100K	95	2x24 / 2x36W	2x1977lm / 2x2844lm	20° / 56°

Driver not included. See recommended drivers on page 428-429
 Driver no incluido. Ver drivers recomendados en página 428-429

COLIN 3L

no incl. DIM 20° 50.000hs L80 / B10 MacAdam 3 3x24W 3x36W 700mA 33V 1050mA 34V 650°C



Family	Color T°	Finish
03401 Colin 3L 72 / 108W	370 2700K CRI82 20°	1 White
	380 2700K CRI82 56°	2 Black
	390 3000K CRI85 20°	3 Grey
	400 3000K CRI85 56°	
	410 4000K CRI85 20°	
420 4000K CRI85 56°		
03401 CRI95	370 2700K CRI82 20°	1 White
	380 2700K CRI82 56°	2 Black
	390 3000K CRI82 20°	3 Grey
	400 3000K CRI82 56°	
	410 4000K CRI82 20°	
420 4000K CRI82 56°		
03401 Food	551 BREAD 2500K CRI88 20°	1 White
	561 BREAD 2500K CRI88 56°	2 Black
	571 MEAT CRI82 20°	3 Grey
	581 MEAT CRI82 56°	
03401 Fashion	610 3100K CRI95 20°	1 White
	620 3100K CRI95 56°	2 Black
		3 Grey
0340060 Colin 3L QR-111 LED G53 12V max.12W		1 White
		2 Black
		3 Grey

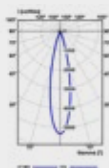

20°

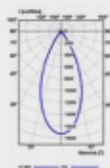

56°

Color T°	CRI	Power	Lumen Output	Beam Angle
2700K	82	3x24 / 3x36W	3x2167lm / 3x3066lm	20° / 56°
	95		3x2072lm / 3x2930lm	
3000K	85	3x24 / 3x36W	3x2234lm / 3x3161lm	20° / 56°
	95		3x2136lm / 3x3021lm	
4000K	85	3x24 / 3x36W	3x2301lm / 3x3256lm	20° / 56°
	95		3x2200lm / 3x3112lm	
MEAT	82	3x24 / 3x36W	3x1406lm / 3x2023lm	20° / 56°
BREAD 2500K	88	3x24 / 3x36W	3x1912lm / 3x2750lm	20° / 56°
FASHION 3100K	95	3x24 / 3x36W	3x1977lm / 3x2844lm	20° / 56°

Driver not included. See recommended drivers on page 428-429
 Driver no incluido. Ver drivers recomendados en página 428-429

Luminaire in a round adjustable format. This family of luminaires is manufactured in different sizes and powers so it is easy to find the one that best suits your lighting needs.

Luminaria de formato redondo orientable. Esta familia de luminarias se fabrica en diferentes tamaños y potencias por lo que es fácil encontrar la que más se ajuste a vuestras necesidades de iluminación.



OPTIC





Optic Mini
18 / 25W



ø140

Optic
24 / 36W



ø165

FINISH
Acabado

● **Black**
Negro

○ **White**
Blanco

● **Grey**
Gris

COLOR TEMPERATURE
Temperatura de color

2700K CRI82

3000K CRI85

4000K CRI85

2700K CRI95

3000K CRI95

4000K CRI95

MEAT

BREAD

FASHION

BEAM ANGLE
Ángulo de apertura

20°

56°

CONTROL SYSTEM
Sistema de control



CASAMBI



Highlights

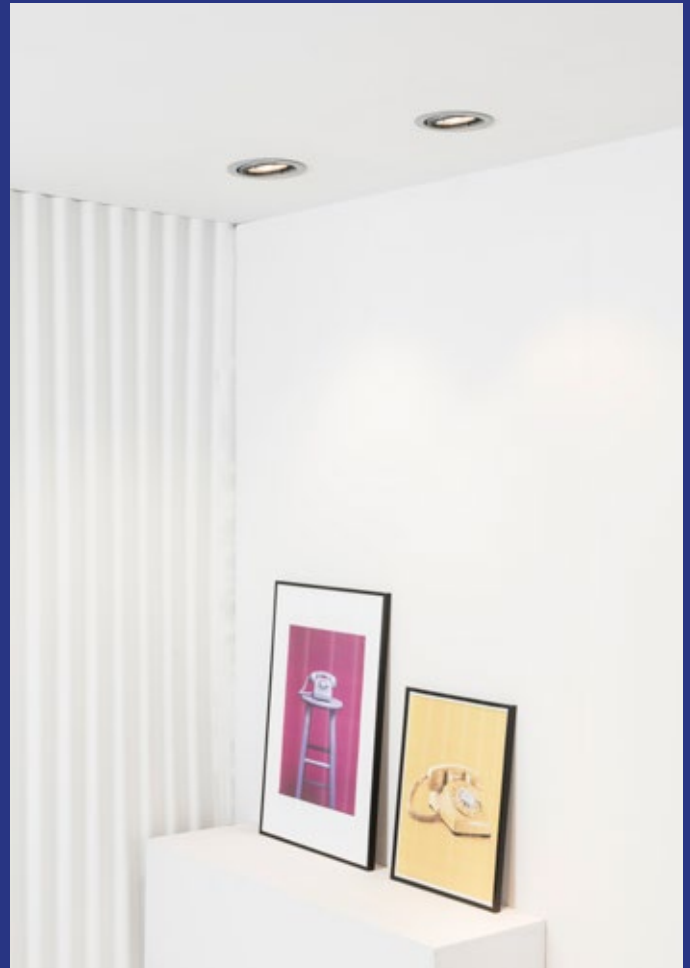

Different sizes
Diversos tamaños



Cardanic orientation
Orientación cardánica



High CRI
Alto IRC



Several color temperatures
Varias temperaturas de color

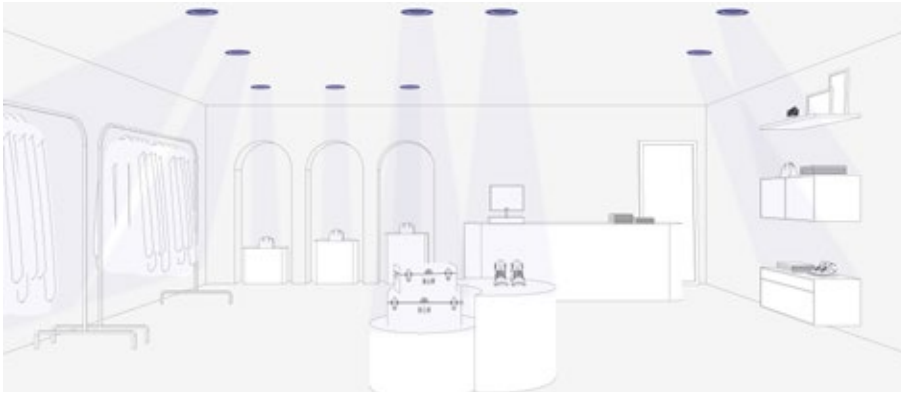

Retail

Beam Angle

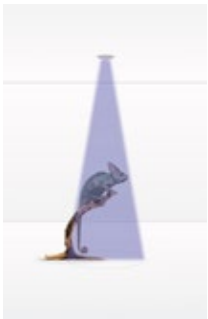

20°

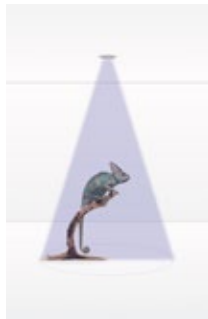

56°

OPTIC MINI

no incl. DIM 20° 50.000hs L80 / B10 MacAdam 3 18W 25W 500mA 33V 700mA 34V 650°C

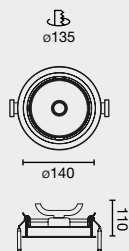
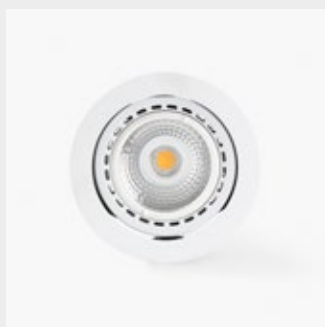

Family	Color T°	Finish
03250 Optic Mini 18 / 25W	300 2700K CRI82 20°	1 White
	310 2700K CRI82 56°	2 Black
	320 3000K CRI85 20°	3 Grey
	330 3000K CRI85 56°	
	340 4000K CRI85 20°	
	350 4000K CRI85 56°	
03250 CRI95	360 2700K CRI95 20°	1 White
	370 2700K CRI95 56°	2 Black
	380 3000K CRI95 20°	3 Grey
	390 3000K CRI95 56°	
	400 4000K CRI95 20°	
	410 4000K CRI95 56°	
03250 Food	481 BREAD 2500K CRI88 20°	1 White
	491 BREAD 2500K CRI88 56°	2 Black
	501 MEAT CRI82 20°	3 Grey
	511 MEAT CRI82 56°	
03250 Fashion	541 3100K CRI95 20°	1 White
	551 3100K CRI95 56°	2 Black
		3 Grey

03250 300 1

Example **032503001** — Optic Mini 18W 2700K CRI82 20° White

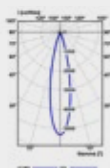

20°

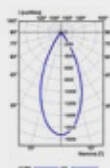

56°

Color T°	CRI	Power	Lumen Output	Beam Angle
2700K	82	18W / 25W	1642lm / 2193lm	20° / 56°
	95		1361lm / 1882lm	
3000K	85	18W / 25W	1693lm / 2261lm	20° / 56°
	95		1403lm / 1878lm	
4000K	85	18W / 25W	1744lm / 2329lm	20° / 56°
	95		1445lm / 1934lm	
MEAT	82	18W / 25W	1335lm	20° / 56°
BREAD 2500K	88	18W / 25W	1801lm	20° / 56°
FASHION 3100K	95	18W / 25W	1841lm	20° / 56°

Driver not included. See recommended drivers on page 428-429
 Driver no incluido. Ver drivers recomendados en página 428-429

OPTIC

no incl. DIM 20° 50.000hs L80 / B10 MacAdam 3 24W 36W 700mA 33V 1050mA 34V 650°C

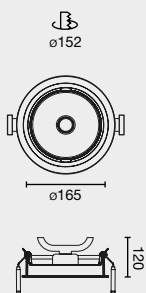

Family	Color T°	Finish
03200 Optic 24 / 36W	300 2700K CRI82 20°	1 White
	310 2700K CRI82 56°	2 Black
	320 3000K CRI85 20°	
	330 3000K CRI85 56°	
	340 4000K CRI85 20°	
	350 4000K CRI85 56°	
03200 CRI95	360 2700K CRI95 20°	1 White
	370 2700K CRI95 56°	2 Black
	380 3000K CRI95 20°	
	390 3000K CRI95 56°	
	400 4000K CRI95 20°	
	410 4000K CRI95 56°	
03200 Food	481 BREAD 2500K CRI88 20°	1 White
	491 BREAD 2500K CRI88 56°	2 Black
	501 MEAT CRI82 20°	
	511 MEAT CRI82 56°	
03200 Fashion	541 3100K CRI95 20°	1 White
	551 3100K CRI95 56°	2 Black

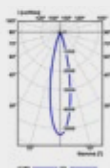

20°

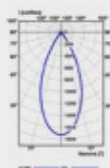

56°

Color T°	CRI	Power	Lumen Output	Beam Angle
2700K	82	24 / 36W	2167lm / 3066lm	20° / 56°
	95		2072lm / 2930lm	
3000K	85	24 / 36W	2234lm / 3161lm	20° / 56°
	95		2136lm / 3021lm	
4000K	85	24 / 36W	2301lm / 3256lm	20° / 56°
	95		2200lm / 3112lm	
MEAT	82	24 / 36W	1406lm / 2023lm	20° / 56°
BREAD 2500K	88	24 / 36W	1912lm / 2750lm	20° / 56°
FASHION 3100K	95	24 / 36W	1977lm / 2844lm	20° / 56°

Driver not included. See recommended drivers on page 428-429
 Driver no incluido. Ver drivers recomendados en página 428-429



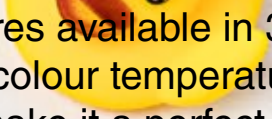

CROC is a family of recessed light fixtures available in 3 different sizes: 100 mm, 135 mm and 180 mm. Its different colour temperature options and its microprismatic optics for glare control make it a perfect option for work zones and spaces dedicated to healthcare. It has IP44 for humid zones and a low recess height.

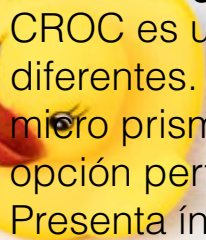

CROC es una familia de luminarias empotrables disponible en 3 tamaños diferentes. Sus diferentes opciones de temperatura de color y su óptica micro prismática para el control del deslumbramiento la convierten en una opción perfecta para zonas de trabajo y espacios dedicados a la salud. Presenta índice de protección 44 para zonas húmedas y una baja cota de empotramiento.



CROC





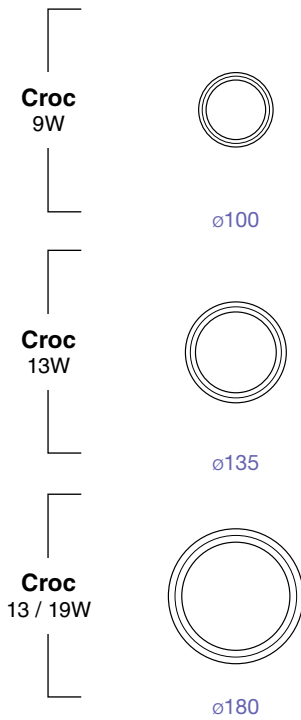

FINISH
Acabado

○ **White**
Blanco

COLOR TEMPERATURE
Temperatura de color

2700K CRI90

3000K CRI90

4000K CRI90

2700-6500K

BEAM ANGLE
Ángulo de apertura

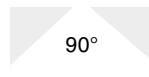

CONTROL SYSTEM
Sistema de control



CASAMBI



Highlights



Different sizes
Diversos tamaños

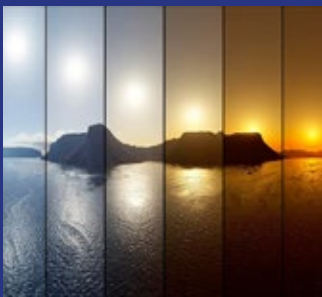

Tunable white

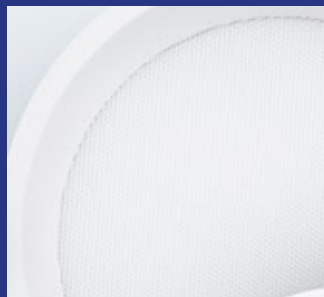

Micro-prismatic optics
Óptica micro prismática



IP 54/44



Several color temperatures
Varias temperaturas de color



CROC 9W

incl. DIM 50,000hs L70 / B10 MacAdam 3 IP 54/44 220- 50/ 240V 60Hz 650°C

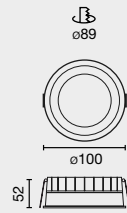

Family	Color T°	Beam Angle	Finish	Control System
43780 CROC 9W	927 2700K CRI90 930 3000K CRI90 940 4000K CRI90	9 90°	1 White	W CASAMBI D BALI C TRAC ON/OFF

43780 927 9 1 W

Example **4378092791W** — CROC 9W 2700K 90° White Casambi

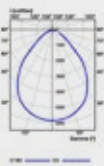

90°

Option	Color T°	CRI	Power	Lumen Output	Beam Angle
927	4000K	90	13W	1070lm	90°
930	3000K	90	13W	1039lm	90°
940	2700K	90	13W	1009lm	90°

CROC 13W

incl. DIM 50.000hs L70 / B10 MacAdam 3 IP 54/44 220- 50/ 240V 60Hz 650°C UGR <19

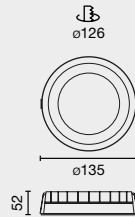

Family	Color T°	Beam Angle	Finish	Control System
43781 Croc 13W	<p>927 2700K CRI90</p> <p>930 3000K CRI90</p> <p>940 4000K CRI90</p>	9 90°	1 White	<p>W CASAMBI</p> <p>D DALI</p> <p>C TRAC</p> <p>ON/OFF</p>

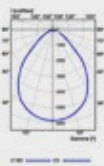

90°

Option	Color T°	CRI	Power	Lumen Output	Beam Angle
927	4000K	90	13W	1495lm	90°
930	3000K	90	13W	1452lm	90°
940	2700K	90	13W	1409lm	90°

CROC 13/19W

incl. DIM 50,000hs L70 / B10 MacAdam 3 IP 54/44 220- 50/ 240V 60Hz 650°C

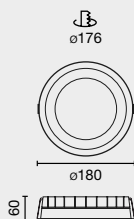
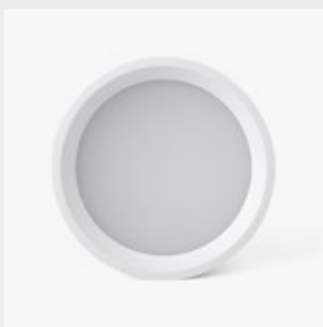

Family	Color T°	Beam Angle	Finish	Control System								
43782 Croc 19W	927 2700K CRI90	9 90°	1 White	<table border="1"> <tr><td>W</td><td>CASAMBI</td></tr> <tr><td>D</td><td>DALI</td></tr> <tr><td>C</td><td>TRAC</td></tr> <tr><td></td><td>ON/OFF</td></tr> </table>	W	CASAMBI	D	DALI	C	TRAC		ON/OFF
W	CASAMBI											
D	DALI											
C	TRAC											
	ON/OFF											
43783 Croc 13W UGR<19	930 3000K CRI90 940 4000K CRI90											
N 43784 Croc 19W Ø180	TW 2700-6500K	9 90°	1 White	<table border="1"> <tr><td>W</td><td>CASAMBI</td></tr> <tr><td>D</td><td>DALI</td></tr> </table>	W	CASAMBI	D	DALI				
W	CASAMBI											
D	DALI											

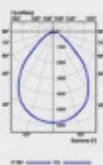

90°

Option	Color T°	CRI	Power	Lumen Output	Beam Angle
927	4000K	90	19W	2844lm	90°
930	3000K	90	19W	2762lm	90°
940	2700K	90	19W	2681lm	90°
TW	2000-6500K	90	19W	1773lm	90°
UGR<19					
927	4000K	90	13W	1662lm	90°
930	3000K	90	13W	1665lm	90°
940	2700K	90	13W	1616lm	90°



The BACKLIGHT panels are the perfect choice for efficiency and illuminating offices in an elegant way. These recessed panels provide soft and uniform lighting that promotes a comfortable and productive environment. Their discreet design easily integrates into the aesthetics of any office space. The uniform lighting they offer helps reduce glare and improve visual quality in the workplace.

Los paneles BACKLIGHT son la elección perfecta para iluminar oficinas de manera eficiente y elegante. Estos paneles empotrables proporcionan una iluminación suave y uniforme que favorece un ambiente confortable y productivo. Su diseño discreto se integra fácilmente en la estética de cualquier espacio de oficina. La iluminación uniforme que ofrece contribuye a reducir el deslumbramiento y a mejorar la calidad visual en el lugar de trabajo.



BACK

LIGHT





Backlight
1195x295mm
36W

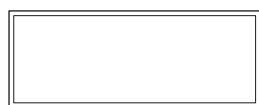

Backlight
595mm
36W



FINISH
Acabado

White
Blanco

COLOR TEMPERATURE
Temperatura de color

3000K CRI80

4000K CRI80

BEAM ANGLE
Ángulo de apertura



CONTROL SYSTEM
Sistema de control



Highlights

Thanks to its easy installation and high energy efficiency, this panel becomes the ideal option for providing general lighting in large spaces. With a UGR glare index below 19, it is a perfect choice for office environments.

Gracias a su sencilla instalación y su alta eficiencia energética, este panel se convierte en la opción ideal para proveer iluminación general en espacios amplios. Con un índice de deslumbramiento UGR inferior a 19, resulta una elección perfecta para entornos de oficina.

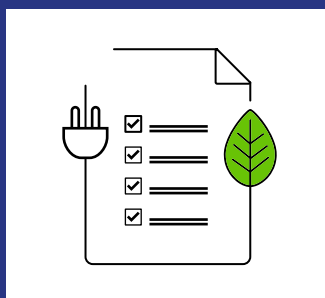

High Efficiency
Alta eficiencia



Easy Instalation modular ceiling
Techo modular de fácil instalación

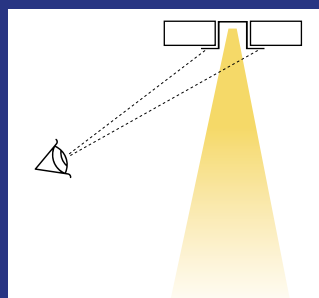

UGR<19



Office

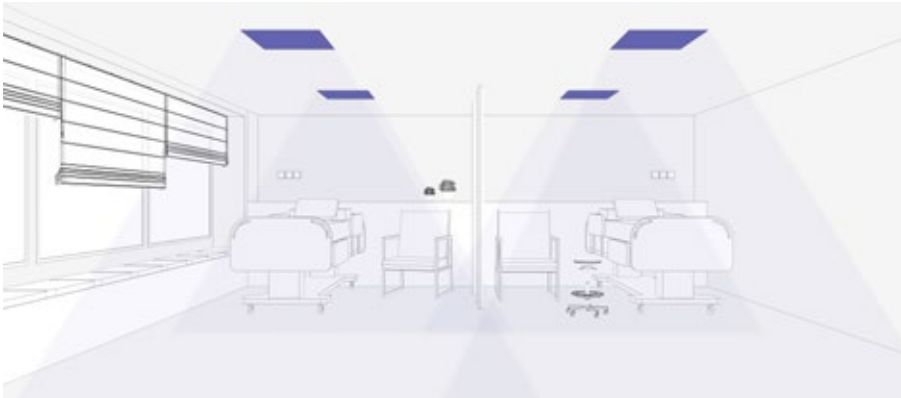

Hospital

Beam Angle



90°

BACKLIGHT 36W



incl. DIM 50.000hs L80 / B10 MacAdam 3 220- 50/ 240V 60Hz 650°C UGR <19

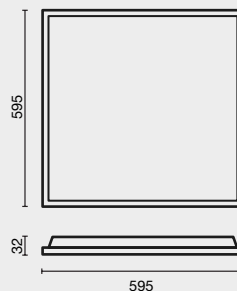
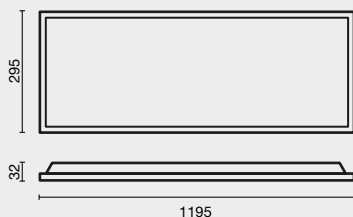

Family	Color T°	Beam Angle	Finish	Control System
0363 Backlight 1195x295 36W	830 3000K CRI80	9 90°	1 White	D DALI W CASAMBI ON/OFF
0364 Backlight 595x595 36W	840 4000K CRI80			

0363 830 9 1 D
 Example **036383091D** — Backlight 1195x295 36W 3000K CRI80 90° White Dali

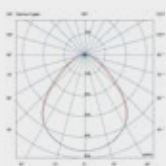

90°

Option	Color T°	CRI	Power	Lumen Output	Beam Angle
830	3000K	80	36W	4499lm	90°
840	4000K	80	36W	4638lm	90°







FOOST

RECESSED

Recessed projector with an optical block designed to meet the highest requirements of accent lighting. This product offers an elegant and efficient solution to highlight specific spaces, providing exceptional quality accent lighting. Its recessed design makes it ideal for discreet integration into various environments, ensuring optimal performance in creating accentuated lighting effects. Proyector empotrable con un bloque óptico diseñado para satisfacer las más altas exigencias de iluminación de acento. Este producto ofrece una solución elegante y eficiente para resaltar espacios específicos, proporcionando una iluminación de calidad excepcional. Su diseño empotrable lo hace ideal para integrarse de manera discreta en diversos entornos, garantizando un rendimiento óptimo en la creación de efectos de iluminación acentuada.



FOST Collection



Track
47



Pulldown
181



Ceiling
277



Surface
267



Pendant
323

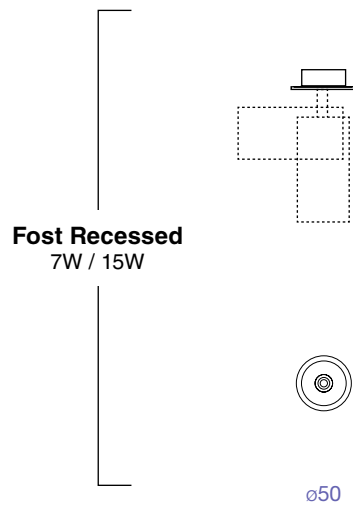

FINISH
Acabado

● **Black**
Negro

○ **White**
Blanco

COLOR TEMPERATURE
Temperatura de color

2700K CRI90	3000K CRI90	4000K CRI90
2700K CRI97	3000K CRI97	4000K CRI97

BEAM ANGLE
Ángulo de apertura



ACCESSORIES
Accesorios

○
White Ring

○
Copper Ring

CONTROL SYSTEM
Sistema de control



Highlights



Anti-glare
Anti deslumbramiento



High CRI
Alto IRC



Several color temperatures
Varias temperaturas de color



Need consulting
for your project?
¿Necesitas
asesoramiento
para tu proyecto?





White Ring



Copper Ring

Accessories

	White Ring	Copper Ring
ø50	011600099	011600098

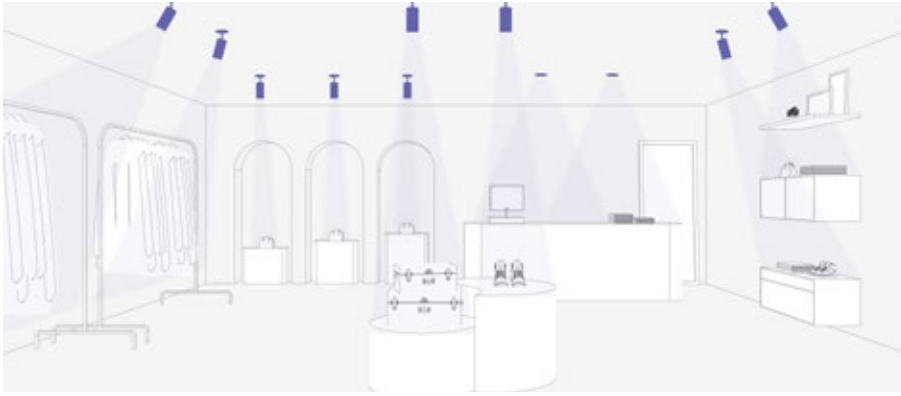

Retail



Restaurant

Beam Angle



12°



20°



35°

FOST RECESSED



incl. DIM 355° 90° 50.000hs L70 / B10 MacAdam 2&3 220-240V 50 / 60Hz 650°C

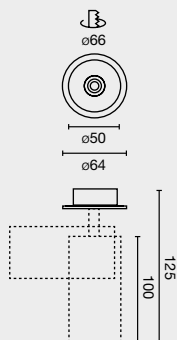

Family	Color T°	Beam Angle	Finish	Control System
0124 Fost Recessed 7W	927 2700K CRI90	1 12°	1 White	D DALI ON/OFF
	930 3000K CRI90	2 20°	2 Black	
	940 4000K CRI90	3 35°		
	X27 2700K CRI97			
	X30 3000K CRI97			
	X40 4000K CRI97			

0125 Fost Recessed 15W	927 2700K CRI90	1 12°	1 White	W CASAMBI D DALI ON/OFF
	930 3000K CRI90	2 20°	2 Black	
	940 4000K CRI90	3 35°		
	X27 2700K CRI97			
	X30 3000K CRI97			
	X40 4000K CRI97			

0125 927 1 1 W

Example 012592711W — Fost Recessed 15W 2700K CRI90 12° White Casambi

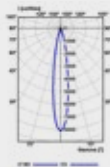

12°

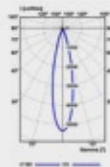

20°

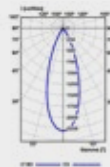

35°

Option	Color T°	CRI	Power	Lumen Output	Beam Angle
927	2700K	90	7W	1026lm / 973lm / 988lm	15°/25°/35°
x27		97	7W	933lm / 884lm / 899lm	15°/25°/35°
930		3000K	90	7W	1057lm / 1002lm / 1018lm
x30	97		7W	961lm / 911lm / 925lm	15°/25°/35°
940	4000K		90	7W	1089lm / 1032lm / 1049lm
x40		97	7W	990lm / 938lm / 953lm	15°/25°/35°
927		2700K	90	15W	641lm / 608lm / 618lm
X27	97		15W	583lm / 553lm / 562lm	12° / 20° / 35°
930	3000K		90	15W	661lm / 626lm / 636lm
X30		97	15W	601lm / 569lm / 578lm	12° / 20° / 35°
940		4000K	90	15W	680lm / 645lm / 655lm
X40	97		15W	619lm / 586lm / 596lm	12° / 20° / 35°







FOST

PULLDOWN

Recessed light fixture designed to fulfill the downlight function with the possibility to be converted into a 100% functional projector thanks to its optical block extraction system, enabling it to meet the highest requirements of accent lighting. This characteristic grants FOST PULLDOWN a flexibility suitable for any multifunctional spaces that require its adaptation or modification from a fixed point.

Luminaria empotrada diseñada para cumplir la función de downlight y con posibilidad de convertirse en un proyector 100% funcional, gracias a su sistema de extracción del bloque óptico que le permite cumplir las máximas exigencias de una iluminación de acento. Esta característica le otorga a FOST PULLDOWN una flexibilidad idónea para espacios multifuncionales, que requieran una adaptación o modificación de éste desde un punto fijo.



FOST Collection



Track
47



Recessed
171



Ceiling
277



Surface
267



Pendant
323

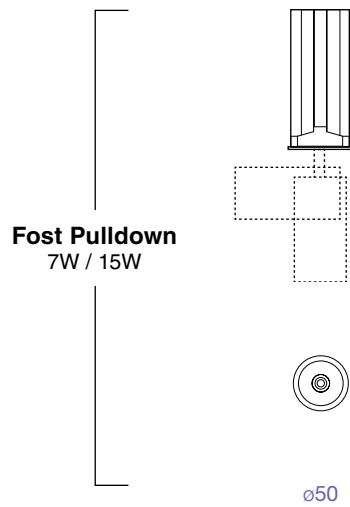

FINISH
Acabado

● **Black**
Negro

○ **White**
Blanco

COLOR TEMPERATURE
Temperatura de color

2700K CRI90	3000K CRI90	4000K CRI90
2700K CRI97	3000K CRI97	4000K CRI97

BEAM ANGLE
Ángulo de apertura



ACCESSORIES
Accesorios

○
White Ring

○
Copper Ring

CONTROL SYSTEM
Sistema de control



Highlights



Its extraction system enables the block to be positioned at different heights without limiting creativity, creating a decorative geometric effect while lighting the space.

Su sistema de extracción permite posicionar el bloque a diferentes alturas sin límites para la creatividad y generando un efecto geométrico decorativo a la vez que ilumina el espacio.

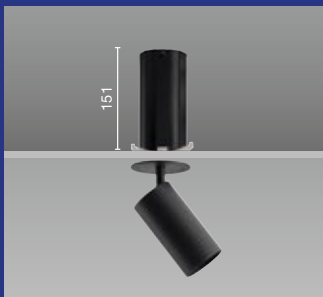

Consider the installation height in your project
Tenga en cuenta la altura de la instalación en su proyecto



High CRI
Alto IRC



Several color temperatures
Varias temperaturas de color





White Ring



Copper Ring

Accessories

	White Ring	Copper Ring
ø50	011600099	011600098

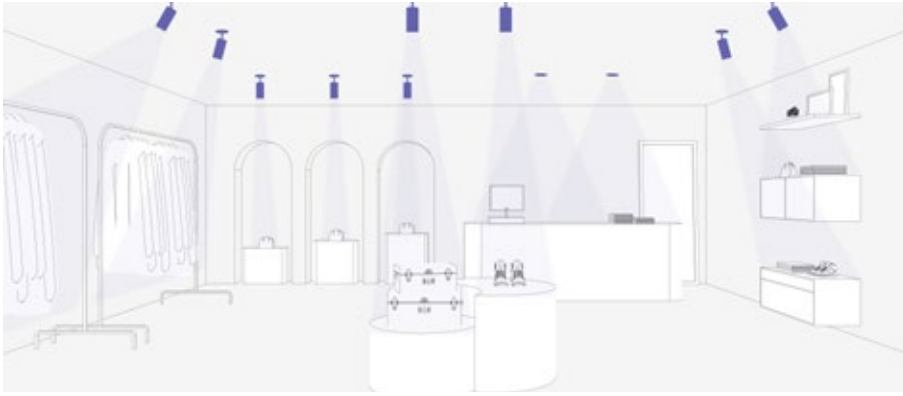

Retail



Restaurant

Beam Angle

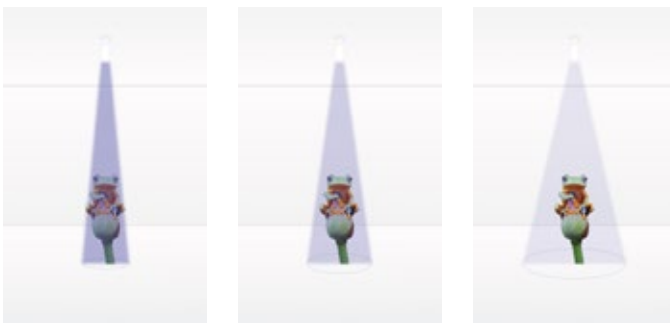

12°

20°

35°

FOST PULLDOWN

incl. DIM 355° 90° 50.000hs L70 / B10 MacAdam 2&3 220-240V 50 / 60Hz 650°C

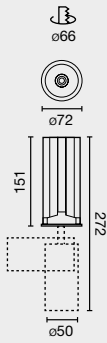

Family

Color T°

Beam Angle

Finish

Control System

N

0123 Fost Pulldown 7W

- 927** 2700K CRI90
- 930** 3000K CRI90
- 940** 4000K CRI90
- X27** 2700K CRI97
- X30** 3000K CRI97
- X40** 4000K CRI97

- 1** 12°
- 2** 20°
- 3** 35°

- 1** White
- 2** Black

D **ON/OFF**

0122 Fost Pulldown 15W

- 927** 2700K CRI90
- 930** 3000K CRI90
- 940** 4000K CRI90
- X27** 2700K CRI97
- X30** 3000K CRI97
- X40** 4000K CRI97

- 1** 12°
- 2** 20°
- 3** 35°

- 1** White
- 2** Black

W **D** **ON/OFF**

0122

927

1

1

W

Example **012292711W** — Fost Pulldown 15W 2700K CRI90 12° White Casambi

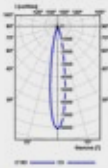

12°

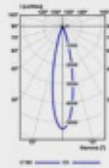

20°

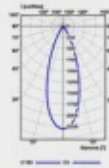

35°

Option	Color T°	CRI	Power	Lumen Output	Beam Angle
927	2700K	90	7W	1026lm / 973lm / 988lm	15°/25°/35°
x27		97	7W	933lm / 884lm / 899lm	15°/25°/35°
930	3000K	90	7W	1057lm / 1002lm / 1018lm	15°/25°/35°
x30		97	7W	961lm / 911lm / 925lm	15°/25°/35°
940	4000K	90	7W	1089lm / 1032lm / 1049lm	15°/25°/35°
x40		97	7W	990lm / 938lm / 953lm	15°/25°/35°
927	2700K	90	15W	641lm / 608lm / 618lm	12° / 20° / 35°
X27		97	15W	583lm / 553lm / 562lm	12° / 20° / 35°
930	3000K	90	15W	661lm / 626lm / 636lm	12° / 20° / 35°
X30		97	15W	601lm / 569lm / 578lm	12° / 20° / 35°
940	4000K	90	15W	680lm / 645lm / 655lm	12° / 20° / 35°
X40		97	15W	619lm / 586lm / 596lm	12° / 20° / 35°



Size does matter. UNO has a design that is small in dimension and a large capacity to create environments with light with minimum visual invasion, both in the space and on the recess surface.

El tamaño sí importa. UNO presenta un diseño de reducidas dimensiones y una gran capacidad de crear entornos con luz con la mínima invasión visual, tanto en el espacio como en la superficie de empotramiento.



UNO





FINISH
Acabado

● **Black+Black**
Negro+Negro

◐ **Black+White**
Negro+Blanco

○ **White+White**
Blanco+Blanco

◑ **White+Black**
Blanco+Negro

◒ **Black+Gold**
Negro+Oro

◓ **White+Gold**
Blanco+Oro

COLOR TEMPERATURE
Temperatura de color

2700K CRI90

3000K CRI90

BEAM ANGLE
Ángulo de apertura

11°

24°

37°

ACCESSORIES
Accesorios



Honeycomb

CONTROL SYSTEM
Sistema de control



Highlights



The size/flow ratio of its downlight and extractable projector versions makes it possible to fulfill the requirements needed for applications in hotels, restaurants and retail, as well as its domestic application.

La relación tamaño-flujo de sus versiones downlight y proyector extraíble hacen posible que, además de su aplicación doméstica, cumpla con las exigencias requeridas para aplicaciones en hoteles, restaurantes y retail.



Passive heat dissipation system
Sistema de disipación térmica pasiva

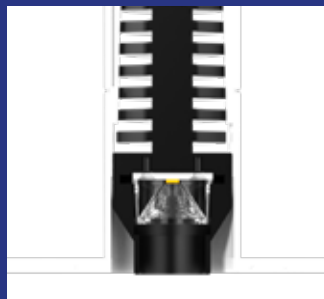

Glare control
Control de deslumbramiento



Removable downlight module
Módulo downlight extraíble a presión



Several color temperatures
Varias temperaturas de color





Honeycomb

Accessories

Honeycomb

35300099

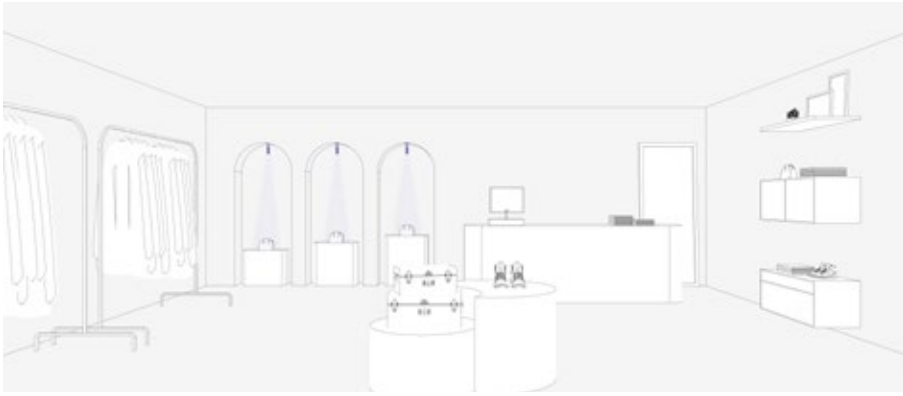

Retail



Restaurant



Residential

Beam Angle



11°



24°

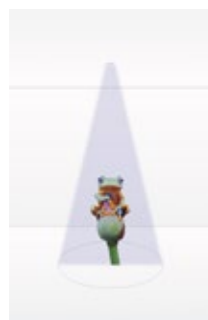

37°

UNO DOWNLIGHT 8W

incl. DIM 50.000hs L70 / B10 MacAdam 3 220-240V 50 / 60Hz 650°C

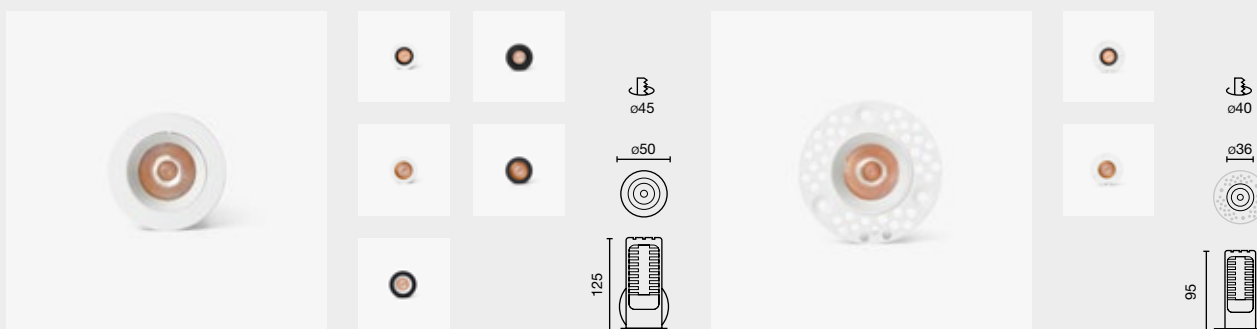

Family	Color T°	Beam Angle	Finish	Ring	Control System
0331 Uno Trim 8W	927 2700K CRI90	1 11°	1 White	1 White	D DALI
0332 Uno Trimless 8W	930 3000K CRI90	2 24°	2 Black	2 Black	ON/OFF
		3 37°		4 Gold	

0331 **927** **1** **1** **1** **D**

Example **0331927111W** — Uno trim 8W 2700K CRI90 11° White, White Ring Dali

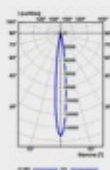

11°

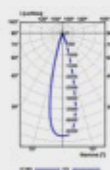

24°

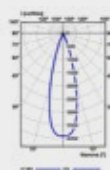

37°

Option	Color T°	CRI	Power	Lumen Output	Beam Angle
927	2700K	90	8W	347lm / 346lm / 331lm	11° / 24° / 37°
930	3000K	90	8W	358lm / 357lm / 341lm	11° / 24° / 37°

UNO PULLDOWN PROJECTOR 8W

incl. DIM 355° 90° 50.000hs L70 / B10 MacAdam 3 220-240V 50 / 60Hz 650°C

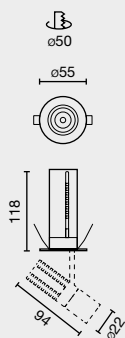
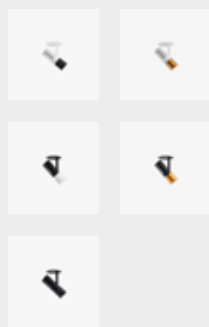

Family	Color T°	Beam Angle	Finish	Ring	Control System
0333 Uno Pulldown 8W	927 2700K CRI90	1 11°	1 White	1 White	D ON/OFF
	930 3000K CRI90	2 24°	2 Black	2 Black	
		3 37°		4 Gold	

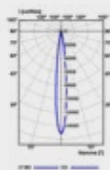

11°

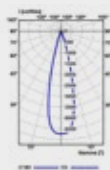

24°

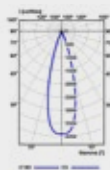

37°

Option	Color T°	CRI	Power	Lumen Output	Beam Angle
927	2700K	90	8W	347lm / 346lm / 331lm	11° / 24° / 37°
930	3000K	90	8W	358lm / 357lm / 341lm	11° / 24° / 37°

TEIDE is a modular system of recessed light fixtures which stands out for its great versatility, high visual comfort and the orientability of its modules. Minimalist in design, it offers a broad integration with architecture, ideal for residential and retail use. Committed to lighting excellence with CRI97 and 2 MacAdam options.

TEIDE es un sistema modular de luminarias de empotrar que destaca por su gran versatilidad, alto confort visual y la orientabilidad de sus módulos. De diseño minimalista, ofrece una amplia integración con la arquitectura, ideal para uso residencial y retail. Apuesta por la excelencia lumínica con las opciones IRC97 y 2 MacAdam.



TEIDE



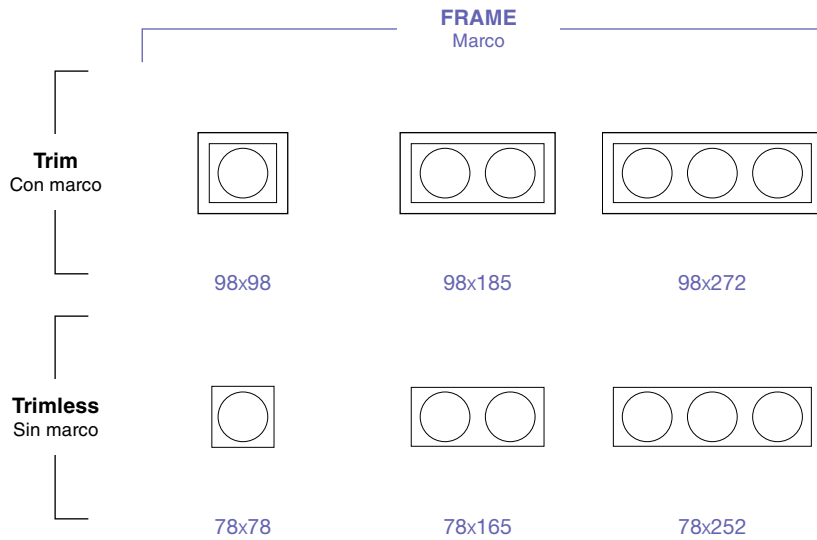
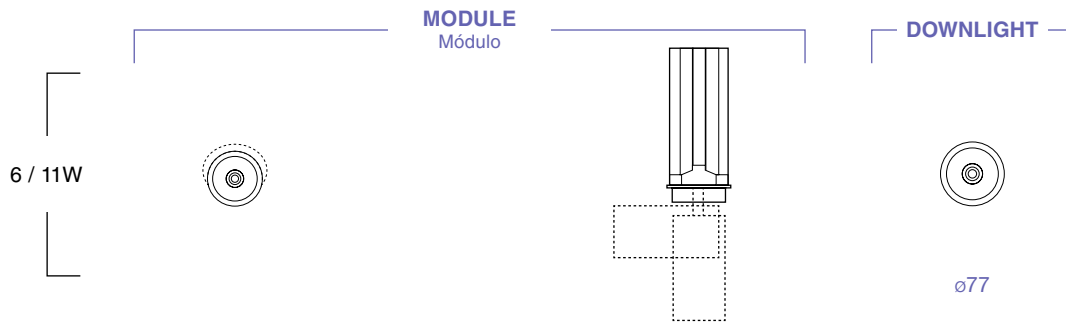

FINISH
Acabado

- **Black**
Negro
- **White**
Blanco

COLOR TEMPERATURE
Temperatura de color

- 2700K CRI90
- 3000K CRI90
- 2700K CRI97
- 3000K CRI97

BEAM ANGLE
Ángulo de apertura

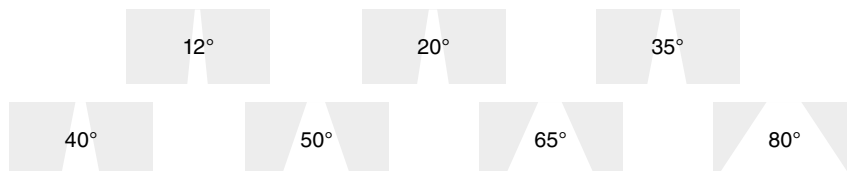

CONTROL SYSTEM
Sistema de control



Highlights

Teide system

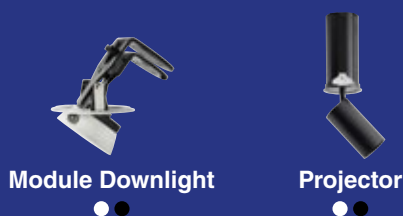

The system consists of a round downlight module and a spotlight module that can be combined in square/rectangular recessed frames with 1, 2 and 3 lights (also available in frameless version). The downlight module is also available in a round hole installation version, TEIDE Downlight.

El sistema se compone de un módulo redondo tipo downlight y de otro tipo proyector que se pueden combinar entre sí en marcos de empotrar cuadrados/rectangulares de 1, 2 y 3 luces (también disponibles en versión sin marco). El módulo tipo downlight está además disponible en su versión de instalación para agujero redondo, TEIDE Downlight.



Pulldown projector module

Teide downlight



Orientation without light loss
Orientación sin pérdida de luz



Trim 1L



Trim 2L

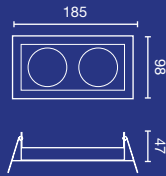

Trim 3L

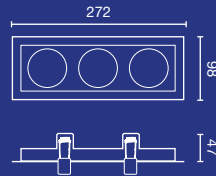

Trimless 1L

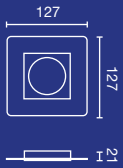

Trimless 2L

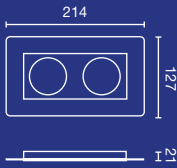

Trimless 3L

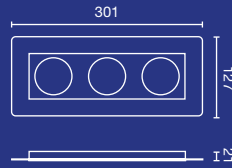

Frames

Trim 1L	Trim 2L	Trim 3L	Trimless 1L	Trimless 2L	Trimless 3L
● 034600011	● 034600021	● 034600031	● 034700011	● 034700021	● 034700031
● 034600012	● 034600022	● 034600032	● 034700012	● 034700022	● 034700032

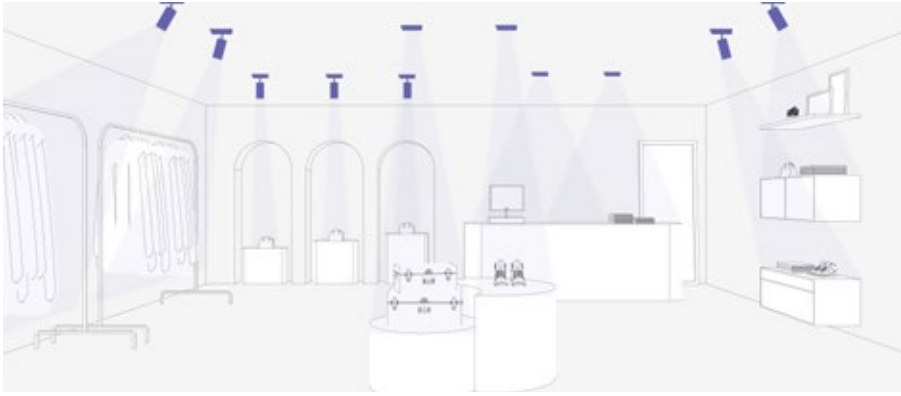

Retail



Restaurant

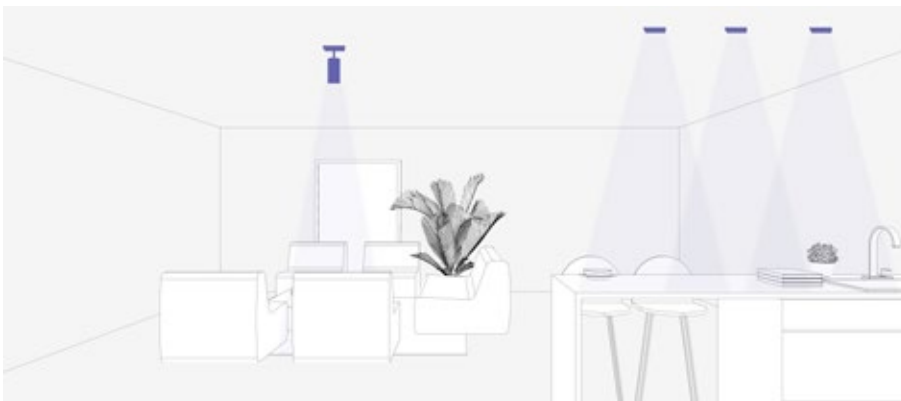

Residential

Beam Angle Downlight

Beam Angle Projector



40°

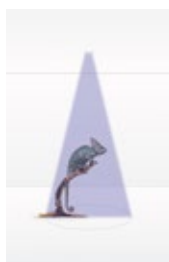

50°

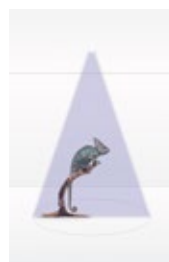

65°

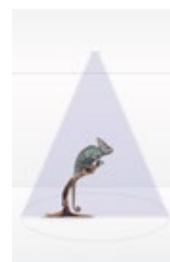

80°

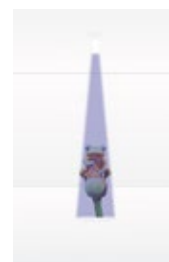

12°



20°



35°

TEIDE PROJECTOR MODULE

incl. DIM 355° 80° 50.000hs L70 / B10 MacAdam 2&3 220-240V 50 / 60Hz 650°C

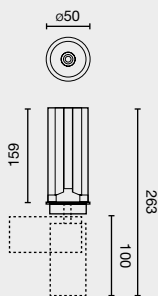

Family	Color T°	Beam Angle	Finish	Control System
0349 Teide Projector Module 9W	927 2700K CRI90	1 12° 2 20° 3 35°	1 White	D ON/OFF
	930 3000K CRI90		2 Black	
	X27 2700K CRI97			
	X30 3000K CRI97			

0349 927 1 1 W

Example 034992711D — Teide Projector Module 9W 2700K CRI90 12° White Dali

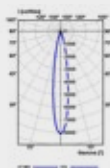

12°

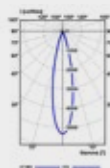

20°

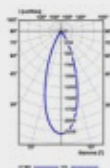

35°

Option	Color T°	CRI	Power	Lumen Output	Beam Angle
927	2700K	90	9W	741lm / 754lm / 782lm	12° / 20° / 35°
X27		97	9W	667lm / 678lm / 703lm	12° / 20° / 35°
930	3000K	90	9W	764lm / 777lm / 806lm	12° / 20° / 35°
X30		97	9W	687lm / 699lm / 725lm	12° / 20° / 35°

See frame options on page 206
Ver opciones de marco en página 206



TEIDE DOWNLIGHT MODULE

incl. DIM 355° 45° 50.000hs L70 / B10 MacAdam 2&3 220-240V 50 / 60Hz 650°C

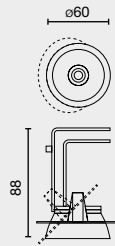

Family	Color T°	Beam Angle	Finish	Control System
0352 Teide Downlight Module 10W	927 2700K CRI90	4 40°	1 White	D  ON/OFF
	930 3000K CRI90	5 50°	2 Black	
	X27 2700K CRI97	6 65°		
	X30 3000K CRI97	8 80°		

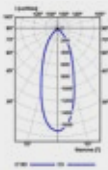

40°

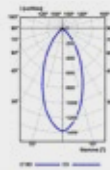

50°



65°

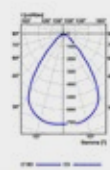

80°

Option	Color T°	CRI	Power	Lumen Output	Beam Angle
927	2700K	90	10W	774lm / 769lm / 783lm / 812lm	40° / 50° / 65° / 80°
X27		97	10W	697lm / 692lm / 704lm / 731lm	40° / 50° / 65° / 80°
930	3000K	90	10W	798lm / 793lm / 807lm / 837lm	40° / 50° / 65° / 80°
X30		97	10W	718lm / 714lm / 726lm / 753lm	40° / 50° / 65° / 80°

See frame options on page 206
Ver opciones de marco en página 206

TEIDE DOWNLIGHT

incl. DIM 355° 45° 50.000hs L70 / B10 MacAdam 2&3 220-240V 50 / 60Hz 650°C



Family	Color T°	Beam Angle	Finish	Control System
0348 Teide Downlight 10W	927 2700K CRI90	4 40°	1 White	D  ON/OFF
	930 3000K CRI90	5 50°	2 Black	
	X27 2700K CRI97	6 65°		
	X30 3000K CRI97	8 80°		

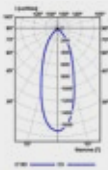

40°

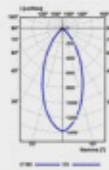

50°



65°

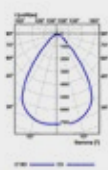

80°

Option	Color T°	CRI	Power	Lumen Output	Beam Angle
927	2700K	90	10W	774lm / 769lm / 783lm / 812lm	40° / 50° / 65° / 80°
X27		97	10W	697lm / 692lm / 704lm / 731lm	40° / 50° / 65° / 80°
930	3000K	90	10W	798lm / 793lm / 807lm / 837lm	40° / 50° / 65° / 80°
X30		97	10W	718lm / 714lm / 726lm / 753lm	40° / 50° / 65° / 80°

See frame options on page 206
Ver opciones de marco en página 206

TULIPA is the ideal solution when light quality and great visual comfort are needed. Downlight with aluminium injection frame and high-quality finishes which, thanks to its cut-off and its integrated honeycomb, guarantees maximum visual comfort.

TULIPA es la solución ideal cuando se precisa calidad de luz y gran confort visual. Downlight con marco de inyección de aluminio y acabados de alta calidad que, gracias a su cut-off y su panel de abeja integrado, garantiza el máximo confort visual.



TULIPA





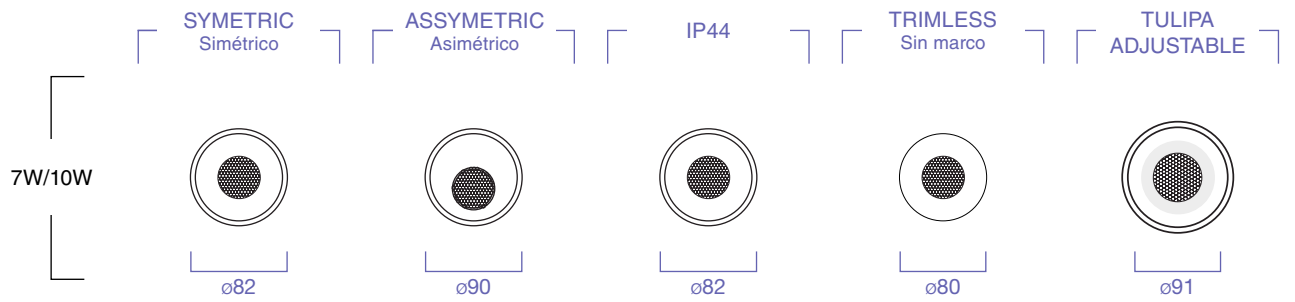

FINISH
Acabado

- Black**
Negro
- White**
Blanco



COLOR TEMPERATURE
Temperatura de color

- 2700K CRI90
- 3000K CRI90
- 4000K CRI90

BEAM ANGLE
Ángulo de apertura



ACCESSORIES
Accesorios

- 
Supplementary
White Ring
- 
Supplementary
Black Ring

CONTROL SYSTEM
Sistema de control



Highlights

Optical block formed by a secondary aluminium injection reflector which at the same time functions as a recess ring, integrated honeycomb, along with a high-purity PMMA lens.

Bloque óptico formado por un reflector secundario de inyección de aluminio que a la vez ejerce de aro de empotramiento, panel de abeja integrado junto con una lente de PMMA de alta pureza.



Built-in Honeycomb
Panel de abeja incorporado



Symmetric / Asymmetric / Adjustable
Simétrico / Asimétrico / Orientable



Simple clipping system
Sistema de clipaje simple



Optional IP44
Opción IP44



High CRI
Alto IRC



Several color temperatures
Varias temperaturas de color



Need consulting
for your project?
¿Necesitas
asesoramiento
para tu proyecto?





**Supplementary
White Ring**

ø96 supplementary ring

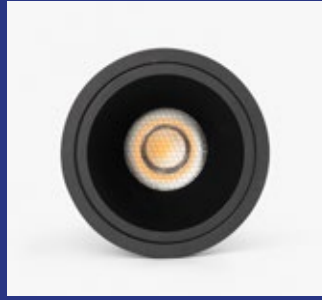

**Supplementary
Black Ring**

ø96 supplementary ring

Accessories

**Supplementary
White Ring**

033500098

**Supplementary
Black Ring**

033500099



Residential



Office



Restaurant

Beam Angle



15°



24°

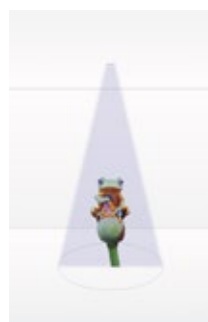

36°

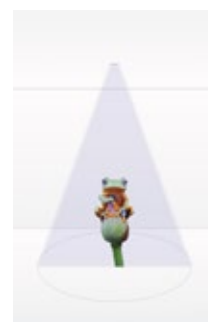

55°

TULIPA

incl. DIM 50.000hs L80 / B10 MacAdam 3 220-240V 50 / 60Hz 650°C

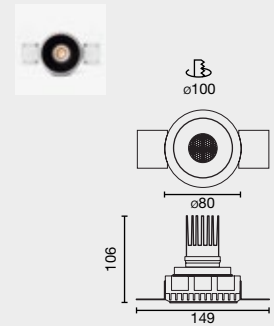
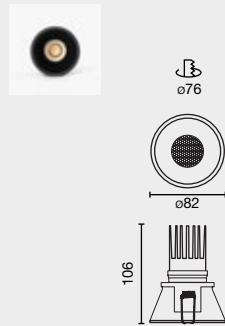

Family	Power	Color T°	Beam Angle	Finish	Control System
0335 Tulipa Trim	1 7W 350mA	927 2700K CRI90	1 15°	1 White	W CASAMBI
0337 Tulipa Trim IP44	2 10W 500mA	930 3000K CRI90	2 24°	2 Black	D DALI
0338 Tulipa Trimless		940 4000K CRI90	3 36°		C TRAC
			5 55°		ON/OFF

0335 **1** **927** **1** **1** **W**

Example **0335192711W** — Tulipa trim 7W 350mA 2700K CRI90 15° White Casambi

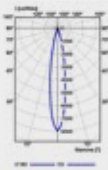

15°

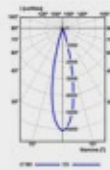

24°

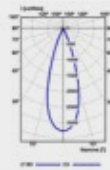

36°

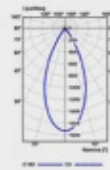

55°

Option	Color T°	CRI	Power	Lumen Output	Beam Angle
0335 / 0337 / 0338	2700K	90	7W 350mA	355lm / 387lm / 406lm / 313lm	15° / 24° / 36° / 55°
		90	10W 500mA	504lm / 550lm / 577lm / 445lm	15° / 24° / 36° / 55°
0335 / 0337 / 0338	3000K	90	7W 350mA	366lm / 399lm / 419lm / 323lm	15° / 24° / 36° / 55°
		90	10W 500mA	520lm / 567lm / 595lm / 459lm	15° / 24° / 36° / 55°
0335 / 0337 / 0338	4000K	90	7W 350mA	377lm / 411lm / 432lm / 333lm	15° / 24° / 36° / 55°
		90	10W 500mA	535lm / 584lm / 613lm / 472lm	15° / 24° / 36° / 55°

TULIPA ASYMMETRIC

incl. DIM 50.000hs L80 / B10 MacAdam 3 220-240V 50 / 60Hz 650°C

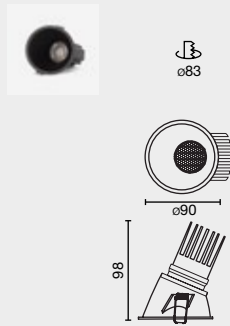

Family	Power	Color T°	Beam Angle	Finish	Control System
0336 Tulipa Asymmetric	1 7W 350mA	927 2700K CRI90	1 15°	1 White	W CASAMBI
	2 10W 500mA	930 3000K CRI90	2 24°	2 Black	D DALI
		940 4000K CRI90	3 36°		C TRAC
			5 55°		ON/OFF

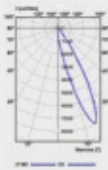

*15°

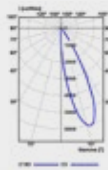

*24°

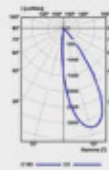

*36°

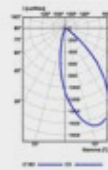

*55°

Option	Color T°	CRI	Power	Lumen Output	Beam Angle
0336	2700K	90	7W 350mA	333lm / 377lm / 465lm / 320lm	15° / 24° / 36° / 55°
		90	10W 500mA	472lm / 536lm / 660lm / 455lm	15° / 24° / 36° / 55°
0336	3000K	90	7W 350mA	343lm / 389lm / 479lm / 330lm	15° / 24° / 36° / 55°
		90	10W 500mA	487lm / 552lm / 680lm / 469lm	15° / 24° / 36° / 55°
0336	4000K	90	7W 350mA	353lm / 401lm / 493lm / 340lm	15° / 24° / 36° / 55°
		90	10W 500mA	502lm / 569lm / 701lm / 483lm	15° / 24° / 36° / 55°

*Beam angle with 30° inclination
*Ángulo con 30° inclinación

TULIPA ADJUSTABLE

NEW

incl. DIM 25° 50.000hs L80 / B10 MacAdam 3 220-240V 50 / 60Hz 650°C

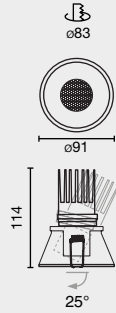

Family	Power	Color T°	Beam Angle	Finish	Control System
0339 Tulipa adjustable	1 7W 350mA	927 2700K CRI90	1 15°	1 White	W CASAMBI
	2 10W 500mA	930 3000K CRI90	2 24°	2 Black	D DALI
		940 4000K CRI90	3 36°		C TRAC
			5 55°		ON/OFF

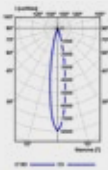

15°

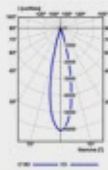

24°

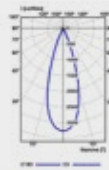

36°

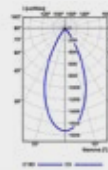

55°

Option	Color T°	CRI	Power	Lumen Output	Beam Angle
0339	2700K	90	7W 350mA	355lm / 387lm / 406lm / 313lm	15° / 24° / 36° / 55°
		90	10W 500mA	504lm / 550lm / 577lm / 445lm	15° / 24° / 36° / 55°
0339	3000K	90	7W 350mA	366lm / 399lm / 419lm / 323lm	15° / 24° / 36° / 55°
		90	10W 500mA	520lm / 567lm / 595lm / 459lm	15° / 24° / 36° / 55°
0339	4000K	90	7W 350mA	377lm / 411lm / 432lm / 333lm	15° / 24° / 36° / 55°
		90	10W 500mA	535lm / 584lm / 613lm / 472lm	15° / 24° / 36° / 55°





PODIUM is a modular system of recessed and surface light fixtures which offers different light effects and configurations, enabling the creation of different climates with an integrated aesthetic. One product, one project, infinite possibilities.

PODIUM es un sistema modular de luminarias de empotrar y de superficie que ofrece diferentes efectos lumínicos y configuraciones permitiendo generar diversos climas con una estética integrada. Un producto, un proyecto, infinitas posibilidades.

PODIUM



Podium Collection



Surface
299

MODULE
Modulo

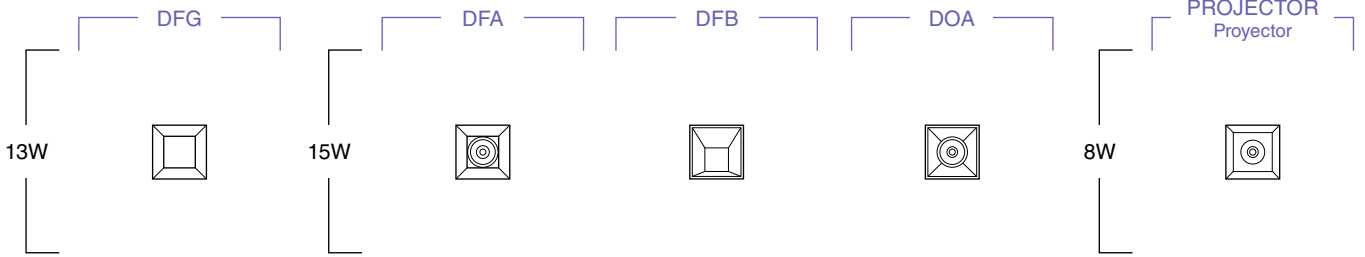

FRAME
Marco

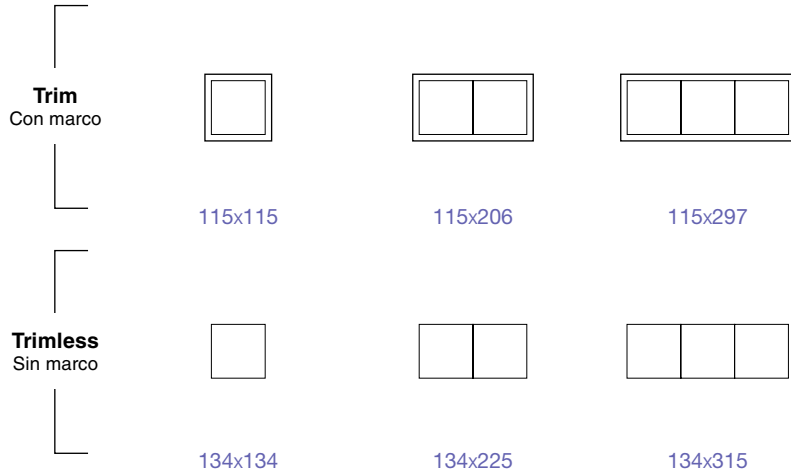

FINISH
Acabado



COLOR TEMPERATURE
Temperatura de color

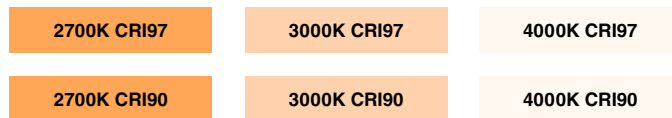

BEAM ANGLE
Ángulo de apertura



ACCESSORIES
Accesorios



CONTROL SYSTEM
Sistema de control



Highlights

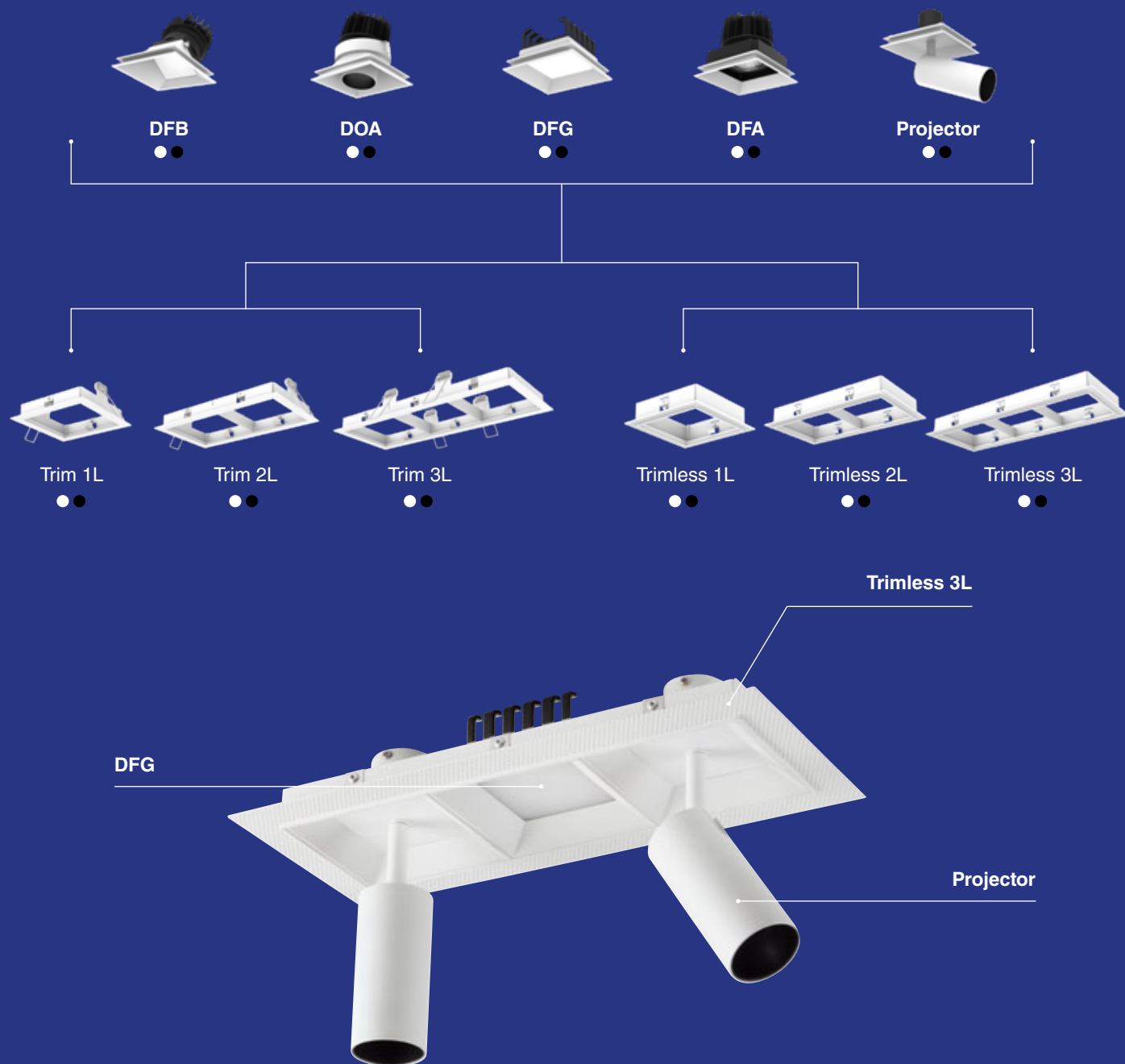

The recessed system has options with and without a frame of 1, 2 and 3 lights, making it possible to combine general, downlight, fixed and orientable accent and projector lighting optics into one product. The family is offered in 3 colour temperatures and high CRI.

El sistema empotrable cuenta con opciones con y sin marco de 1,2 y 3 luces pudiendo combinar en un mismo producto ópticas de iluminación general, bañador, acento fija y orientable y proyector. La familia se ofrece en 3 temperaturas de color y alto IRC.

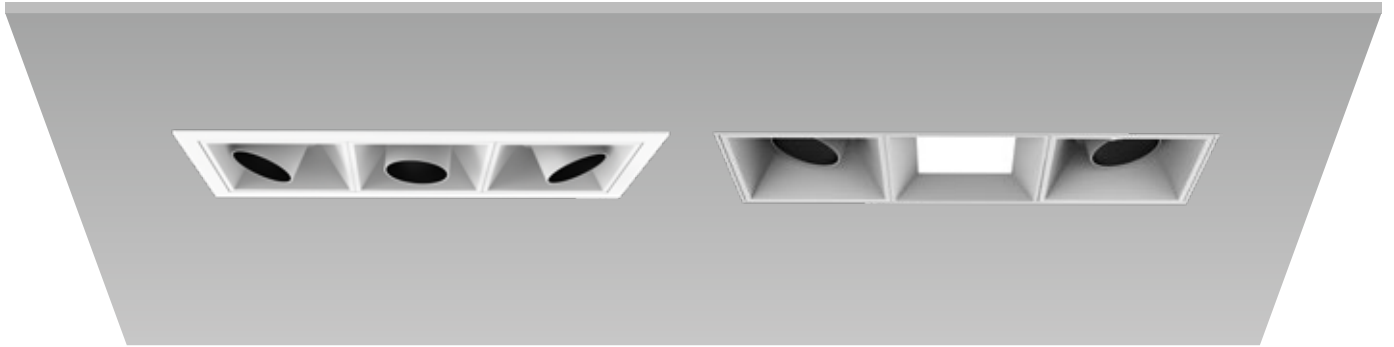



103x103

Trim 1L

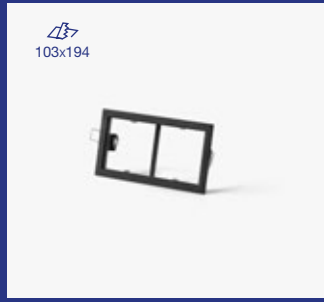
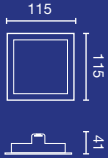

103x194

Trim 2L

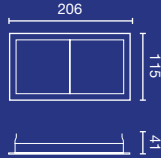

103x285

Trim 3L

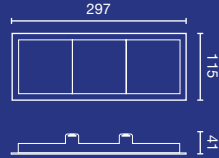

98x98

Trimless 1L

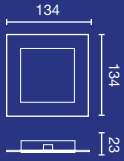

98x189

Trimless 2L

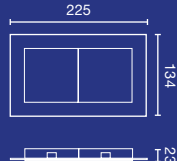

98x279

Trimless 3L

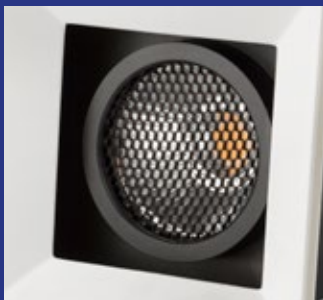
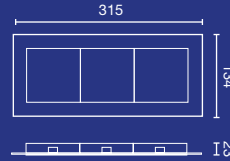

Honeycomb



Stripped Glass

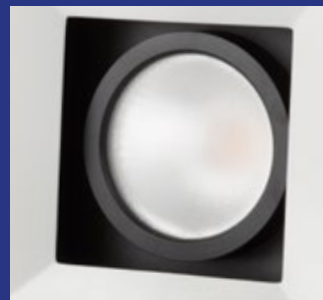

Diffusion Sheet

Frames

Accessories for DFA&DOA

Trim 1L	Trim 2L	Trim 3L	Trimless 1L	Trimless 2L	Trimless 3L
● 034100011	● 034100021	● 034100031	● 034200011	● 034200021	● 034200031
● 034100012	● 034100022	● 034100032	● 034200012	● 034200022	● 034200032

Honeycomb	Stripped Glass	Diffusion sheet
034100098	034100097	034100099



Residential



Restaurant

Beam Angle



15°

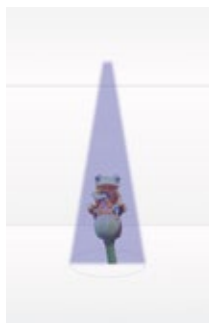

24/25°



35/38°



60°



90°

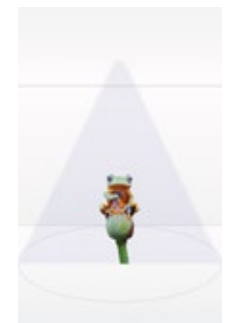

110°

PODIUM DFA MODULE

incl. DIM 50.000hs L70 / B10 MacAdam 3 220-240V 50 / 60Hz 650°C



Family	Color T°	Beam Angle	Finish	Control System
0341 Podium DFA Module 15W	927 2700K CRI97	1 15°	1 White	W CASAMBI
	930 3000K CRI97	2 24°	2 Black	D DALI
	940 4000K CRI97	3 38°		C TRAC
		6 60°		ON/OFF

0341 927 1 1 W

Example **034192711W** — Podium DFA 15W 2700K CRI97 15° White Casambi

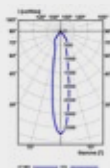

15°

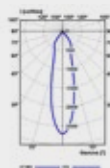

24°

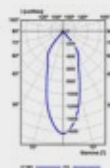

38°



60°

Option	Color T°	CRI	Power	Lumen Output	Beam Angle
X27	2700K	97	15W	957lm / 974lm / 794lm / 855lm	15° / 24° / 38° / 60°
X30	3000K	97	15W	987lm / 1004lm / 819lm / 881lm	15° / 24° / 38° / 60°
X40	4000K	97	15W	1017lm / 1034lm / 844lm / 907lm	15° / 24° / 38° / 60°

PODIUM DOA MODULE

incl. DIM 355° 20° 50.000hs L70 / B10 MacAdam 3 220-240V 50 / 60Hz 650°C

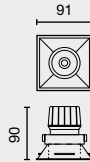

Family	Color T°	Beam Angle	Finish	Control System
0342 Podium DOA Module 15W	927 2700K CRI97	1 15°	1 White	W CASAMBI
	930 3000K CRI97	2 24°	2 Black	D DALI
	940 4000K CRI97	3 38°		C TRAC
		6 60°		ON/OFF

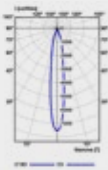

15°

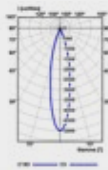

24°

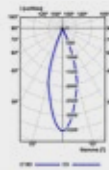

38°

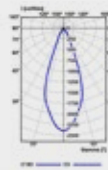

60°

Option	Color T°	CRI	Power	Lumen Output	Beam Angle
X27	2700K	97	15W	554lm / 534lm / 524lm / 493lm	15° / 24° / 38° / 60°
X30	3000K	97	15W	571lm / 551lm / 540lm / 508lm	15° / 24° / 38° / 60°
X40	4000K	97	15W	588lm / 568lm / 556lm / 523lm	15° / 24° / 38° / 60°

PODIUM DFB MODULE

incl. DIM 50.000hs L70 / B10 MacAdam 3 220-240V 50 / 60Hz 650°C

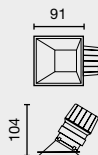

Family	Color T°	Beam Angle	Finish	Control System								
0344 Podium DFB Module 15W	927 2700K CRI97	9 90°	1 White	<table border="1"> <tr><td>W</td><td>CASAMBI</td></tr> <tr><td>D</td><td>DALI</td></tr> <tr><td>C</td><td>TRAC</td></tr> <tr><td></td><td>ON/OFF</td></tr> </table>	W	CASAMBI	D	DALI	C	TRAC		ON/OFF
	W		CASAMBI									
	D		DALI									
C	TRAC											
	ON/OFF											
930 3000K CRI97	2 Black											
940 4000K CRI97												

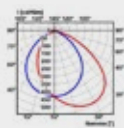

90°

Option	Color T°	CRI	Power	Lumen Output	Beam Angle
X27	2700K	97	15W	681lm	90°
X30	3000K	97	15W	702lm	90°
X40	4000K	97	15W	723lm	90°



PODIUM PROJECTOR MODULE

incl. DIM 355° 90° 50.000hs L70 / B10 MacAdam 3 220-240V 50 / 60Hz 650°C

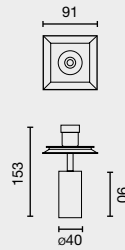

Family	Color T°	Beam Angle	Finish	Control System
0345 Podium Projector Module 8W	927 2700K CRI97	1 15°	1 White	W CASAMBI
	930 3000K CRI97	2 25°	2 Black	D DALI
	940 4000K CRI97			C TRAC ON/OFF

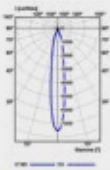

15°

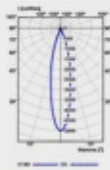

25°

Option	Color T°	CRI	Power	Lumen Output	Beam Angle
X27	2700K	97	8W	555lm / 524lm	15° / 25°
X30	3000K	97	8W	572lm / 540lm	15° / 25°
X40	4000K	97	8W	589lm / 573lm	15° / 25°

PODIUM DFG MODULE

incl. DIM 50.000hs L70 / B10 MacAdam 3 220-240V 50 / 60Hz 650°C



Family	Color T°	Beam Angle	Finish	Control System								
0343 Podium DFG Module 13W	927 2700K CRI90	0 110°	1 White	<table border="1"> <tr><td>W</td><td>CASAMBI</td></tr> <tr><td>D</td><td>DALI</td></tr> <tr><td>C</td><td>TRAC</td></tr> <tr><td></td><td>ON/OFF</td></tr> </table>	W	CASAMBI	D	DALI	C	TRAC		ON/OFF
	W		CASAMBI									
	D		DALI									
C	TRAC											
	ON/OFF											
930 3000K CRI90	2 Black											
940 4000K CRI90												

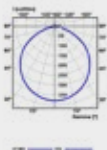

110°

Option	Color T°	CRI	Power	Lumen Output	Beam Angle
927	2700K	90	13W	427lm	110°
930	3000K	90	13W	440lm	110°
940	4000K	90	13W	453lm	110°

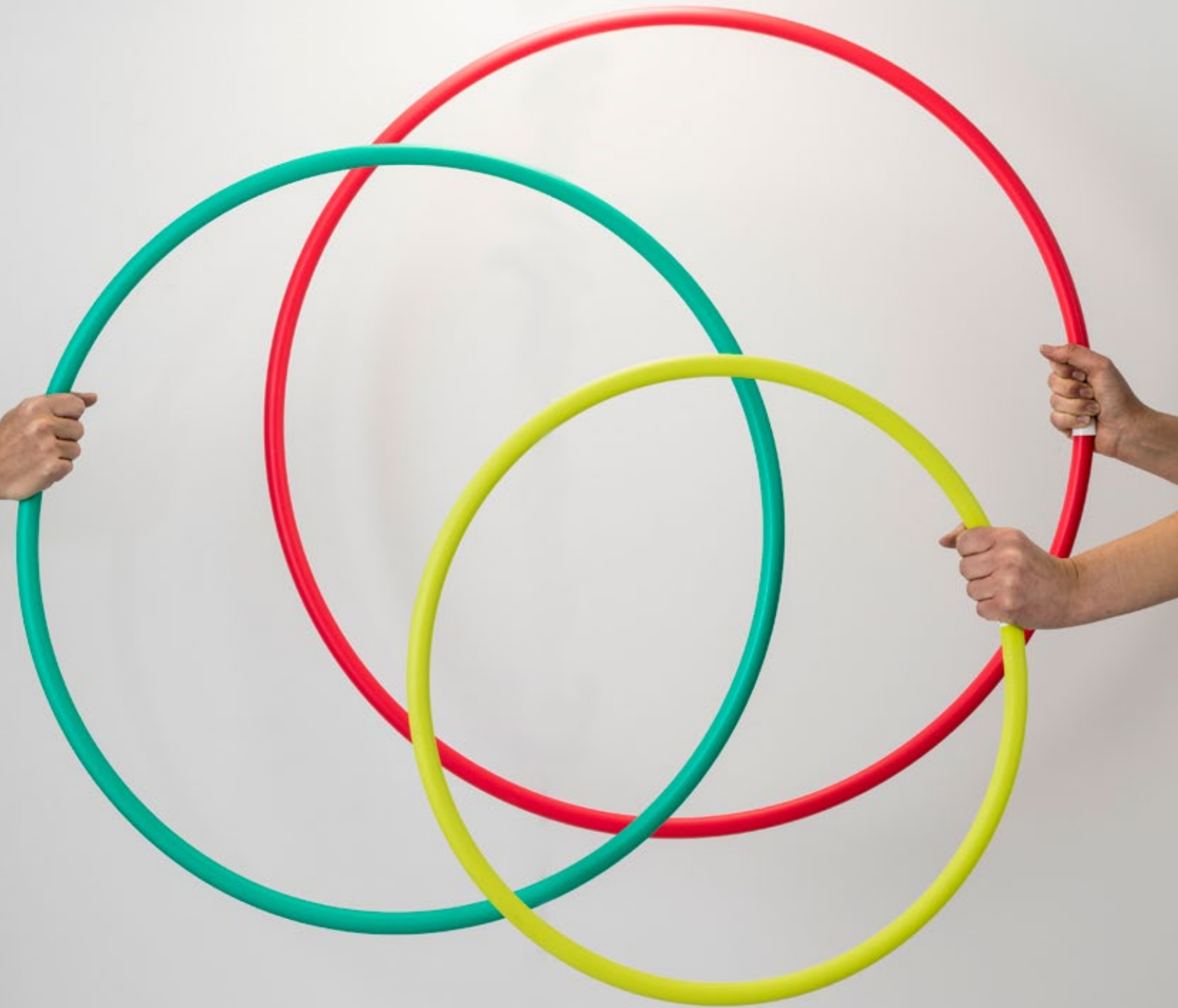

S U R F A C E

BLIT is a product with a minimalist design and a rectangular shape. Designed for surface installation on ceilings and walls, it provides indirect general lighting. Its elegant design seamlessly integrates into any environment, offering soft and ambient lighting that creates a cozy atmosphere. BLIT is the ideal choice for achieving discreet and effective lighting that enhances the aesthetics of the space.

BLIT es un producto de diseño minimalista y forma rectangular. Pensado para una instalación en superficie en techos y paredes, brinda una iluminación general de manera indirecta. Su diseño elegante se integra perfectamente en cualquier entorno, proporcionando una iluminación suave y ambiental que crea una atmósfera acogedora. BLIT es la elección ideal para lograr una iluminación discreta y efectiva que realza la estética del espacio.





BLIT

SURFACE



BLIT Collection



Track
59

Blit 210mm 20W **Blit 300mm** 33W



FINISH
Acabado

● **Black**
Negro

○ **White**
Blanco

COLOR TEMPERATURE
Temperatura de color

2700K CRI90

3000K CRI90

4000K CRI90

BEAM ANGLE
Ángulo de apertura



Asym

CONTROL SYSTEM
Sistema de control



Highlights

Available in two power options and made entirely of aluminum and glass, BLIT provides general illumination through indirect light. Its minimalist design with straight lines allows the luminaire to integrate perfectly into a wide range of spaces, whether installed on the wall or ceiling.

Disponible en dos opciones de potencia y fabricado íntegramente en aluminio y cristal, BLIT proporciona una iluminación general mediante luz indirecta. Su diseño minimalista de líneas rectas permite que la luminaria se integre perfectamente en una amplia gama de espacios, ya sea instalada en la pared o en el techo.

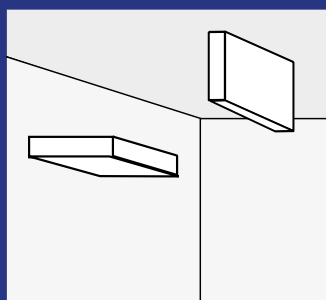

Wall & ceiling
Pared y techo



High CRI
Alto IRC



Several color temperatures
Varias temperaturas de color



Restaurant



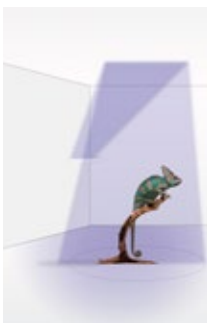

Home

Beam Angle

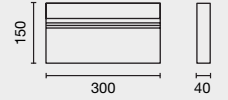
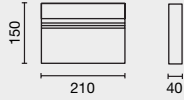

Asym°



Family	Color T°	Beam Angle	Finish	Control System
0125 Blit 210mm 20w	927 2700K CRI90	9 Asym	1 White	D 
0126 Blit 300mm 33w	930 3000K CRI90		2 Black	W 
	940 4000K CRI90			ON/OFF

0125 **927** **9** **1** **D**

Example **012592791D** — Blit 210mm 20W 2700K CRI90 White Dali

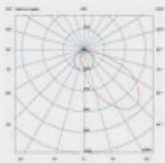

Asym

Option	Color T°	CRI	Power	Lumen Output	Beam Angle
927	2700K	90	20W	1633lm	Asym
		90	33W	3412lm	Asym
930	3000K	90	20W	1684lm	Asym
		90	33W	3517lm	Asym
940	4000K	90	20W	1734lm	Asym
		90	33W	3623lm	Asym



The SCUBA UGR luminaire is a versatile and watertight solution suitable for surface or suspension installation. It provides high-quality lighting with a Unified Glare Rating (UGR) of less than 16, making it perfect for office environments. Its industrial style adds a touch of modernity and uniqueness to any workspace while providing efficient and comfortable lighting. It is the ideal choice for creating office environments with an industrial aesthetic and optimal lighting.

La luminaria SCUBA UGR es una solución versátil y estanca, adecuada para su instalación en superficie o suspensión. Brinda una iluminación de alta calidad con un valor UGR (Deslumbramiento Unificado) menor a 16, lo que la hace perfecta para entornos de oficina. Su estilo industrial añade un toque de modernidad y singularidad a cualquier espacio de trabajo, a la vez que proporciona una iluminación eficiente y confortable. Es la elección ideal para crear ambientes de oficina con una estética industrial y una iluminación óptima.



SCUBA



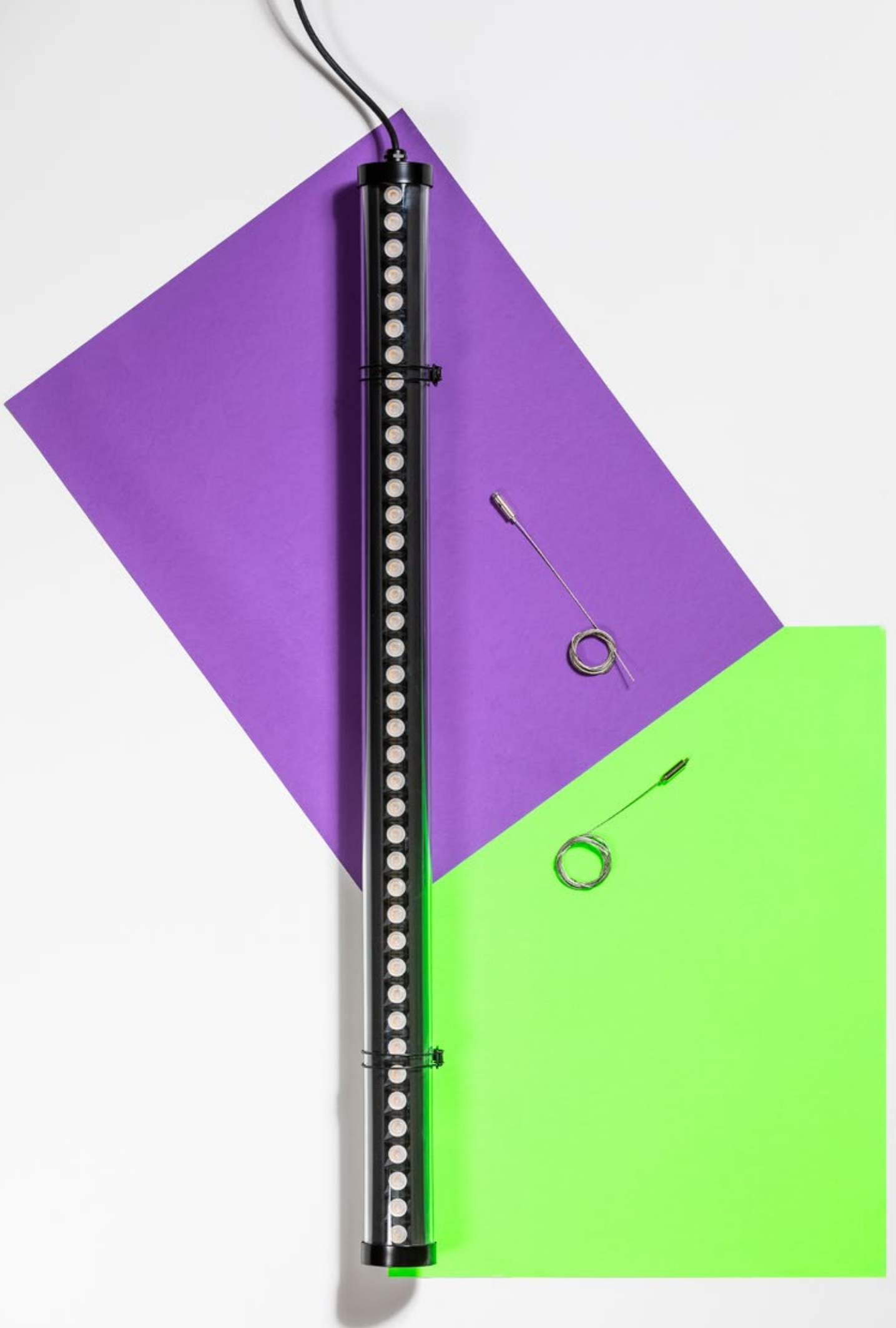

Scuba 1200mm
36W

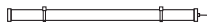

FINISH
Acabado

● **Black**
Negro

COLOR TEMPERATURE
Temperatura de color

3000K

4000K

ACCESSORIES
Accesorios



Suspended

CONTROL SYSTEM
Sistema de control



CASAMBI

Highlights

With a low UGR glare index, this linear luminaire becomes the ideal choice for both office environments and industrial spaces requiring a high IP rating. In addition, its remarkable impact resistance ensures reliable performance even in demanding work environments. With these features, the luminaire not only provides quality lighting but also ensures long-term durability and safety in various work settings.

Con un bajo índice de deslumbramiento UGR, esta luminaria lineal se convierte en la elección ideal tanto para entornos de oficina como para espacios industriales que requieran una clasificación de protección IP alta. Además, su notable resistencia al impacto garantiza un rendimiento confiable incluso en entornos de trabajo exigentes. Con estas características, la luminaria no solo proporciona una iluminación de calidad, sino que también asegura durabilidad y seguridad a largo plazo en diversos entornos laborales.

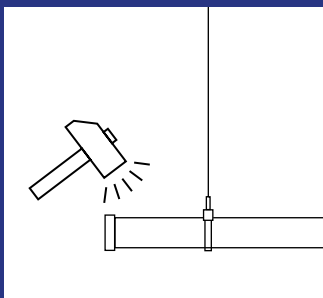

IK10

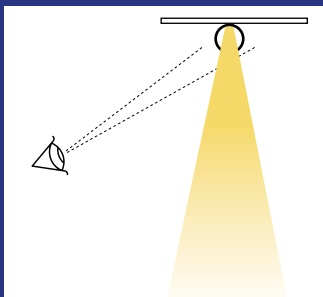

UGR < 19



Suspended option
Opción colgante



IP65



High CRI
Alto IRC





Suspended

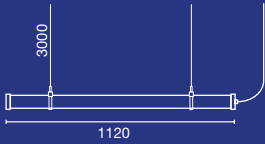

Accessories

Suspended

● 042500099



Office

Beam Angle

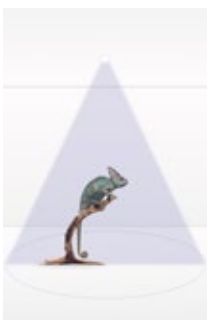

50°

SCUBA UGR 36W



incl. DIM 50.000hs L80 / B10 MacAdam 3 IP65 220-240V 50 / 60Hz 650°C

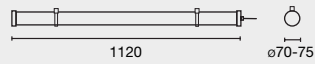

Family	Color T°	Beam Angle	Finish	Control System
0425 Scuba UGR 36W	930 3000K CRI90	5 50°	2 Black	W CASAMBI
	940 4000K CRI90			D BALI
				ON/OFF

0425 930 5 2 W

Example **042593052W** — Scuba UGR 36W 3000K CRI90 50° Black Casambi

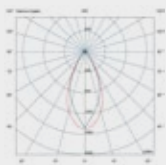

60°

Option	Color T°	CRI	Power	Lumen Output	Beam Angle
930	3000K	80	36W	2889	50°
940	4000K	80	36W	2976	50°





PROOFLINE is a rugged and high-performance linear luminaire designed for demanding environments. With an IP67 rating, it offers exceptional resistance to water and dust, making it ideal for applications in parking lots and industrial spaces where durability and reliability are crucial. Thanks to its high luminous efficiency up to 150lm/w, it provides efficient and bright lighting while reducing energy consumption. It is an ideal solution for challenging environments that require durable and efficient lighting.

PROOFLINE es una luminaria lineal resistente y de alto rendimiento diseñada para entornos exigentes. Con clasificación IP67, ofrece una excepcional resistencia al agua y al polvo, lo que la hace ideal para aplicaciones en estacionamientos y espacios industriales donde la durabilidad y la fiabilidad son fundamentales. Gracias a su alta eficiencia lumínica de hasta 150lm/w, proporciona una iluminación eficiente y brillante a la vez que reduce el consumo energético. Es una solución ideal para entornos desafiantes que requieren de una iluminación duradera y eficiente.

PROOF LINE





Proofline

[27 - 33 - 39 - 45W]



FINISH

Acabado



White
Blanco

COLOR TEMPERATURE

Temperatura de color

3000K CRI80

4000K CRI80

CONTROL SYSTEM

Sistema de control



CASAMBI

Highlights

Its high efficiency makes this luminaire the ideal option for extensive spaces that demand constant illumination, such as parking lots. Its impact resistance ensures exceptional durability, ensuring flawless operation, providing reliable and long-lasting lighting over time.

Su alta eficiencia convierte a esta luminaria en la opción ideal para espacios extensos que demandan iluminación constante, como por ejemplo, parkings. Su resistencia al impacto garantiza una durabilidad excepcional, lo que asegura un funcionamiento impecable, proporcionando una iluminación fiable y duradera a lo largo del tiempo.



IP65

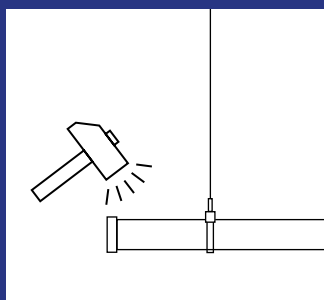

IK10

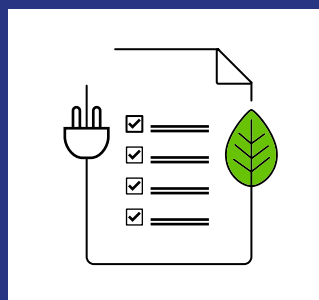

High Efficiency
Alta eficiencia

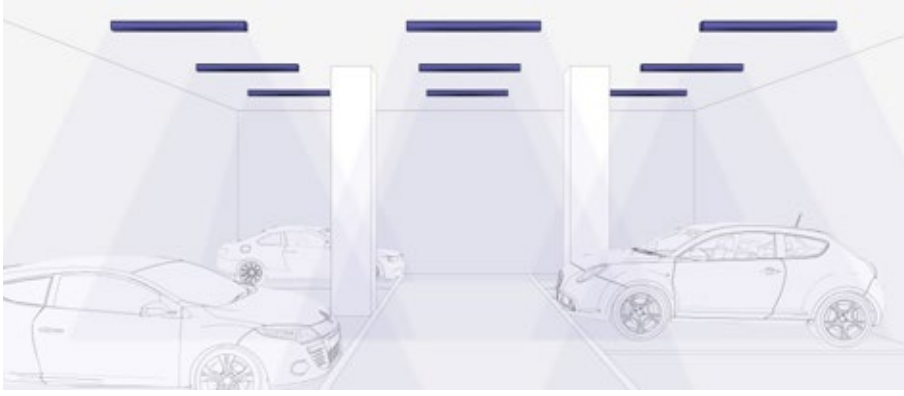

Parking

Beam Angle



120°

PROOFLINE 45W



incl. DIM 50.000hs L80 / B10 MacAdam 3 IP65 220-240V 50 / 60Hz 650°C

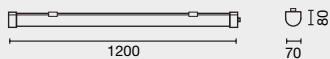

Family	Color T°	Beam Angle	Finish	Control System
0424 Proofline 45W	830 3000K CRI80 840 4000K CRI80	9 120°	1 White	D W ON/OFF

0424 **830** **9** **1** **D**

Example **042483091D** — Proofline 45W 3000K CRI80 120° White Dali

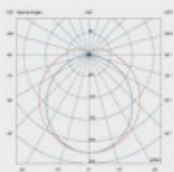

120°

Option	Color T°	CRI	Power	Lumen Output	Beam Angle
830	3000k	80	27W	3915lm	120°
840	4000k	80	27W	4032lm	120°
830	3000k	80	33W	4766lm	120°
840	4000k	80	33W	4908lm	120°
830	3000k	80	39W	5576lm	120°
840	4000k	80	39W	5743lm	120°
830	3000k	80	45W	6369lm	120°
840	4000k	80	45W	6914lm	120°

*Este producto integra un driver que permite cambiar la potencia de forma manual. Para realizar el cambio de potencia consultar el instructivo.
 *This product integrates a driver that allows manual adjustment of power. To change the power, please refer to the instructions.



FOST SURFACE meets the need to accentuate what needs to be highlighted. A minimalist design that is easy to integrate into any space, bringing the architecture to the forefront. It can be installed on both the vertical and horizontal plane without the need for a track.

FOST SURFACE da respuesta a la necesidad de poner acento a lo que debe ser destacado. Un diseño minimalista de fácil integración en cualquier espacio dando protagonismo a la arquitectura. Su instalación es posible tanto en el plano vertical como horizontal sin la necesidad de la utilización de carril.



F O S T



S U R F A C E



FOST Collection



Track
47



Recessed
171



Pulldown
181



Ceiling
277



Pendant
323

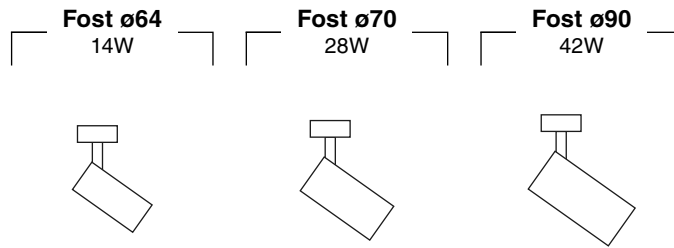

FINISH
Acabado

- Black**
Negro
- White**
Blanco

COLOR TEMPERATURE
Temperatura de color

2700K CRI90	3000K CRI90	4000K CRI90
2700K CRI97	3000K CRI97	4000K CRI97
MEAT	BREAD	FASHION

BEAM ANGLE
Ángulo de apertura



ACCESSORIES
Accesorios

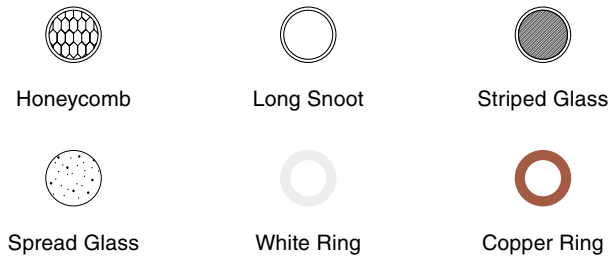

CONTROL SYSTEM
Sistema de control





White Ring



Copper Ring



Striped Glass

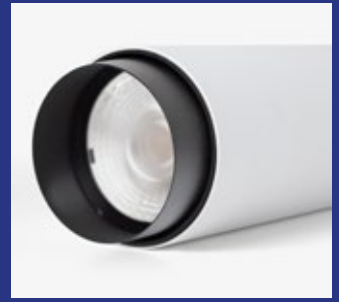

Long Snoot

Its multiple accessories and combinations facilitate the personalisation of the products, giving it certain architectural relevance and at the same time making it possible to modify the beam or reduce glare.

Sus múltiples accesorios y combinaciones facilitan la personalización del producto que hace posible la modificación de haz o reducir el deslumbramiento.

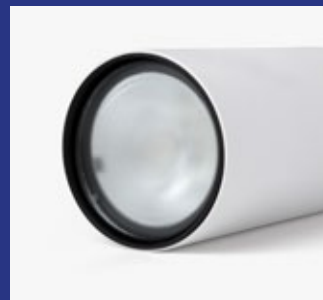

Spread Glass



Honeycomb



Without accessory



Spread Glass



Striped Glass

Accesorios

	Honeycomb	White Ring	Copper Ring	Spread Glass	Long Snoot	Striped Glass
ø64	011700094	011700099	011700098	011700097	011700095	011700096
ø70	011800094	011800099	011800098	011800097	011800095	011800096
ø90	012100094	012100099	012100098	012100097	012100095	012100096

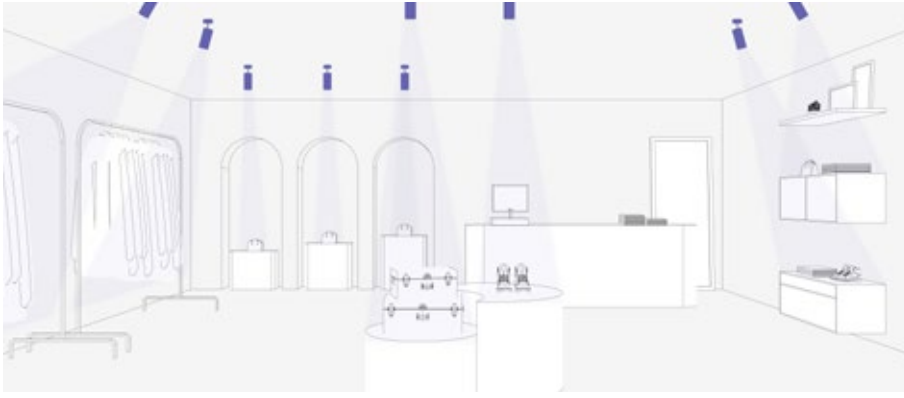

Retail



Restaurant

Beam Angle



17/18°



23/25°

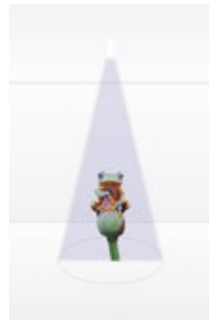

35/36/38°



60°

FOST SURFACE ø64

incl. 355° 90° 50.000hs L80 / B10 MacAdam 2&3 220-240V 50 / 60Hz 650°C

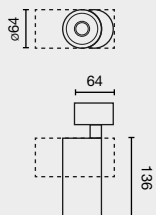

Family

Color T°

Beam Angle

Finish

0119 Fost surface ø64 14W

- 927** 2700K CRI90
- 930** 3000K CRI90
- 940** 4000K CRI90
- X27** 2700K CRI97
- X30** 3000K CRI97
- X40** 4000K CRI97

- 1** 17°
- 2** 25°
- 3** 35°
- N** **6** 60°

- 1** White
- 2** Black

0119

927

1

1

Example **011992711** — Fost Surface ø64 14W 2700K CRI90 17° White

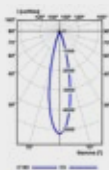

17°

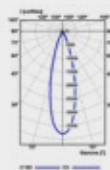

25°

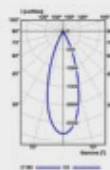

35°

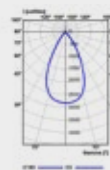

60°

Option	Color T°	CRI	Power	Lumen Output	Beam Angle
927	2700K	90	14W	950lm / 1076lm / 1127lm / 1248lm	17° / 25° / 35° / 60°
X27		97	14W	855lm / 968lm / 1014lm / 1123lm	17° / 25° / 35° / 60°
930	3000K	90	14W	979lm / 1109lm / 1162lm / 1287lm	17° / 25° / 35° / 60°
X30		97	14W	881lm / 998lm / 1046lm / 1159lm	17° / 25° / 35° / 60°
940	4000K	90	14W	1008lm / 1142lm / 1197lm / 1326lm	17° / 25° / 35° / 60°
X40		97	14W	908lm / 1028lm / 1077lm / 1193lm	17° / 25° / 35° / 60°

FOST SURFACE $\phi 70$

incl. DIM 355° 90° 50.000hs L80 / B10 MacAdam 2&3 220-240V 50 / 60Hz 650°C

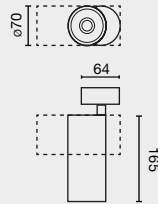

Family	Color T°	Beam Angle	Finish	Control System																
0120 Fost surface $\phi 70$ 28W	927 2700K CRI90	<table border="1"> <tr><td>1</td><td>18°</td></tr> <tr><td>2</td><td>23°</td></tr> <tr><td>3</td><td>36°</td></tr> <tr><td>6</td><td>60°</td></tr> </table>	1	18°	2	23°	3	36°	6	60°	<table border="1"> <tr><td>1</td><td>White</td></tr> <tr><td>2</td><td>Black</td></tr> </table>	1	White	2	Black	<table border="1"> <tr><td>C</td><td></td></tr> <tr><td></td><td>ON/OFF</td></tr> </table>	C			ON/OFF
	1		18°																	
	2		23°																	
	3		36°																	
	6	60°																		
	1	White																		
	2	Black																		
C																				
	ON/OFF																			
930 3000K CRI90	N																			
940 4000K CRI90																				
X27 2700K CRI97																				
X30 3000K CRI97																				
X40 4000K CRI97																				

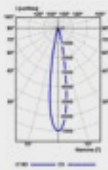

18°

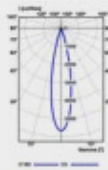

23°

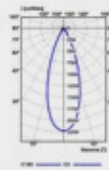

36°

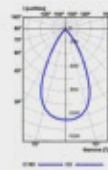

60°

Option	Color T°	CRI	Power	Lumen Output	Beam Angle
927	2700K	90	28W	2982lm / 2987lm / 2732lm / 2436lm	18° / 23° / 36° / 60°
X27		97	28W	2684lm / 2688lm / 2459lm / 2193lm	18° / 23° / 36° / 60°
930	3000K	90	28W	3075lm / 3080lm / 2817lm / 2512lm	18° / 23° / 36° / 60°
X30		97	28W	2767lm / 2771lm / 2535lm / 2261lm	18° / 23° / 36° / 60°
940	4000K	90	28W	3167lm / 3172lm / 2902lm / 2588lm	18° / 23° / 36° / 60°
X40		97	28W	2850lm / 2855lm / 2611lm / 2328lm	18° / 23° / 36° / 60°

FOST SURFACE ø90

incl. DIM 355° 90° 50.000hs L80 / B10 MacAdam 2&3 220-240V 50 / 60Hz 650°C

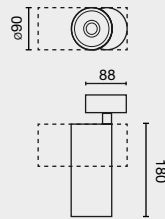

Family	Color T°	Beam Angle	Finish	Control System
0121 Fost surface ø90 42W	927 2700K CRI90	1 18° 2 23° 3 38°	1 White	D DALI C TRAC ON/OFF
	930 3000K CRI90		2 Black	
	940 4000K CRI90			
	X27 2700K CRI97			
	X30 3000K CRI97			
	X40 4000K CRI97			
	MT MEAT			
	BR BREAD			
	FS FASHION			

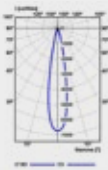

18°

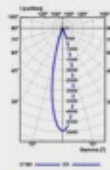

23°

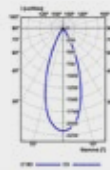

38°

Option	Color T°	CRI	Power	Lumen Output	Beam Angle
927	2700K	90	42W	3374lm / 3656lm / 3856lm	18° / 23° / 38°
X27	2700K	97	42W	3036lm / 3290lm / 3470lm	18° / 23° / 38°
930	3000K	90	42W	3478lm / 3769lm / 3975lm	18° / 23° / 38°
X30	3000K	97	42W	3130lm / 3392lm / 3577lm	18° / 23° / 38°
940	4000K	90	42W	3582lm / 3882lm / 4094lm	18° / 23° / 38°
X40	4000K	97	42W	3224lm / 3493lm / 3684lm	18° / 23° / 38°
MT	3100K	-	42W	2468lm / 2688lm / 2819lm	18° / 23° / 38°
BR	2500K	-	42W	3330lm / 3627lm / 3803lm	18° / 23° / 38°
FS	3100K	-	42W	3418lm / 3723lm / 3903lm	18° / 23° / 38°



Surface light fixture suitable for ceilings which do not offer recessed mounting. The versatility of sizes and optics of FOST CEILING makes it a perfect fixed overhead application solution for commercial spaces, hotels, restaurants, retail and even domestic spaces due to its various colour temperature and CRI options.

Luminaria de superficie indicada para techos sin posibilidad de empotramiento. La versatilidad de tamaños y ópticas de FOST CEILING lo convierten en una solución perfecta de aplicación fija cenital para espacios comerciales, hoteles, restauración, retail e incluso espacios domésticos por sus varias opciones en temperatura de color y IRC.



F O O S T



C E I L I N G



FOST Collection



Track
47



Recessed
171



Pulldown
181



Surface
267



Pendant
323

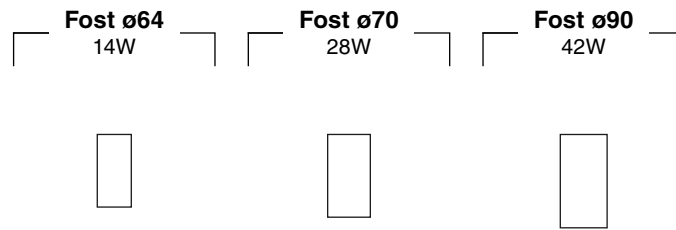

FINISH
Acabado

- Black**
Negro
 White
Blanco

COLOR TEMPERATURE
Temperatura de color

2700K CRI90	3000K CRI90	4000K CRI90
2700K CRI97	3000K CRI97	4000K CRI97
MEAT	BREAD	FASHION

BEAM ANGLE
Ángulo de apertura

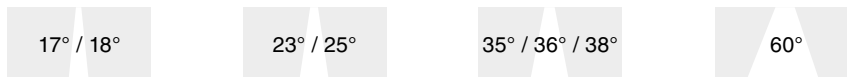

ACCESSORIES
Accesorios

- | | | |
|-----------------------------------------------------------------------------------------------------|---------------------------------------------------------------------------------------------------|--------------------------------------------------------------------------------------------------------|
| 
Honeycomb | 
Long Snoot | 
Striped Glass |
| 
Spread Glass | 
White Ring | 
Copper Ring |

CONTROL SYSTEM
Sistema de control





White Ring



Copper Ring



Striped Glass



Long Snoot

Its multiple accessories and combinations facilitate the product's personalisation, giving it certain architectural relevance and at the same time making it possible to modify the beam or reduce glare.

Sus múltiples accesorios y combinaciones facilitan la personalización del producto, que hace posible la modificación de haz o reducir el deslumbramiento.



Spread Glass

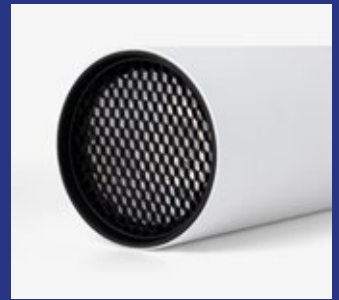

Honeycomb



Without accessory



Spread Glass



Striped Glass

Accesorios

	Honeycomb	White Ring	Copper Ring	Spread Glass	Long Snoot	Striped Glass
ø64	011700094	011700099	011700098	011700097	011700095	011700096
ø70	011800094	011800099	011800098	011800097	011800095	011800096
ø90	012100094	012100099	012100098	012100097	012100095	012100096



Retail



Restaurant

Beam Angle



17/18°



23/25°

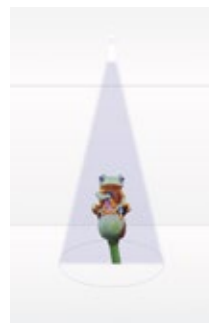

35/36/38°



60°

FOST CEILING ø64

incl. 50.000hs L80 / B10 MacAdam 2&3 220-240V 50 / 60Hz 650°C

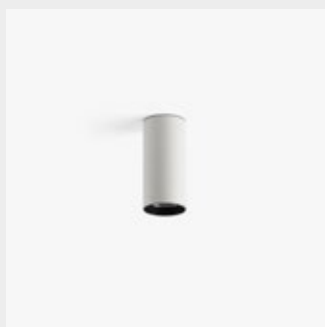

Family	Color T°	Beam Angle	Finish													
0510 Fost ceiling ø64 14W	927 2700K CRI90	<table border="1"> <tr><td>1</td><td>17°</td></tr> <tr><td>2</td><td>25°</td></tr> <tr><td>3</td><td>35°</td></tr> <tr><td>N</td><td>6</td><td>60°</td></tr> </table>	1	17°	2	25°	3	35°	N	6	60°	<table border="1"> <tr><td>1</td><td>White</td></tr> <tr><td>2</td><td>Black</td></tr> </table>	1	White	2	Black
	1		17°													
	2		25°													
	3		35°													
	N		6	60°												
	1		White													
	2		Black													
930 3000K CRI90																
940 4000K CRI90																
X27 2700K CRI97																
X30 3000K CRI97																
X40 4000K CRI97																

0510 927 1 1

Example **051092711** — Fost Ceiling ø64 14W 2700K CRI90 17° White

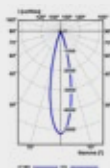

17°

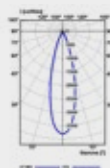

25°

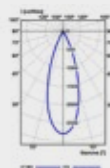

35°

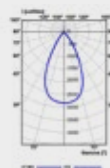

60°

Option	Color T°	CRI	Power	Lumen Output	Beam Angle
927	2700K	90	14W	950lm / 1076lm / 1127lm / 1248lm	17° / 25° / 35° / 60°
X27		97	14W	855lm / 1968lm / 1014lm / 1123lm	17° / 25° / 35° / 60°
930	3000K	90	14W	979lm / 1109lm / 1162lm / 1287lm	17° / 25° / 35° / 60°
X30		97	14W	881lm / 998lm / 1046lm / 1159lm	17° / 25° / 35° / 60°
940	4000K	90	14W	1008lm / 1142lm / 1197lm / 1326lm	17° / 25° / 35° / 60°
X40		97	14W	908lm / 1028lm / 1077lm / 1193lm	17° / 25° / 35° / 60°

FOST CEILING ø70

incl. 50.000hs L80 / B10 MacAdam 2&3 220-240V 50 / 60Hz 650°C

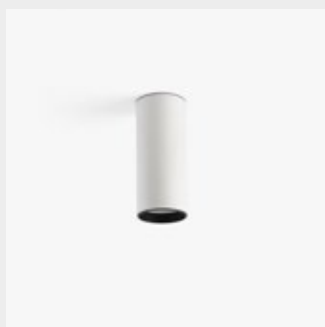

Family	Color T°	Beam Angle	Finish	Control System																
0511 Fost ceiling ø70 28W	927 2700K CRI90	<table border="1"> <tr><td>1</td><td>18°</td></tr> <tr><td>2</td><td>23°</td></tr> <tr><td>3</td><td>36°</td></tr> <tr><td>6</td><td>60°</td></tr> </table>	1	18°	2	23°	3	36°	6	60°	<table border="1"> <tr><td>1</td><td>White</td></tr> <tr><td>2</td><td>Black</td></tr> </table>	1	White	2	Black	<table border="1"> <tr><td>C</td><td></td></tr> <tr><td></td><td>ON/OFF</td></tr> </table>	C			ON/OFF
	1		18°																	
	2		23°																	
	3		36°																	
	6	60°																		
	1	White																		
	2	Black																		
C																				
	ON/OFF																			
930 3000K CRI90	N																			
940 4000K CRI90																				
X27 2700K CRI97																				
X30 3000K CRI97																				
X40 4000K CRI97																				

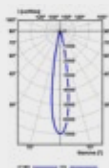

18°

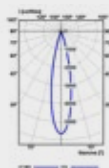

23°

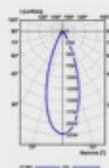

36°

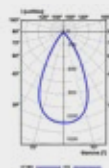

60°

Option	Color T°	CRI	Power	Lumen Output	Beam Angle
927	2700K	90	28W	2982lm / 2987lm / 2732lm / 2436lm	18° / 23° / 36° / 60°
X27		97	28W	2684lm / 2688lm / 2459lm / 2193lm	18° / 23° / 36° / 60°
930	3000K	90	28W	3075lm / 3080lm / 2817lm / 2512lm	18° / 23° / 36° / 60°
X30		97	28W	2767lm / 2771lm / 2535lm / 2261lm	18° / 23° / 36° / 60°
940	4000K	90	28W	3167lm / 3172lm / 2902lm / 2588lm	18° / 23° / 36° / 60°
X40		97	28W	2850lm / 2855lm / 2611lm / 2328lm	18° / 23° / 36° / 60°

FOST CEILING ø90

incl. DIM 50.000hs L80 / B10 MacAdam 2&3 220-240V 50 / 60Hz 650°C



Family	Color T°	Beam Angle	Finish	Control System
0512 Fost ceiling ø90 42W	927 2700K CRI90	1 18° 2 23° 3 38°	1 White	D DALI
	930 3000K CRI90		2 Black	C TRAC
	940 4000K CRI90			ON/OFF
	X27 2700K CRI97			
	X30 3000K CRI97			
	X40 4000K CRI97			
	MT MEAT			
	BR BREAD			
	FS FASHION			

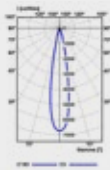

18°

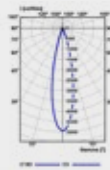

23°

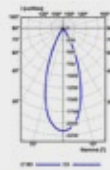

38°

Option	Color T°	CRI	Power	Lumen Output	Beam Angle
927	2700K	90	42W	3374lm / 3656lm / 3856lm	18° / 23° / 38°
X27	2700K	97	42W	3036lm / 3290lm / 3470lm	18° / 23° / 38°
930	3000K	90	42W	3478lm / 3769lm / 3975lm	18° / 23° / 38°
X30	3000K	97	42W	3130lm / 3392lm / 3577lm	18° / 23° / 38°
940	4000K	90	42W	3582lm / 3882lm / 4094lm	18° / 23° / 38°
X40	4000K	97	42W	3224lm / 3493lm / 3684lm	18° / 23° / 38°
MT	3100K	-	42W	2468lm / 2688lm / 2819lm	18° / 23° / 38°
BR	2500K	-	42W	3330lm / 3627lm / 3803lm	18° / 23° / 38°
FS	3100K	-	42W	3418lm / 3723lm / 3903lm	18° / 23° / 38°

Thanks to Bird Studio Render by Tekten



Need consulting
for your project?
¿Necesitas
asesoramiento
para tu proyecto?





DOMIO is a family of circular light fixtures with pure lines. Its different sizes and installation options make it an ideal solution for the lighting of big spaces like lobbies, conference rooms and restaurants. Its glare control options and tunable white make it a perfect option for work zones and spaces dedicated to healthcare.

DOMIO es una familia de luminarias circulares de líneas puras. Sus diferentes tamaños y opciones de instalación la convierten en una solución ideal para la iluminación de grandes espacios como vestíbulos, salas de conferencias y restaurantes. Sus opciones con el control del deslumbramiento y tunable white hacen que sea una opción perfecta para zonas de trabajo y espacios dedicados a la salud.



DOMIO



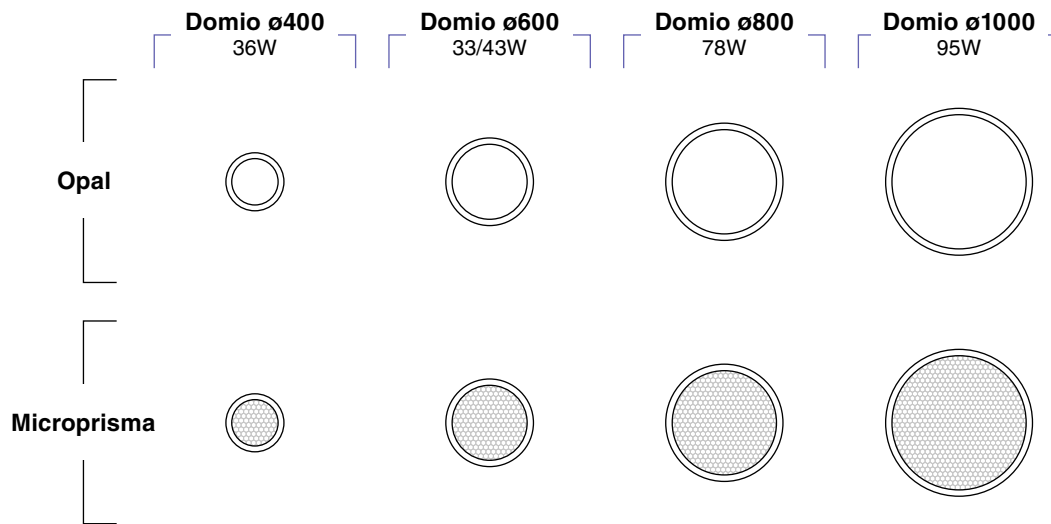

FINISH
Acabado

● **Black**
Negro

○ **White**
Blanco

COLOR TEMPERATURE
Temperatura de color

3000K

4000K

2700-6500K

ACCESSORIES
Accesorios



Suspended

CONTROL SYSTEM
Sistema de control



CASAMBI

Highlights

Available in 4 sizes of 400 mm, 600 mm, 800 mm and 1000 mm with two optics variants: opal high-transmittance PMMA to offer uniform and microprismatic general lighting for applications where glare control is required. Its UGR<19 make it an ideal option for office or continuous work applications.

Disponible en 4 tamaños de 400mm, 600mm, 800mm y 1000mm con dos variantes de ópticas: PMMA opal de alta transmitancia para ofrecer una iluminación general uniforme y micro prismática para aplicaciones donde el control de deslumbramiento es una necesidad. Su UGR<19 lo convierten en una opción ideal para aplicaciones de oficina o de trabajo en continuo.

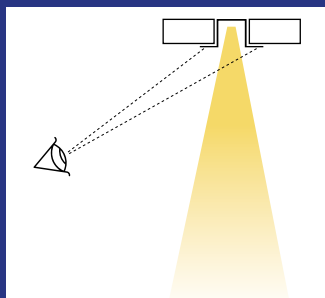
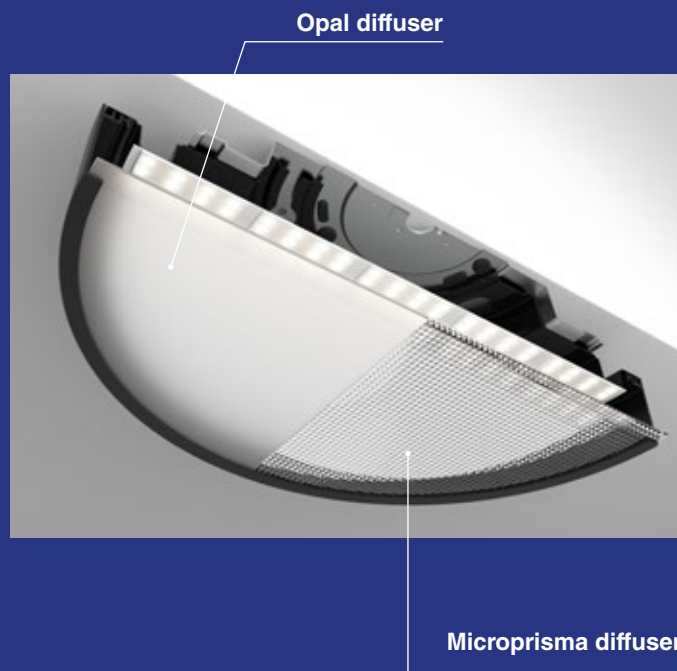

UGR<19



Different sizes
Diversos tamaños

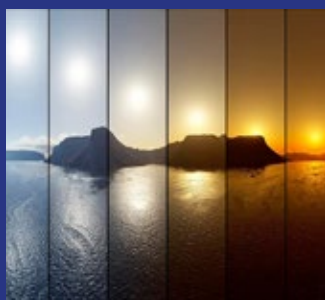

Tunable white



Semi Recessed option
Opción semi empotrado



Wall & ceiling
Aplique y plafón



Suspended option
Opción colgante





Suspended

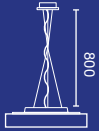

Accesories

Suspended

● 050000097

● 050000098



Office

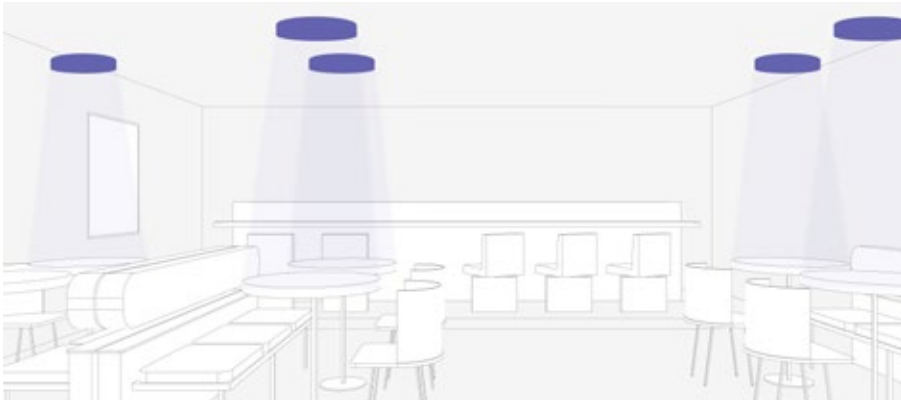

Restaurant

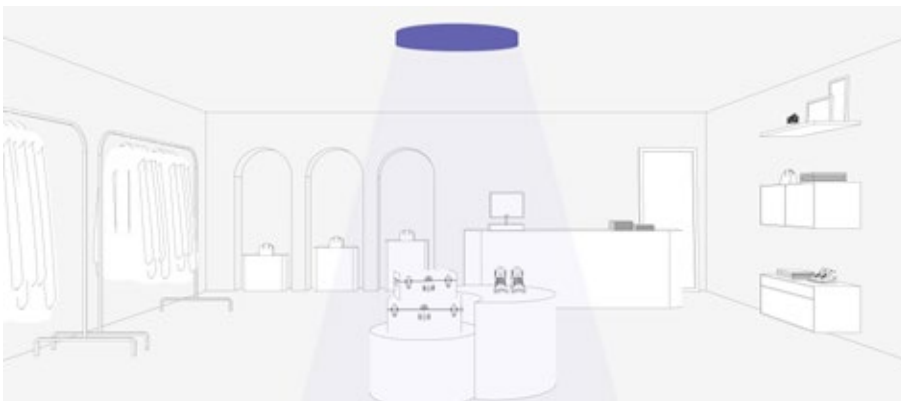

Retail

Beam Angle



90°

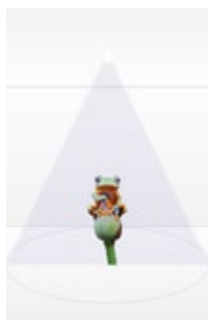

110°

DOMIO ø400 36W

incl. DIM 50.000hs L80 / B10 MacAdam 3 220-240V 50 / 60Hz 650°C UGR <19

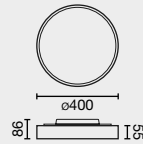
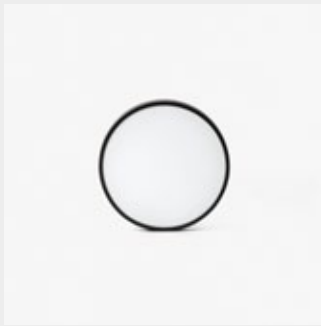

Family	Color T°	Diffuser	Finish	Control System
0414 Domio ø400 36W	830 3000K CRI80	1 Opal	1 White	W CASAMBI
	840 4000K CRI80	2 Microprisma	2 Black	D BALI ON/OFF

0414 830 1 1 W

Example **041483011W** — Domio ø400 36W 3000K Opal Diffusor White Casambi

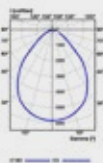

90°
microprisma

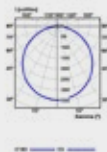

110°
opal

Option	Color T°	CRI	Power	Lumen Output	Diffuser
830	3000K	80	36W	3861lm	Opal
				3047lm	Microprisma
840	4000K	80	36W	3977lm	Opal
				3138lm	Microprisma

DOMIO ø600 43W

incl. DIM TW 50.000hs L80 / B10 MacAdam 3 220-240V 50 / 60Hz 650°C UGR <19

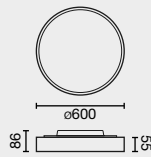
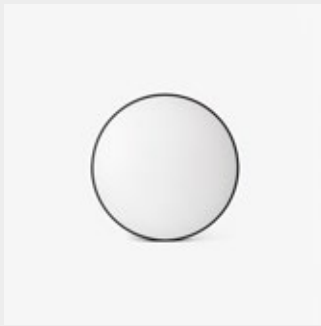

Family	Color T°	Diffuser	Finish	Control System
0415 Domio ø600 43W	830 3000K CRI80	1 Opal	1 White	W CASAMBI
	840 4000K CRI80	2 Microprisma	2 Black	D DALI ON/OFF
0419 Domio ø600 33W TW	TW 2700-6500K	1 Opal	1 White	W CASAMBI
		2 Microprisma	2 Black	D DALI

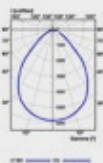

90°
microprisma



110°
opal

Option	Color T°	CRI	Power	Lumen Output	Diffuser
830	3000K	80	43W	4725lm	Opal
				4059lm	Microprisma
840	4000K	80	43W	4867lm	Opal
				4181lm	Microprisma

DOMIO ø600 TW					
TW	2700-6500K	-	33W	3528lm	Opal
TW	2700-6500K	-	33W	3031lm	Microprisma

DOMIO ø800 78W

incl. DIM 50.000hs L80 / B10 MacAdam 3 220-240V 50 / 60Hz 650°C UGR <19

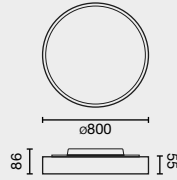
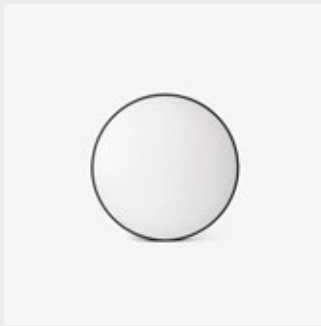

Family	Color T°	Diffuser	Finish	Control System
0416 Domio ø800 78W	830 3000K CRI80	1 Opal	1 White	W CASAMBI
	840 4000K CRI80	2 Microprisma	2 Black	D BALI ON/OFF

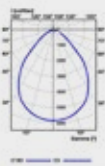

90°
microprisma

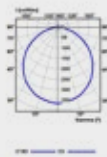

110°
opal

Option	Color T°	CRI	Power	Lumen Output	Diffuser
830	3000K	80	78W	8174lm	Opal
				7022lm	Microprisma
840	4000K	80	78W	8419lm	Opal
				7232lm	Microprisma

DOMIO ø1000 95W

incl. DIM 50.000hs L80 / B10 MacAdam 3 220-240V 50 / 60Hz 650°C UGR <19

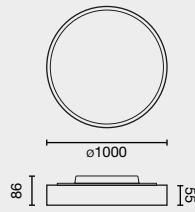

Family	Color T°	Diffuser	Finish	Control System
0417 Domio ø1000 95W	830 3000K CRI80	1 Opal	1 White	W CASAMBI
	840 4000K CRI80	2 Microprisma	2 Black	D BALI ON/OFF

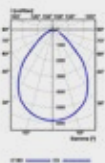

90°
microprisma



110°
opal

Option	Color T°	CRI	Power	Lumen Output	Diffuser
830	3000K	80	95W	10490lm	Opal
				9010lm	Microprisma
840	4000K	80	95W	10804lm	Opal
				9281lm	Microprisma

PODIUM is a modular system of recessed and surface light fixtures which offers different light effects and configurations, enabling the creation of different climates with an integrated aesthetic. One product, one project, infinite possibilities.

PODIUM es un sistema modular de luminarias de empotrar y de superficie que ofrece diferentes efectos lumínicos y configuraciones permitiendo generar diversos climas con una estética integrada. Un producto, un proyecto, infinitas posibilidades.





PODIUM



PODIUM Collection



Downlight
225

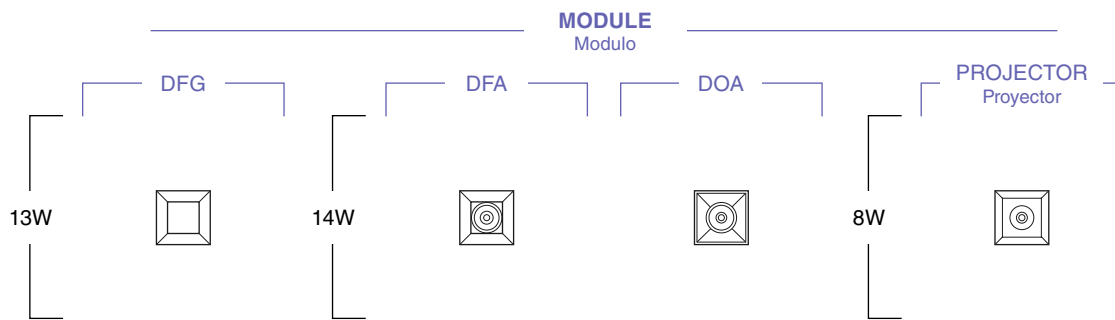

SURFACE BOX
Caja de superficie



108x108



108x206

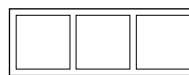

108x304

FINISH
Acabado



COLOR TEMPERATURE
Temperatura de color

2700K CRI97

3000K CRI97

4000K CRI97

2700K CRI90

3000K CRI90

4000K CRI90

BEAM ANGLE
Ángulo de apertura

18°

24 / 25°

35° / 38°

60°

90°

100°

ACCESSORIES
Accesorios



Honeycomb



Striped glass



Diffusion sheet

CONTROL SYSTEM
Sistema de control



CASAMBI



Highlights

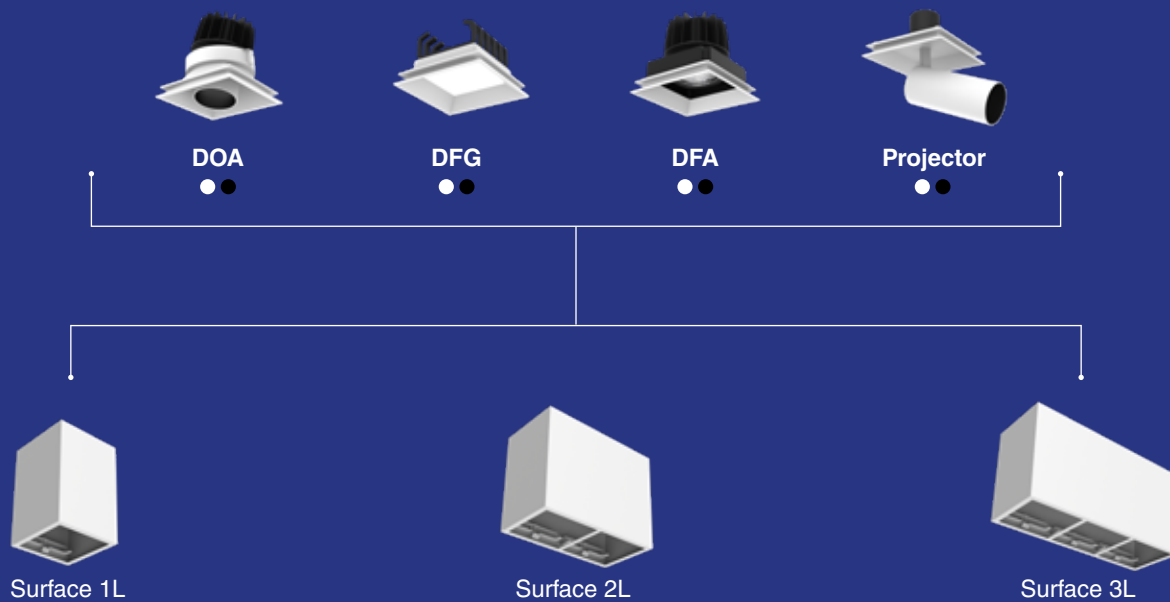





Surface box 1L

Surface box 2L

Surface box 3L

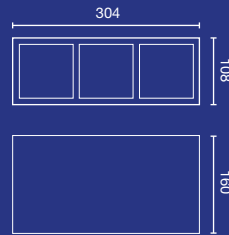
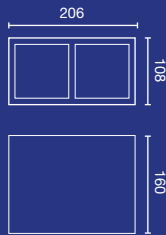
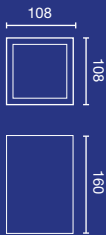

Honeycomb



Stripped Glass

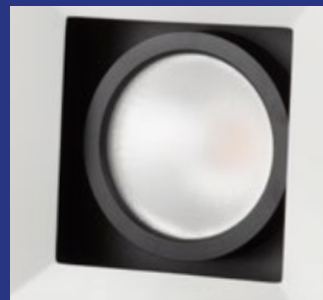

Diffusion Sheet

Surface box

Accessories for DFA&DOA

Surface box 1L	Surface box 2L	Surface box 3L
● 051300011	● 051400021	● 051500031
● 051300012	● 051400022	● 051500032

Honeycomb	Stripped Glass	Diffusion sheet
034100098	034100097	034100099



Residential



Restaurant

Beam Angle



18°

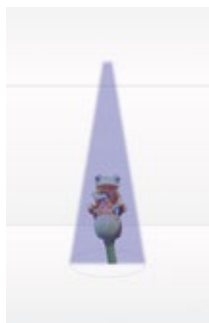

24/25°



35/38°



60°



90°

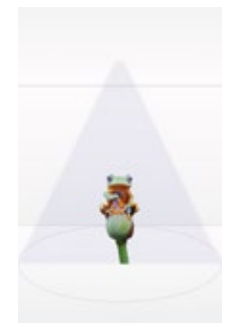

110°

PODIUM DFA MODULE

incl. DIM 50.000hs L70 / B10 MacAdam 3 220-240V 50 / 60Hz 650°C



Family	Color T°	Beam Angle	Finish	Control System
0341 Podium DFA Module 15W	927 2700K CRI97	1 15°	1 White	W CASAMBI
	930 3000K CRI97	2 24°	2 Black	D DALI
	940 4000K CRI97	3 38°		C TRAC
		6 60°		ON/OFF

0341 927 1 1 W

Example **034192711W** — Podium DFA Module 15W 2700K CRI97 15° White Casambi

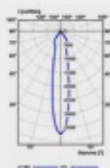

15°

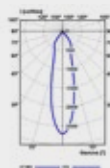

24°

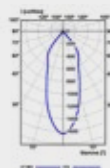

38°

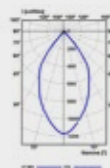

60°

Option	Color T°	CRI	Power	Lumen Output	Beam Angle
X27	2700K	97	15W	957lm / 974lm / 794lm / 855lm	15° / 24° / 38° / 60°
X30	3000K	97	15W	987lm / 1004lm / 819lm / 881lm	15° / 24° / 38° / 60°
X40	4000K	97	15W	1017lm / 1034lm / 844lm / 907lm	15° / 24° / 38° / 60°

See surface box options on page 304
Ver opciones de caja en página 304

PODIUM DOA MODULE

incl. DIM 355° 20° 50.000hs L70 / B10 MacAdam 3 220-240V 50 / 60Hz 650°C



Family	Color T°	Beam Angle	Finish	Control System
0342 Podium DOA Module 15W	927 2700K CRI97	1 15°	1 White	W CASAMBI
	930 3000K CRI97	2 24°	2 Black	D DALI
	940 4000K CRI97	3 38°		C TRAC
		6 60°		ON/OFF

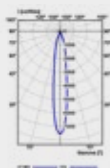

15°

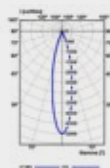

24°

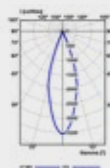

38°

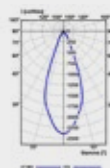

60°

Option	Color T°	CRI	Power	Lumen Output	Beam Angle
X27	2700K	97	15W	554lm / 534lm / 524lm / 493lm	15° / 24° / 38° / 60°
X30	3000K	97	15W	571lm / 551lm / 540lm / 508lm	15° / 24° / 38° / 60°
X40	4000K	97	15W	588lm / 568lm / 556lm / 523lm	15° / 24° / 38° / 60°

See surface box options on page 304
Ver opciones de caja en página 304

PODIUM DFG MODULE

incl. DIM 50.000hs L70 / B10 MacAdam 3 220-240V 50 / 60Hz 650°C

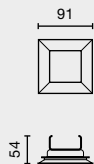

Family	Color T°	Beam Angle	Finish	Control System
0343 Podium DFG Module 13W	927 2700K CRI90	0 110°	1 White	W CASAMBI D DALI C TRAC ON/OFF
	930 3000K CRI90		2 Black	
	940 4000K CRI90			

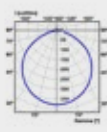

110°

Option	Color T°	CRI	Power	Lumen Output	Beam Angle
927	2700K	90	13W	427lm	110°
930	3000K	90	13W	440lm	110°
940	4000K	90	13W	453lm	110°

See surface box options on page 304
Ver opciones de caja en página 304

PODIUM PROJECTOR MODULE

incl. DIM 355° 90° 50.000hs L70 / B10 MacAdam 3 220-240V 50 / 60Hz 650°C

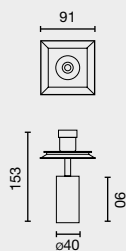

Family	Color T°	Beam Angle	Finish	Control System
0345 Podium Projector Module 8W	927 2700K CRI97	1 15°	1 White	W CASAMBI
	930 3000K CRI97	2 25°	2 Black	D DALI
	940 4000K CRI97			C TRAC ON/OFF

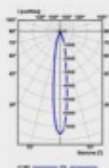

15°

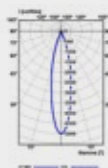

25°

Option	Color T°	CRI	Power	Lumen Output	Beam Angle
X27	2700K	97	8W	555lm / 524lm	15° / 25°
X30	3000K	97	8W	572lm / 540lm	15° / 25°
X40	4000K	97	8W	589lm / 573lm	15° / 25°

See surface box options on page 304
Ver opciones de caja en página 304



S U S P E N D E D

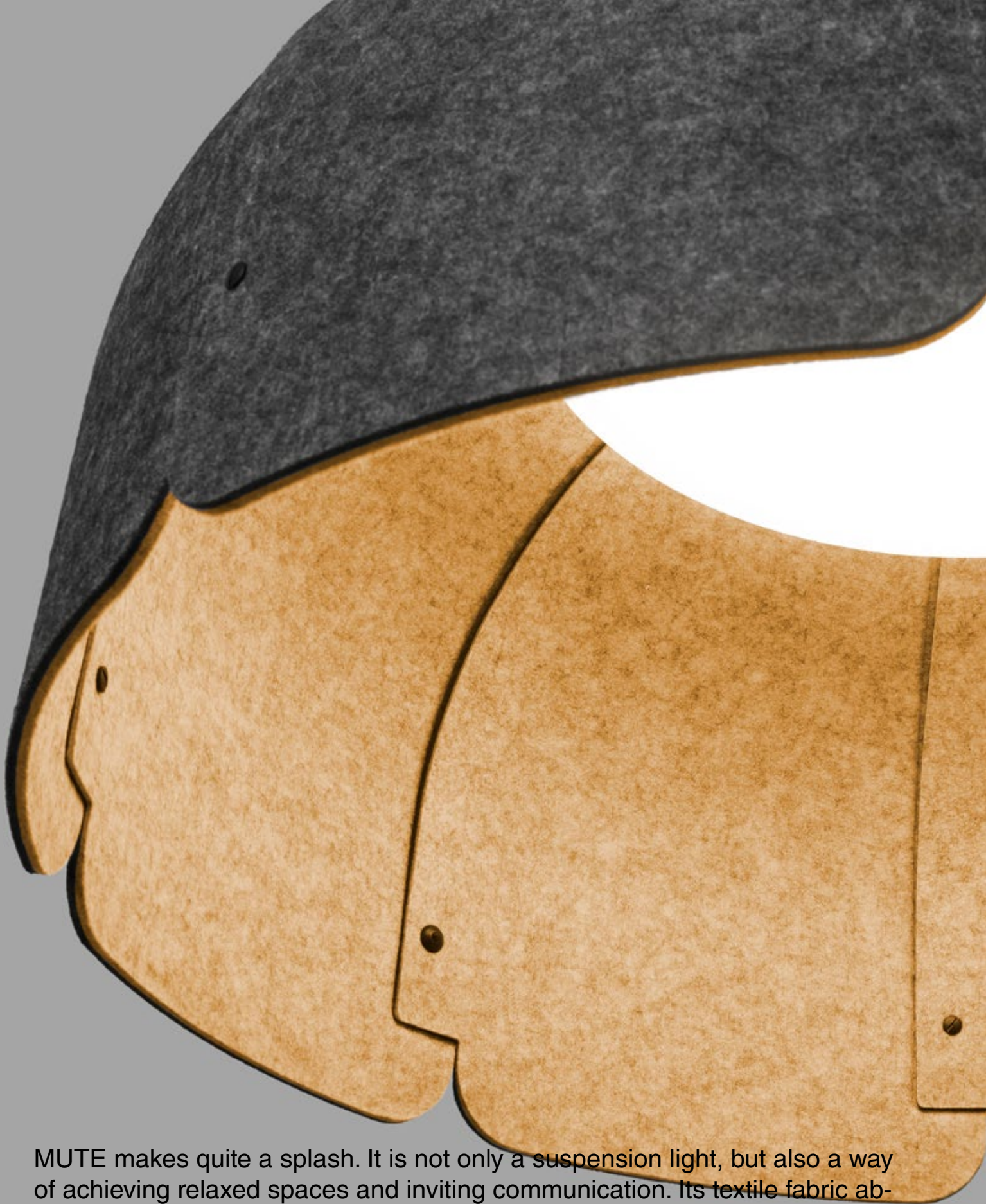

MUTE makes quite a splash. It is not only a suspension light, but also a way of achieving relaxed spaces and inviting communication. Its textile fabric absorbs reverberation and contributes to the reduction of environmental noise. MUTE no es sólo una luminaria de suspensión. Es la forma de conseguir espacios relajados y que inviten a la comunicación. Su tejido textil absorbe la reverberación y contribuye a la reducción del ruido ambiental.



MUTE

DESIGNED BY NAHTRANG



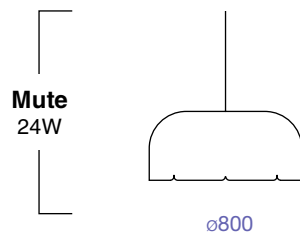

FINISH
Acabado

- **Dark Grey+Grey**
Gris oscuro+Gris
- **Dark Grey+Brown**
Gris oscuro+Marrón

COLOR TEMPERATURE
Temperatura de color

3000K CRI>80

4000K CRI>80

CONTROL SYSTEM
Sistema de control



Highlights

Recycled PET

Because polyester accounts for approximately 60 percent of the world's production of PET, developing a non-virgin supply chain for polyester fiber has the potential to massively impact global energy and resource requirements.

Debido a que el poliéster representa aproximadamente el 60 por ciento de la producción mundial de PET, el desarrollo de una cadena de suministro no virgen para la fibra de poliéster tiene el potencial de impactar masivamente los requerimientos globales de energía y recursos.

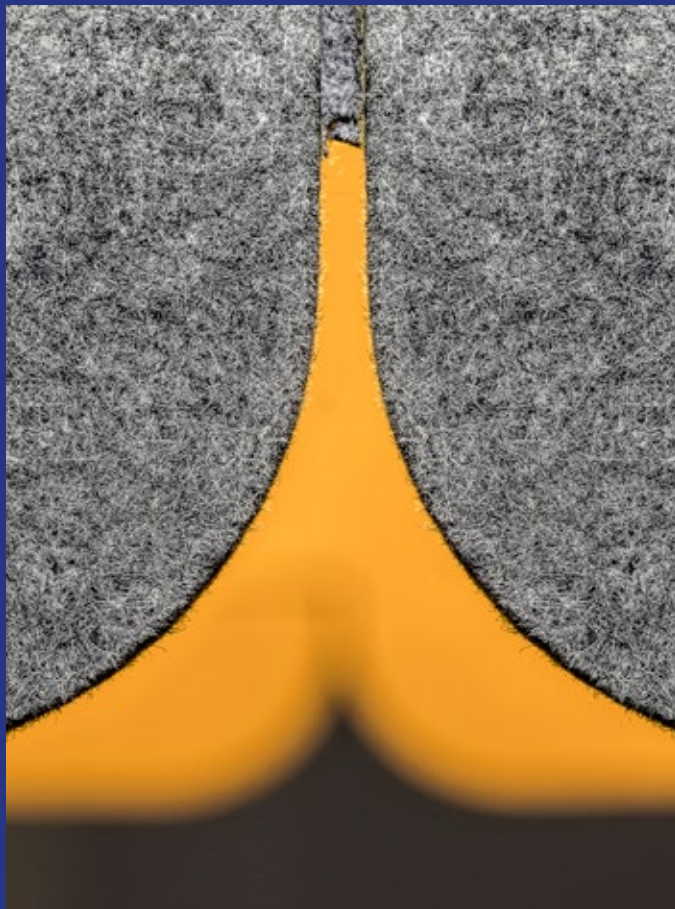

Sound Absorbing $\alpha = 0.9$

Noise in offices and workplaces has direct consequences on worker performance. The most immediate one is the reduction of their concentration. Workers exposed to continuous noise in their workplace are less effective in their work tasks. Concentration often means giving the brain a break to think better and focus on an activity. Luminaires made from fabrics with noise-absorbing properties are perfect for work spaces with high noise levels and acoustic distractions.

El ruido en las oficinas y lugares de trabajo tiene consecuencias directas en el rendimiento de los trabajadores. La más inmediata es la reducción de su concentración. Los trabajadores expuestos a un ruido continuo en su lugar de trabajo son menos eficaces en sus tareas. La concentración suele significar dar un respiro al cerebro para pensar mejor y centrarse en una actividad. Las luminarias fabricadas con tejidos con propiedades de absorción del ruido son perfectas para espacios de trabajo con altos niveles de ruido y distracciones acústicas.

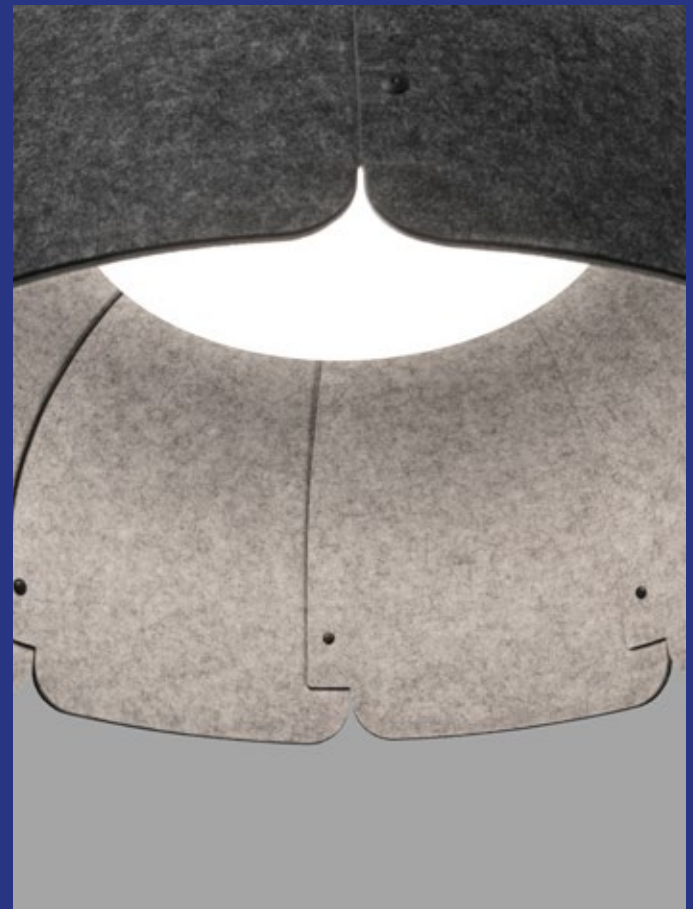



Restaurant



Office

Beam Angle



90°



Thanks to BEDEO relational/project

Thanks to Estudio SaQuira | Interior designer: Mercè Font





Need consulting
for your project?
¿Necesitas
asesoramiento
para tu proyecto?

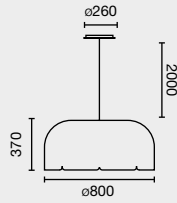

MUTE ø80 24W

incl. DIM 50.000hs L70 / B10 MacAdam 3 100-240V 50 / 60Hz 850°C UGR <19



Reference	Finish	Power	Color T°	Control System
20101	Dark grey+grey	24W	3000K CRI>80	DA 
20102	Dark grey+brown	24W	3000K CRI>80	ON/OFF
20103	Dark grey+grey	24W	4000K CRI>80	
20104	Dark grey+brown	24W	4000K CRI>80	

20101

DA

Example **20101DA** — Mute ø80 24W 3000K CRI>80 Dark Grey+grey Dali

Option	Color T°	CRI	Power	Lumen Output	Beam Angle
20101	3000K	>80	24W	1014lm	90°
20102	3000K	>80	24W	1014lm	90°
20103	4000K	>80	24W	1044lm	90°
20104	4000K	>80	24W	1044lm	90°



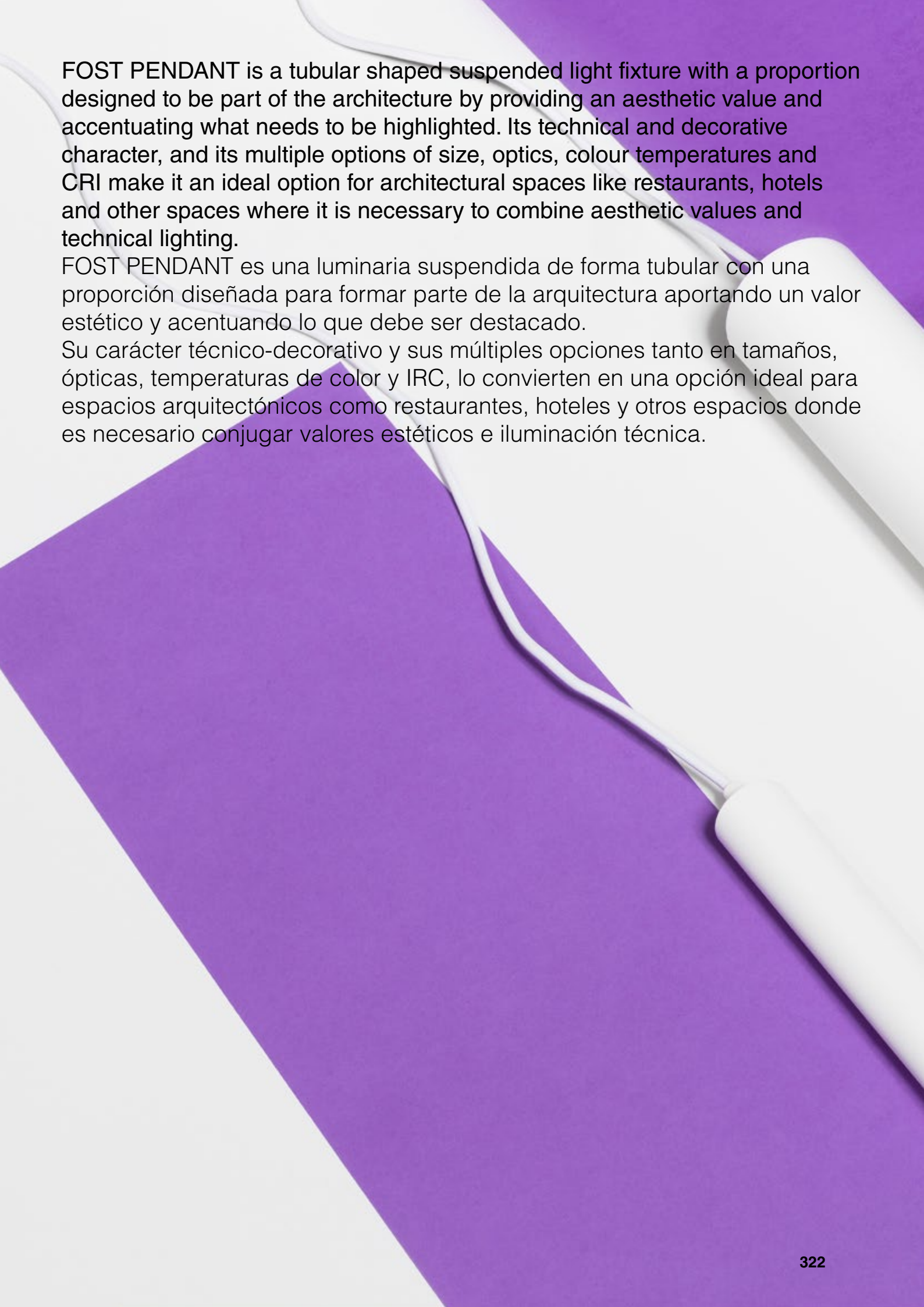

FOST PENDANT is a tubular shaped suspended light fixture with a proportion designed to be part of the architecture by providing an aesthetic value and accentuating what needs to be highlighted. Its technical and decorative character, and its multiple options of size, optics, colour temperatures and CRI make it an ideal option for architectural spaces like restaurants, hotels and other spaces where it is necessary to combine aesthetic values and technical lighting.

FOST PENDANT es una luminaria suspendida de forma tubular con una proporción diseñada para formar parte de la arquitectura aportando un valor estético y acentuando lo que debe ser destacado.

Su carácter técnico-decorativo y sus múltiples opciones tanto en tamaños, ópticas, temperaturas de color y IRC, lo convierten en una opción ideal para espacios arquitectónicos como restaurantes, hoteles y otros espacios donde es necesario conjugar valores estéticos e iluminación técnica.

F O O S T



P E N D A N T



FOST Collection



Track
47



Recessed
171



Pulldown
181



Ceiling
277



Surface
267

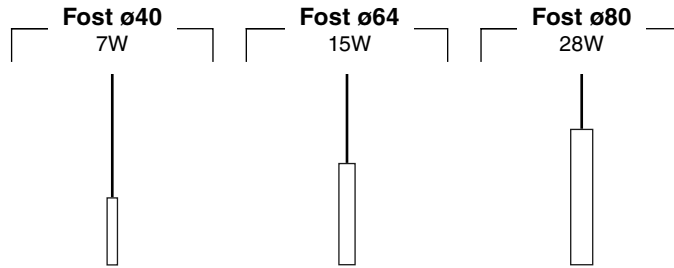

FINISH
Acabado

● **Black**
Negro

○ **White**
Blanco

COLOR TEMPERATURE
Temperatura de color

2700K CRI90	3000K CRI90	4000K CRI90
2700K CRI97	3000K CRI97	4000K CRI97
MEAT	BREAD	FASHION

BEAM ANGLE
Ángulo de apertura



ACCESSORIES
Accesorios



CONTROL SYSTEM
Sistema de control





White Ring



Copper Ring

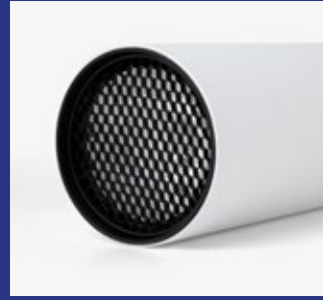

Honeycomb

Its multiple accessories and combinations facilitate the product's personalisation, giving it certain architectural relevance and at the same time making it possible to modify the beam or reduce glare.

Sus múltiples accesorios y combinaciones facilitan la personalización del producto que hace posible la modificación de haz o reducir el deslumbramiento.

Accesorios

	Honeycomb	White Ring	Copper Ring
ø40	-	011500099	011500098
ø64	011700094	011700099	011700098
ø80	011300097	011300099	011300098



Restaurant

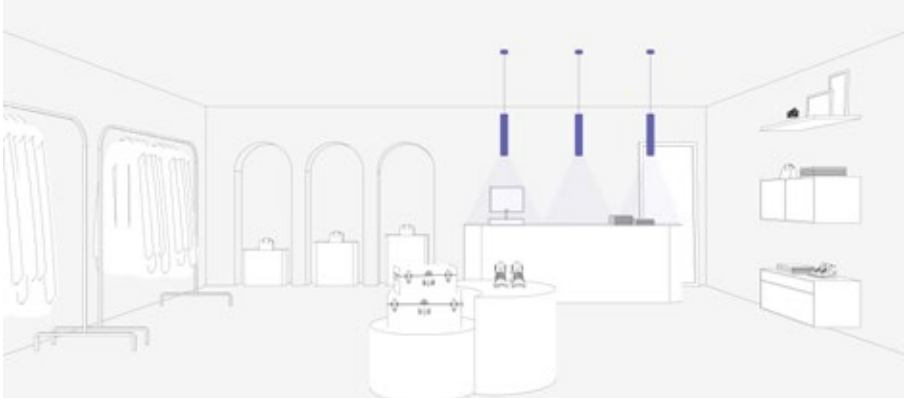

Retail

Beam Angle

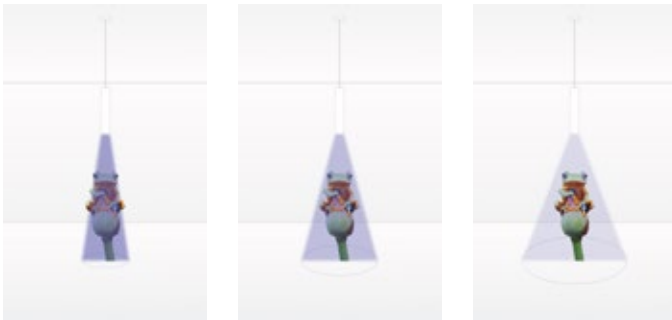

17/18°

23/25°

35/38°



Thanks to EMMME Studio | Photo by Lupe Clemente



FOST PENDANT ø40

incl. 50.000hs L80 / B10 MacAdam 2 & 3 220-240V 50 / 60Hz 650°C



Family	Color T°	Beam Angle	Finish	Control System
0411 Fost Pendant ø40 7W	927 2700K CRI90	1 18° 2 23° 3 35°	1 White	ON/OFF DALI
	930 3000K CRI90		2 Black	
	940 4000K CRI90			
	X27 2700K CRI97			
	X30 3000K CRI97			
	X40 4000K CRI97			

0411 927 1 1

Example 041192711 — Fost Pendant ø40 7W 2700K CRI90 18° White

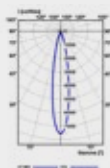

18°

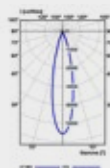

23°

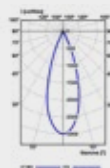

35°

Option	Color T°	CRI	Power	Lumen Output	Beam Angle
927	2700K	90	7W	632lm / 553lm / 586lm	18° / 23° / 35°
X27		97	7W	569lm / 498lm / 527lm	
930	3000K	90	7W	652lm / 570lm / 604lm	18° / 23° / 35°
X30		97	7W	587lm / 513lm / 544lm	
940	4000K	90	7W	652lm / 587lm / 622lm	18° / 23° / 35°
X40		97	7W	587lm / 528lm / 560lm	

FOST PENDANT ø64

incl. DIM 50.000hs L80 / B10 MacAdam 2 & 3 220-240V 50 / 60Hz 650°C

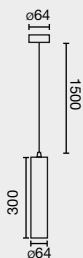

Family

Color T°

Beam Angle

Finish

Control System

0412 Fost Pendant ø64 14W

- 927** 2700K CRI90
- 930** 3000K CRI90
- 940** 4000K CRI90
- X27** 2700K CRI97
- X30** 3000K CRI97
- X40** 4000K CRI97

- 1** 17°
- 2** 25°
- 3** 35°

- 1** White
- 2** Black

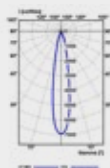
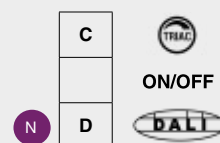

17°

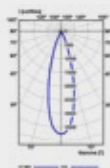

25°

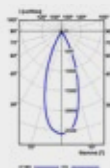

35°

Option	Color T°	CRI	Power	Lumen Output	Beam Angle
927	2700K	90	14W	1372lm / 1553lm / 1503lm	17° / 25° / 35°
X27	2700K	97	14W	1235lm / 1398lm / 1352lm	17° / 25° / 35°
930	3000K	90	14W	1414lm / 1601lm / 1549lm	17° / 25° / 35°
X30	3000K	97	14W	1273lm / 1441lm / 1394lm	17° / 25° / 35°
940	4000K	90	14W	1457lm / 1650lm / 1596lm	17° / 25° / 35°
X40	4000K	97	14W	1311lm / 1484lm / 1436lm	17° / 25° / 35°

FOST PENDANT ø80

incl. DIM 50.000hs L80 / B10 MacAdam 2 & 3 220-240V 50 / 60Hz 650°C

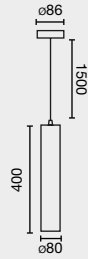

Family	Color T°	Beam Angle	Finish	Control System
0413 Fost Pendant ø80 28W	927 2700K CRI90	1 18°	1 White	D DALI
	930 3000K CRI90	2 23°	2 Black	C TRIAC
	940 4000K CRI90	3 38°		ON/OFF
	X27 2700K CRI97			
	X30 3000K CRI97			
	X40 4000K CRI97			

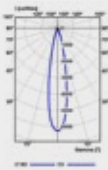

18°

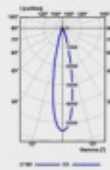

23°

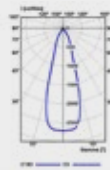

38°

Option	Color T°	CRI	Power	Lumen Output	Beam Angle
927	2700K	90	28W	1684lm / 1772lm / 1334lm	18° / 23° / 38°
X27		97	28W	1515lm / 1595lm / 1200lm	18° / 23° / 38°
930	3000K	90	28W	1736lm / 1827lm / 1375lm	18° / 23° / 38°
X30		97	28W	1562lm / 1644lm / 1237m	18° / 23° / 38°
940	4000K	90	28W	1788lm / 1882lm / 1416lm	18° / 23° / 38°
X40		97	28W	1609lm / 1693lm / 1274lm	18° / 23° / 38°





S Y S T E M S

CONFIGURE YOUR NESO

Also for your mobile phone
También para tu teléfono móvil

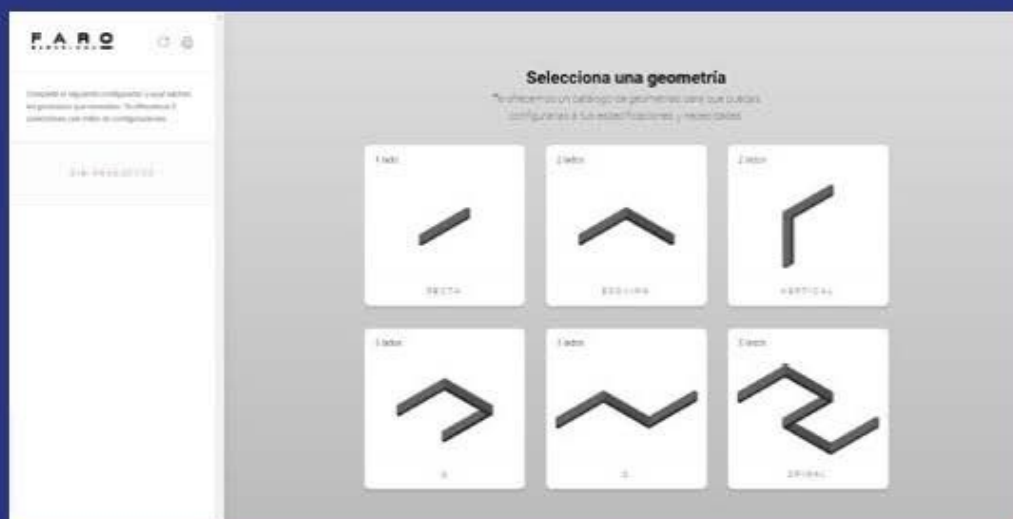
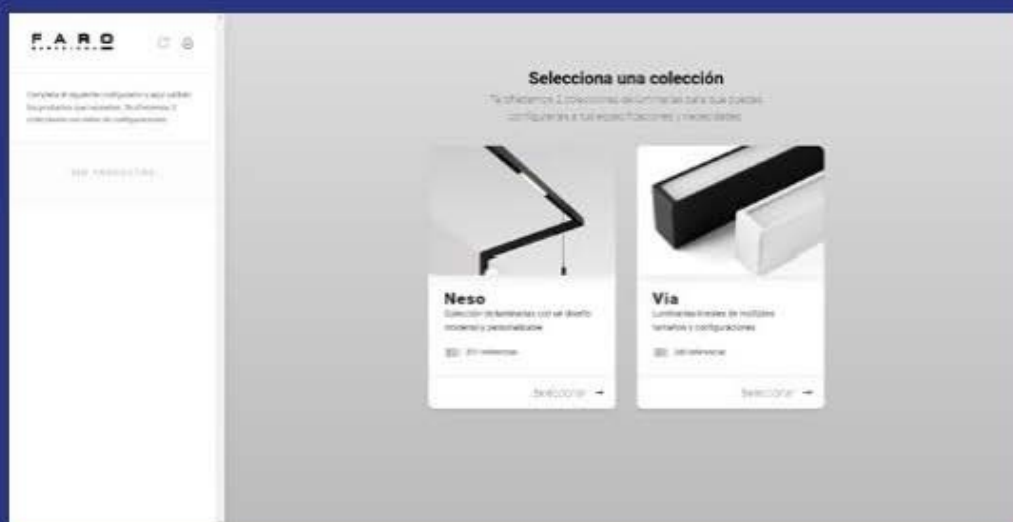

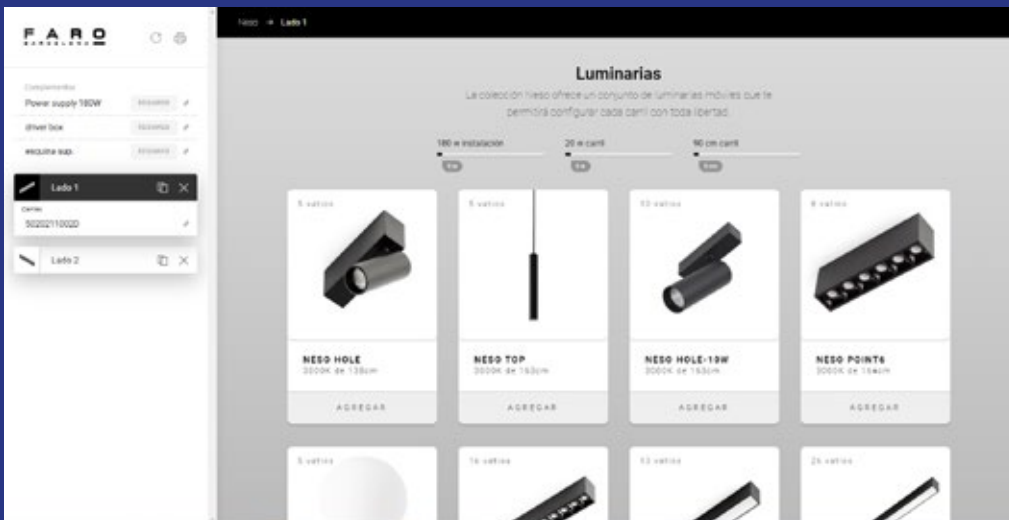
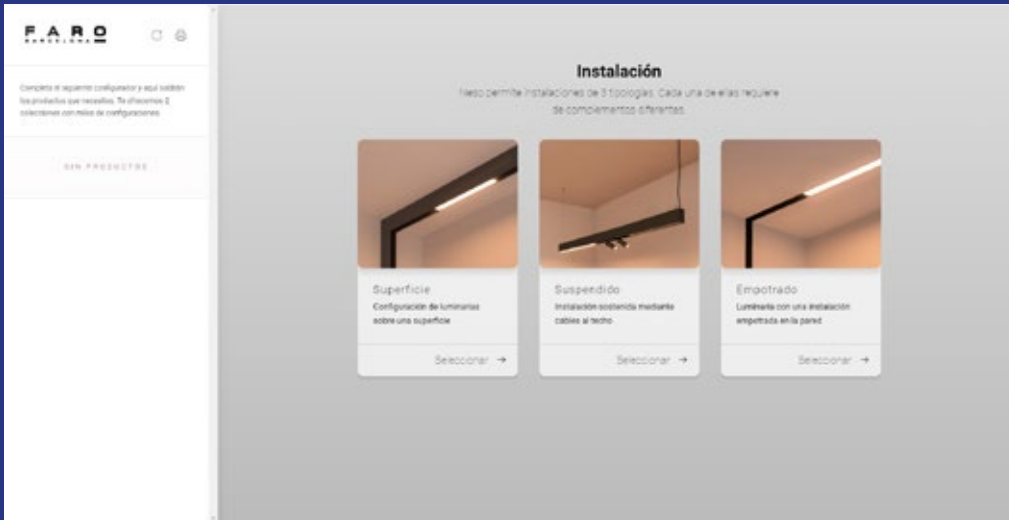

NESO, a magnetic track system, seamlessly integrates various luminaires, ranging from general lights to striking accents. Its modular and magnetic design not only provides flexibility but also transforms environments with its exceptional adaptability and design. Ideal for commercial settings, NESO offers projectors with up to 20W, whereas NESO Slim, tailored for residential spaces, brings elegance and an endless array of options to craft truly unique atmospheres.

NESO, un sistema de carril magnético, fusiona distintas luminarias, abarcando desde luces generales hasta resaltantes acentos. Su diseño modular y magnético no solo brinda flexibilidad, sino que también transforma entornos con su adaptabilidad y diseño excepcional. Perfecto para entornos comerciales, NESO ofrece proyectores de hasta 20W, mientras que NESO Slim, diseñado para espacios residenciales, aporta elegancia y una variedad ilimitada de opciones para crear ambientes verdaderamente únicos.



THE MAGNETIC TRACK SYSTEM

NESO



Highlights

Neso Slim



Super Slim design
Diseño Super Slim



Maximum integration of luminaires on rail
Integración máxima de las luminarias en carril

Neso Slim and Standard



Magnetic
Magnético



Versatility
Versatilidad

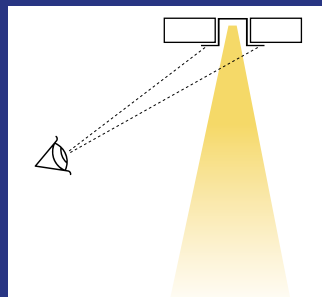

UGR<16 Option



Connectivity
Conectividad



NESO



TRACKS
Carriles

RECESSED
Empotrable

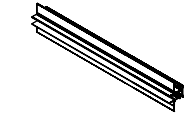

1000 | 2000

SURFACE
Superficie

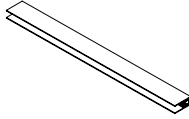

1000 | 2000

PENDANT
Colgante

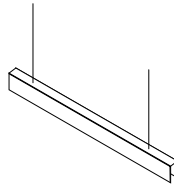

1000 | 2000

MODULES
Módulos

Neso
Point



84



164



320

Neso
Unik



ø150

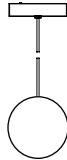

ø150

Neso
Line



320



640

Neso
Hole

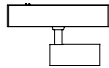

ø35

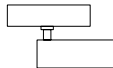

ø50

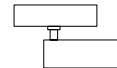

ø70

Neso
Top

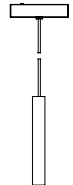

ø35

FINISH
Acabado

● **Black**
Negro

○ **White**
Blanco

COLOR TEMPERATURE
Temperatura de color

2700K CRI>90

3000K CRI>90



Thanks to Detail Studio | Photo by Julien Chamoux Photographie



TRACK RECESSED

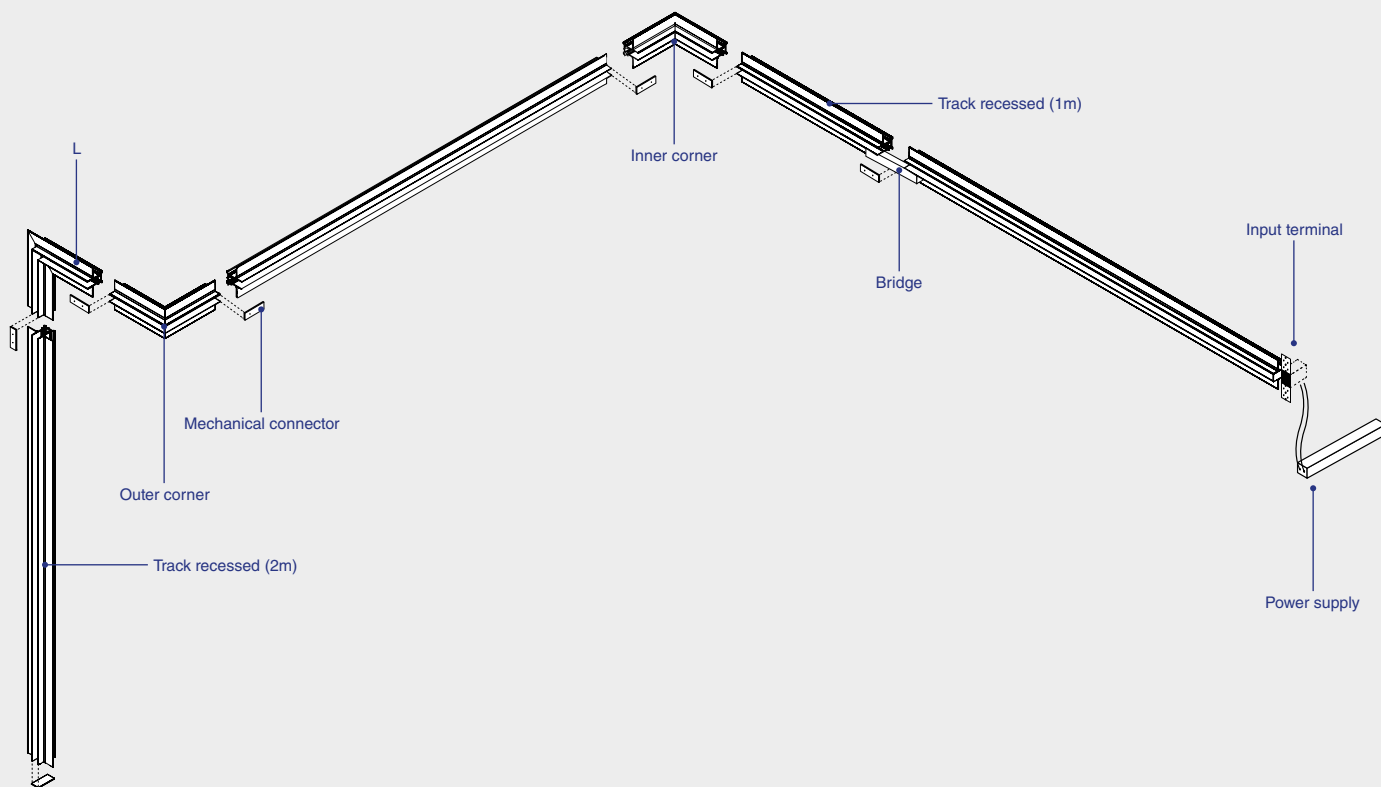

III 24V

Family	Track Length	Finish	Control System
5020120 Neso Track Recessed	10 1m	1 White	D ON/OFF
	20 2m	2 Black	

ACCESSORIES

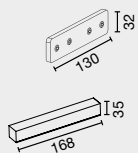

● 5020200102	Mechanical connector
● 5020115101 / ● 5020115102	Bridge
● 5020115101D / ● 5020115102D	Bridge DALI

● 5020R120102	Track cover
---------------	-------------

POWER SUPPLY

98324120	Power supply 120W
98324150	Power supply 150W
98324180	Power supply 180W
98324200	Power supply 200W

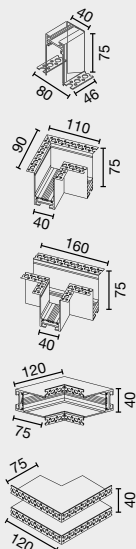

● 5020221401 / ● 5020221402	Input terminal
● 5020221401D / ● 5020221402D	Input terminal DALI
● 5020221001 / ● 5020221002	L
● 5020221001D / ● 5020221002D	L DALI
● 5020221101 / ● 5020221102	T
● 5020221101D / ● 5020221102D	T DALI
● 5020221201 / ● 5020221202	Inner corner
● 5020221201D / ● 5020221202D	Inner corner DALI
● 5020221301 / ● 5020221302	Outer corner
● 5020221301D / ● 5020221302D	Outer corner DALI

TRACK SURFACE & SUSPENSION

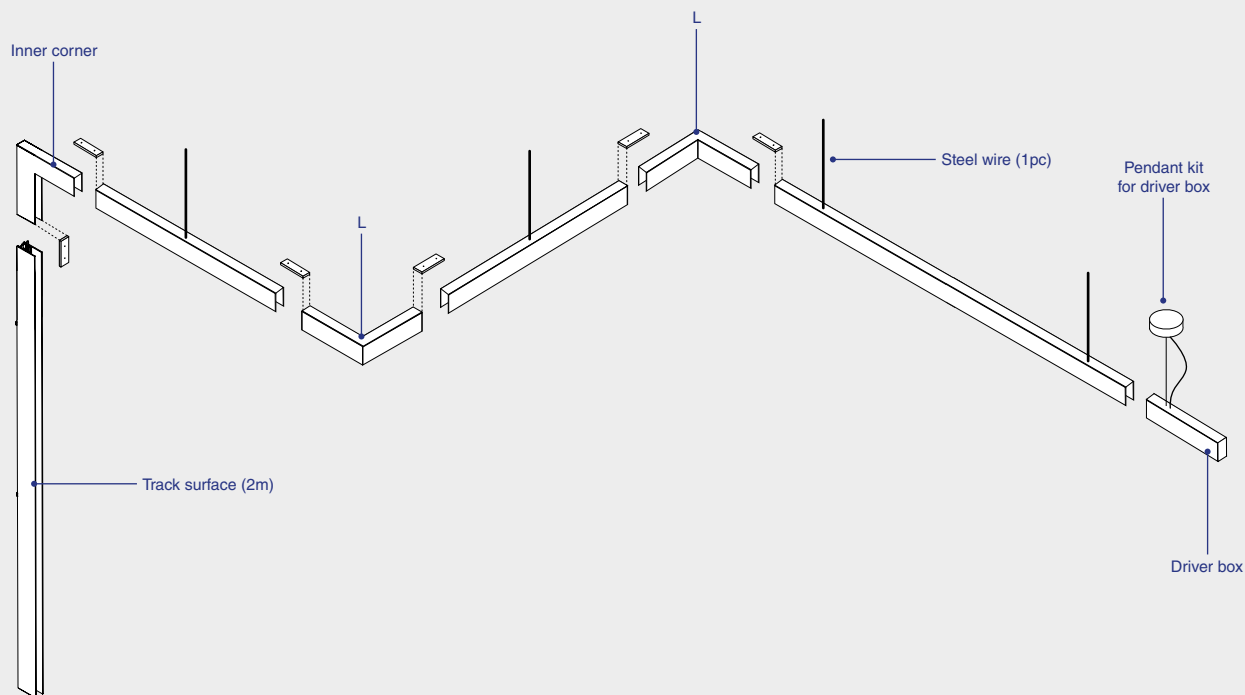

24V

Family	Track Length	Finish	Control System
5020110 Neso Track Surface	10 1m	1 White	D ON/OFF
	20 2m	2 Black	

ACCESSORIES

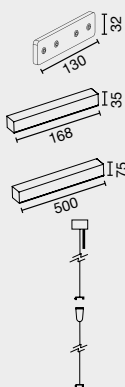

● 5020200102	Mechanical connector
● 5020115101 / ● 5020115102	Bridge
● 5020115101D / ● 5020115102D	Bridge DALI
● 5020210001 / ● 5020210002	Driver box
● 5020210001D / ● 5020210002D	Driver box DALI
● 5020210201 / ● 5020210202	Pendant kit
● 5020210201D / ● 5020210202D	Pendant kit DALI
5020210102	Steel wire
● 5020R120102	Track cover
POWER SUPPLY	
98324120	Power supply 120W
98324150	Power supply 150W
98324180	Power supply 180W
98324200	Power supply 200W

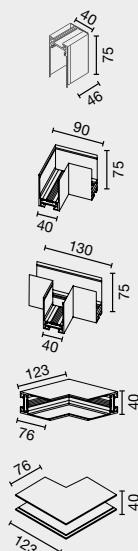

● 5020210301 / ● 5020210302	Input terminal
● 5020210301D / ● 5020210302D	Input terminal DALI
● 5020211001 / ● 5020211002	L
● 5020211001D / ● 5020211002D	L DALI
● 5020211101 / ● 5020211102	T
● 5020211101D / ● 5020211102D	T DALI
● 5020211201 / ● 5020211202	Inner corner
● 5020211201D / ● 5020211202D	Inner corner DALI
● 5020211301 / ● 5020211302	Outer corner
● 5020211301D / ● 5020211302D	Outer corner DALI

NESO POINT 3L

no incl. 50.000hs L70/B10 MacAdam 3 24V 650°C UGR <16

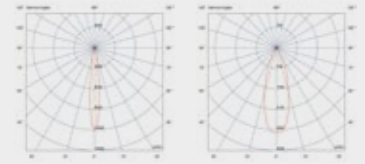
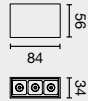

12°

34°

Family	Color T°	Beam Angle	Finish
50101 Point 3L 4W	927 2700K 217lm CRI>90	1 12°	1 White
	930 3000K 292lm CRI>90	2 34°	2 Black

NESO POINT 6L

no incl. 50.000hs L70/B10 MacAdam 3 24V 650°C UGR <16

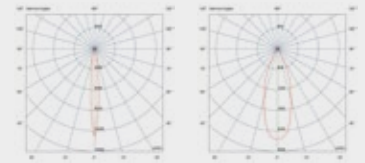
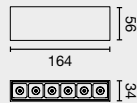

12°

34°

Family	Color T°	Beam Angle	Finish	Control System
50102 Point 6L 8W	927 2700K 480lm CRI>90	1 12°	1 White	<input type="checkbox"/> N <input type="checkbox"/> W CASAMBI <input type="checkbox"/> D DALI <input type="checkbox"/> ON/OFF
	930 3000K 506lm CRI>90	2 34°	2 Black	

NESO POINT 12L

no incl. 50.000hs L70/B10 MacAdam 3 24V 650°C UGR <16

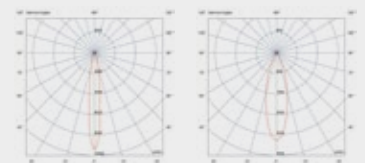
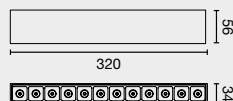

12°

34°

Family	Color T°	Beam Angle	Finish	Control System
50103 Point 12L 16W	927 2700K 1102lm CRI>90	1 12°	1 White	<input type="checkbox"/> N <input type="checkbox"/> W CASAMBI <input type="checkbox"/> D DALI <input type="checkbox"/> ON/OFF
	930 3000K 1107lm CRI>90	2 34°	2 Black	



NESO LINE 32cm

no incl. 50.000hs L70/B10  MacAdam 3 24V  650°C

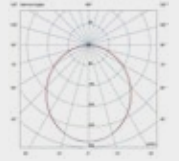
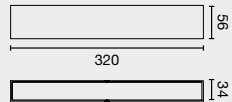

32

Family

Color T°

Finish

Control System

50104 Line 32cm 13W

927 2700K 892lm CRI>90

930 3000K 920lm CRI>90

01 White

02 Black

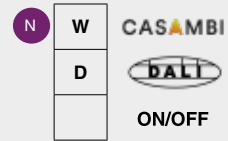

NESO LINE 64cm

no incl. 50.000hs L70/B10  MacAdam 3 24V  650°C

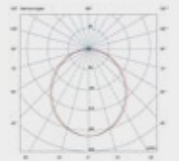
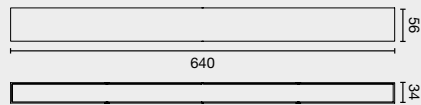

64

Family

Color T°

Finish

Control System

50105 Line 64cm 26W

927 2700K 1399lm CRI>90

930 3000K 1442lm CRI>90

01 White

02 Black

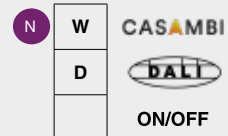



NESO HOLE ø3.5cm

no incl. 50.000hs L70/B10 MacAdam 3 24V 650°C

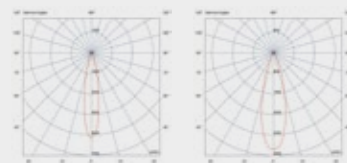
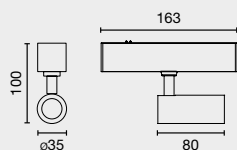

20°

40°

Family

Color T°

Beam Angle

Finish

Control System

50107 Hole ø3,5cm 5W

927 2700K 360lm CRI>90

1 20°

1 White

N W CASAMBI

930 3000K 444lm CRI>90

2 40°

2 Black

D DALI

ON/OFF

NESO HOLE ø5cm

no incl. 50.000hs L70/B10 MacAdam 3 24V 650°C

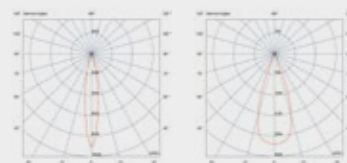
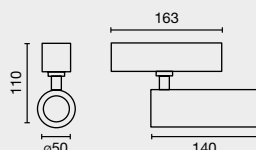

18°

36°

Family

Color T°

Beam Angle

Finish

Control System

50108 Hole ø5cm 10W

027 2700K 445lm CRI>90

1 18°

1 White

N W CASAMBI

030 3000K 592lm CRI>90

2 36°

2 Black

D DALI

ON/OFF

NESO HOLE ø7cm

N

no incl. 50.000hs L70/B10 MacAdam 3 24V 650°C

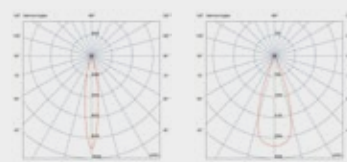
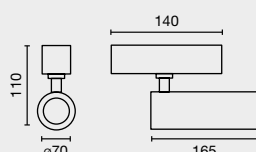

18°

36°

Family

Color T°

Beam Angle

Finish

Control System

50110 Hole ø7cm 20W

027 2700K 903lm CRI90

1 18°

1 White

W CASAMBI

030 3000K 930lm CRI90

2 36°

2 Black

D DALI

ON/OFF



NESO UNIK

no incl. 50.000hs L70/B10 MacAdam 3 24V 650°C

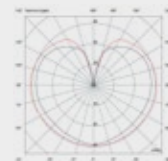
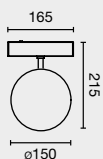

325°

Family

Color T°

Finish

Control System

50108 Unik 5W

927 2700K 256lm CRI>90

01 White

N W CASAMBI

930 3000K 264lm CRI>90

02 Black

D BALI

ON/OFF

NESO UNIK

no incl. 50.000hs L70/B10 MacAdam 3 24V 650°C

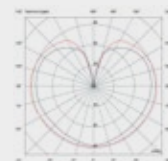
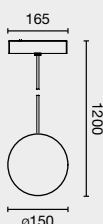

325°

Family

Color T°

Finish

Control System

50109 Unik 5W

027 2700K 256lm CRI>90

01 White

N W CASAMBI

030 3000K 264lm CRI>90

02 Black

D BALI

ON/OFF

NESO TOP

no incl. 50.000hs L70/B10 MacAdam 3 24V 650°C

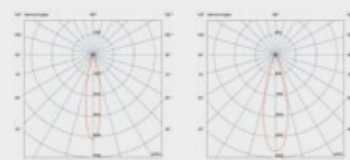
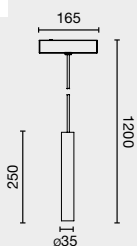

20°

40°

Family

Color T°

Beam Angle

Finish

Control System

50106 Top 5W

927 2700K 360m CRI>90

1 20°

1 White

N W CASAMBI

930 3000K 444lm CRI>90

2 40°

2 Black

D BALI

ON/OFF



NESO SLIM



TRACKS
Carriles

RECESSED
Empotrable

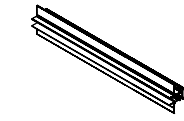

1000 | 2000

SURFACE
Superficie

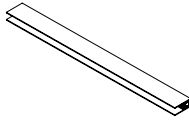

1000 | 2000

PENDANT
Colgante

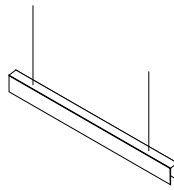

1000 | 2000

MODULES
Módulos

Neso Slim
Point



305



388

Neso Slim
Unik



ø150

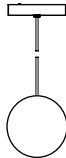

ø150

Neso Slim
Line

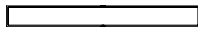

305

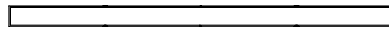

704

Neso Slim
Hole

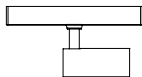

ø35

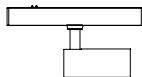

ø50

Neso Slim
Top

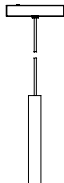

ø35

FINISH
Acabado

● **Black**
Negro

COLOR TEMPERATURE
Temperatura de color

2700K CRI>90

3000K CRI>90

TRACK RECESSED

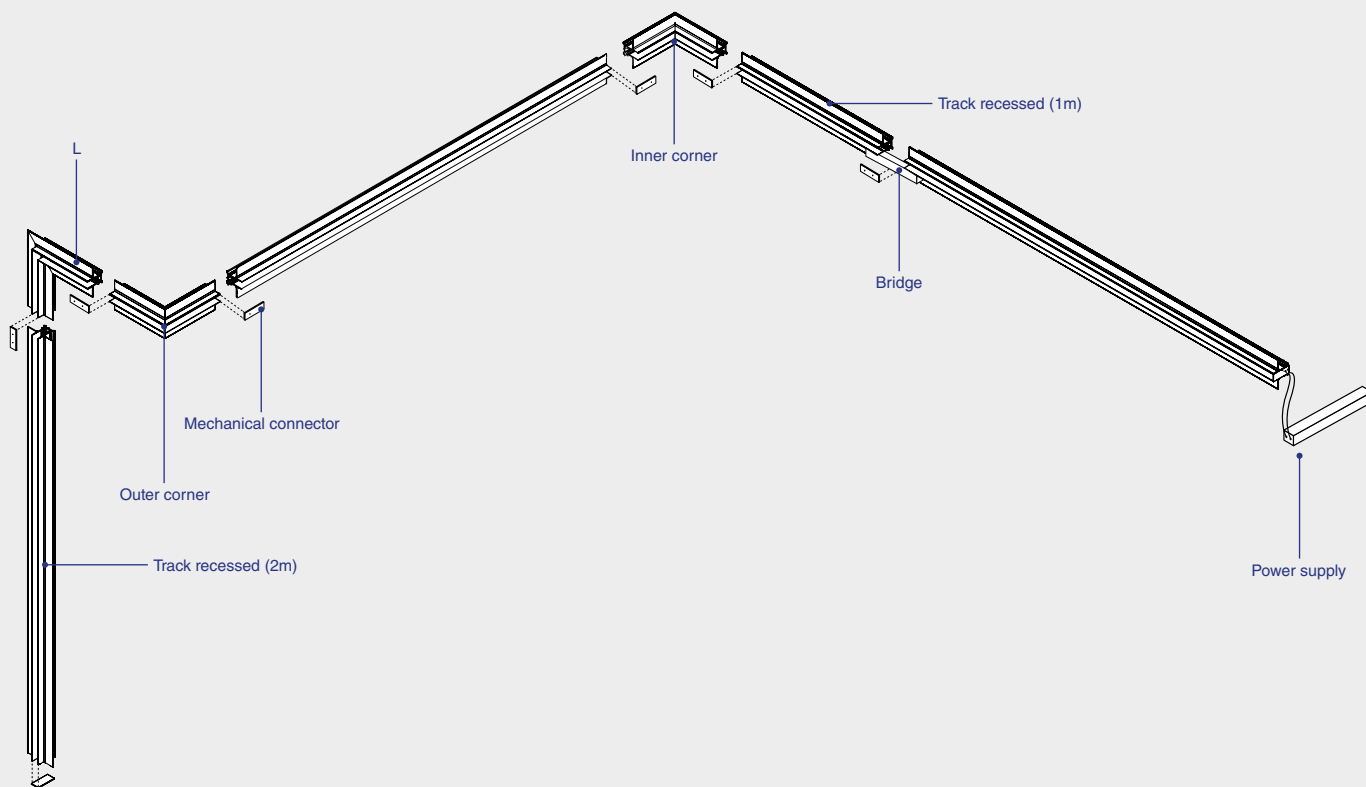

24V

Family	Track Length	Finish	Control System
6020120 Neso Track Recessed	10 1m	2 Black	D ON/OFF
	20 2m	2	

ACCESSORIES

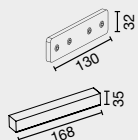

● 6020200102	Mechanical connector
● 6020115102	Bridge
● 6020115102D	Bridge DALI
● 6020R120102	Track cover

POWER SUPPLY

98324120	Power supply 120W
98324150	Power supply 150W
98324180	Power supply 180W
98324200	Power supply 200W

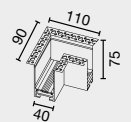

● 6020221002	L
● 6020221002D	L DALI

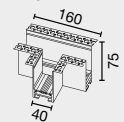

● 6020221102	T
● 6020221102D	T DALI

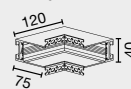

● 6020221202	Inner corner
● 6020221202D	Inner corner DALI

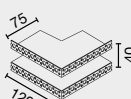

● 6020221302	Outer corner
● 6020221302D	Outer corner DALI

TRACK SURFACE & SUSPENSION

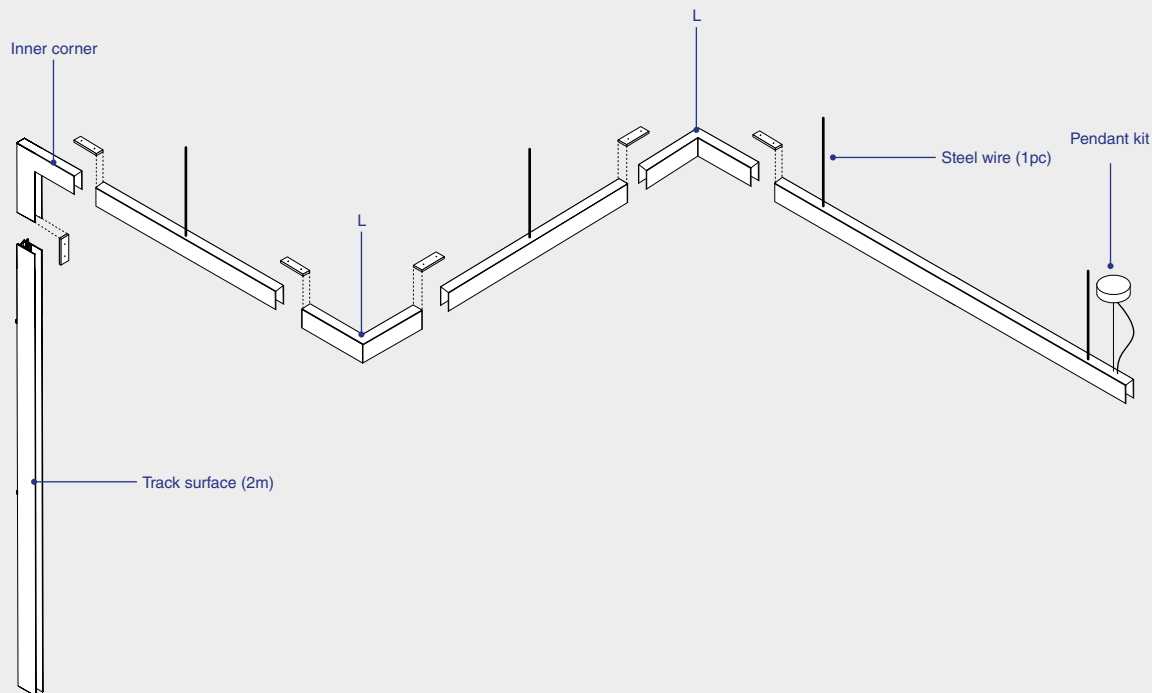

24V

Family	Track Length	Finish	Control System
6020110 Neso Track Surface	10 1m	2 Black	D 
	20 2m	2	ON/OFF

ACCESSORIES



● 6020200102	Mechanical connector
● 6020200103	Surface mounting Kit
● 6020210202	Pendant Kit
● 6020210202D	Pendant kit DALI

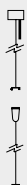

6020210102	Steel wire
5020R120102	Track cover

POWER SUPPLY

98324120	Power supply 120W
98324150	Power supply 150W
98324180	Power supply 180W
98324200	Power supply 200W

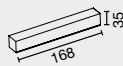

● 6020115102	Bridge
● 6020115102D	Bridge DALI

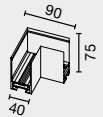

● 6020211002	L
● 6020211002D	L DALI

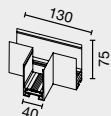

● 6020211102	T
● 6020211102D	T DALI

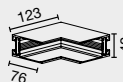

● 6020211202	Inner corner
● 6020211202D	Inner corner DALI

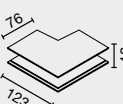

● 6020211302	Outer corner
● 6020211302D	Outer corner DALI

NESO SLIM POINT 12L

NEW

no incl. 50.000hs L70/B10 MacAdam 3 24V 650°C UGR <16

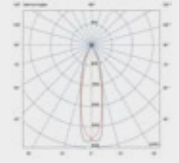
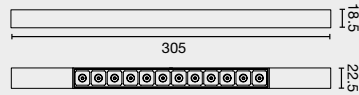

25°

Family	Color T°	Beam Angle	Finish	Control System						
60102 Point slim 12L 12W	927 2700K 480lm CRI>90 930 3000K 506lm CRI>90	1 25°	2 Black	<table border="1"> <tr><td>W</td><td>CASAMBI</td></tr> <tr><td>D</td><td>BALI</td></tr> <tr><td></td><td>ON/OFF</td></tr> </table>	W	CASAMBI	D	BALI		ON/OFF
W	CASAMBI									
D	BALI									
	ON/OFF									

NESO SLIM POINT 24L

NEW

no incl. 50.000hs L70/B10 MacAdam 3 24V 650°C UGR <16

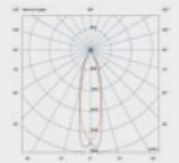

25°

Family	Color T°	Beam Angle	Finish	Control System						
60103 Point slim 24L 24W	927 2700K 1102lm CRI>90 930 3000K 1135lm CRI>90	1 25°	2 Black	<table border="1"> <tr><td>W</td><td>CASAMBI</td></tr> <tr><td>D</td><td>BALI</td></tr> <tr><td></td><td>ON/OFF</td></tr> </table>	W	CASAMBI	D	BALI		ON/OFF
W	CASAMBI									
D	BALI									
	ON/OFF									



NESO SLIM LINE 30cm

NEW

no incl. 50.000hs L70/B10   MacAdam 3 24V  650°C

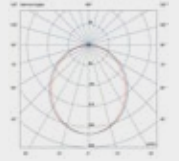
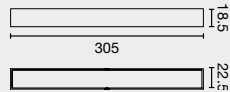

Family

Color T°

Finish

Control System

60104 Line slim 30cm 6W

927 2700K 892lm CRI>90

02 Black

W CASAMBI

D DALI

ON/OFF

930 3000K 920lm CRI>90

NESO SLIM LINE 70cm

NEW

no incl. 50.000hs L70/B10   MacAdam 3 24V  650°C

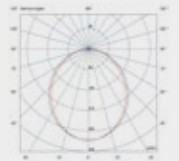
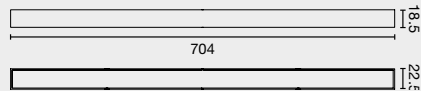

Family

Color T°

Finish

Control System

60105 Line slim 70cm 18W

927 2700K 1399lm CRI>90

02 Black

W CASAMBI

D DALI

ON/OFF

930 3000K 1442lm CRI>90



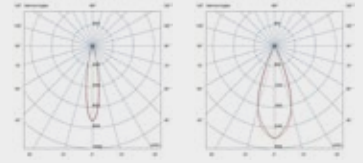
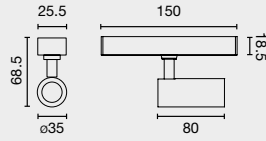

NESO SLIM HOLE ø3.5cm NEW

no incl. 50.000hs L70/B10  MacAdam 3 24V  650°C



20°

40°

Family	Color T°	Beam Angle	Finish	Control System						
60107 Hole slim ø3,5cm 5W	927 2700K 360lm CRI>90	1 20°	2 Black	<table border="1"> <tr> <td>W</td> <td>CASAMBI</td> </tr> <tr> <td>D</td> <td></td> </tr> <tr> <td></td> <td>ON/OFF</td> </tr> </table>	W	CASAMBI	D			ON/OFF
	W	CASAMBI								
D										
	ON/OFF									
	930 3000K 444lm CRI>90	2 40°								

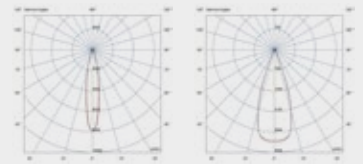
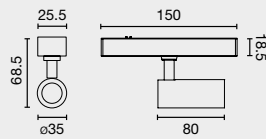

NESO SLIM HOLE ø5cm NEW

no incl. 50.000hs L70/B10  MacAdam 3 24V  650°C



18°

36°

Family	Color T°	Beam Angle	Finish	Control System						
60108 Hole slim ø5cm 10W	027 2700K 445lm CRI>90	1 18°	2 Black	<table border="1"> <tr> <td>W</td> <td>CASAMBI</td> </tr> <tr> <td>D</td> <td></td> </tr> <tr> <td></td> <td>ON/OFF</td> </tr> </table>	W	CASAMBI	D			ON/OFF
	W	CASAMBI								
D										
	ON/OFF									
	030 3000K 592lm CRI>90	2 36°								



NESO SLIM UNIK

NEW

no incl. 50.000hs L70/B10 MacAdam 3 24V 650°C

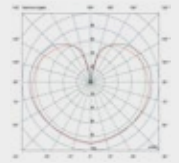
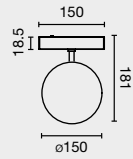

325°

Family **Color T°** **Finish** **Control System**

60108 Unik slim 5W **927** 2700K 256lm CRI>90 **02** Black
930 3000K 264lm CRI>90

W CASAMBI
D DALI
 ON/OFF

NESO SLIM UNIK PENDANT

NEW

no incl. 50.000hs L70/B10 MacAdam 3 24V 650°C

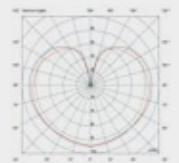
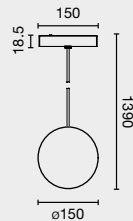

325°

Family **Color T°** **Finish** **Control System**

60109 Unik slim pendant 5W **027** 2700K 256lm CRI>90 **02** Black
030 3000K 264lm CRI>90

W CASAMBI
D DALI
 ON/OFF

NESO SLIM TOP

NEW

no incl. 50.000hs L70/B10 MacAdam 3 24V 650°C

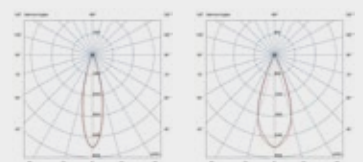
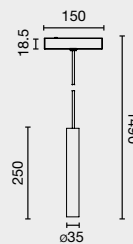

20°

40°

Family **Color T°** **Beam Angle** **Finish** **Control System**

60106 Top slim top 5W **927** 2700K 360m CRI>90 **1** 20°
930 3000K 444lm CRI>90 **2** 40° **2** Black

W CASAMBI
D DALI
 ON/OFF



NESO POINT 3L

Option	Color T°	CRI	Power	Lumen Output	Beam Angle
927	2700k	90	4W	217 / 221lm	12° / 34°
930	3000k	90	4W	292 / 298lm	12° / 34°

NESO POINT 6L

Option	Color T°	CRI	Power	Lumen Output	Beam Angle
927	2700k	90	8W	480 / 487lm	12° / 34°
930	3000k	90	8W	506 / 512lm	12° / 34°

NESO POINT 12L

Option	Color T°	CRI	Power	Lumen Output	Beam Angle
927	2700k	90	8W	1102 / 1109lm	12° / 34°
930	3000k	90	8W	1107 / 1112lm	12° / 34°

NESO LINE 32cm

Option	Color T°	CRI	Power	Lumen Output	Beam Angle
927	2700k	90	6W	892lm	100°
930	3000k	90	6W	920lm	100°

NESO LINE 64cm

Option	Color T°	CRI	Power	Lumen Output	Beam Angle
927	2700k	90	18W	1399lm	100°
930	3000k	90	18W	1442lm	100°

NESO HOLE ø3.5cm

Option	Color T°	CRI	Power	Lumen Output	Beam Angle
927	2700k	90	5W	360 / 372lm	20° / 40°
930	3000k	90	5W	592 / 602lm	20° / 40°

NESO HOLE ø5cm

Option	Color T°	CRI	Power	Lumen Output	Beam Angle
927	2700k	90	10W	825 / 932lm	18° / 36°
930	3000k	90	10W	954 / 961lm	18° / 36°

NESO HOLE ø7cm

Option	Color T°	CRI	Power	Lumen Output	Beam Angle
927	2700k	90	20W	925 / 931lm	18° / 36°
930	3000k	90	20W	954 / 961lm	18° / 36°

NESO UNIK

Option	Color T°	CRI	Power	Lumen Output	Beam Angle
927	2700k	90	5W	229lm	325°
930	3000k	90	5W	236lm	325°

NESO TOP

Option	Color T°	CRI	Power	Lumen Output	Beam Angle
927	2700k	90	5W	360 / 371lm	20° / 40°
930	3000k	90	5W	444 / 452lm	20° / 40°

NESO SLIM POINT 12L

Option	Color T°	CRI	Power	Lumen Output	Beam Angle
927	2700k	90	12W	816lm	25°
930	3000k	90	12W	841lm	25°

NESO SLIM POINT 24L

Option	Color T°	CRI	Power	Lumen Output	Beam Angle
927	2700k	90	24W	1674lm	25°
930	3000k	90	24W	1726lm	25°

NESO SLIM LINE 30cm

Option	Color T°	CRI	Power	Lumen Output	Beam Angle
927	2700k	90	6W	322lm	100°
930	3000k	90	6W	332lm	100°

NESO SLIM LINE 70cm

Option	Color T°	CRI	Power	Lumen Output	Beam Angle
927	2700k	90	18W	875lm	100°
930	3000k	90	18W	902lm	100°

NESO SLIM HOLE ø3.5cm

Option	Color T°	CRI	Power	Lumen Output	Beam Angle
927	2700k	90	5W	334 / 334lm	20° / 40°
930	3000k	90	5W	347 / 344lm	20° / 40°

NESO SLIM HOLE ø5cm

Option	Color T°	CRI	Power	Lumen Output	Beam Angle
927	2700k	90	10W	545 / 572lm	18° / 36°
930	3000k	90	10W	562 / 590lm	18° / 36°

NESO SLIM UNIK

Option	Color T°	CRI	Power	Lumen Output	Beam Angle
927	2700k	90	5W	308 / 305lm	20° / 40°
930	3000k	90	5W	318 / 314lm	20° / 40°

NESO SLIM TOP

Option	Color T°	CRI	Power	Lumen Output	Beam Angle
927	2700k	90	5W	229lm	325°
930	3000k	90	5W	236lm	325°

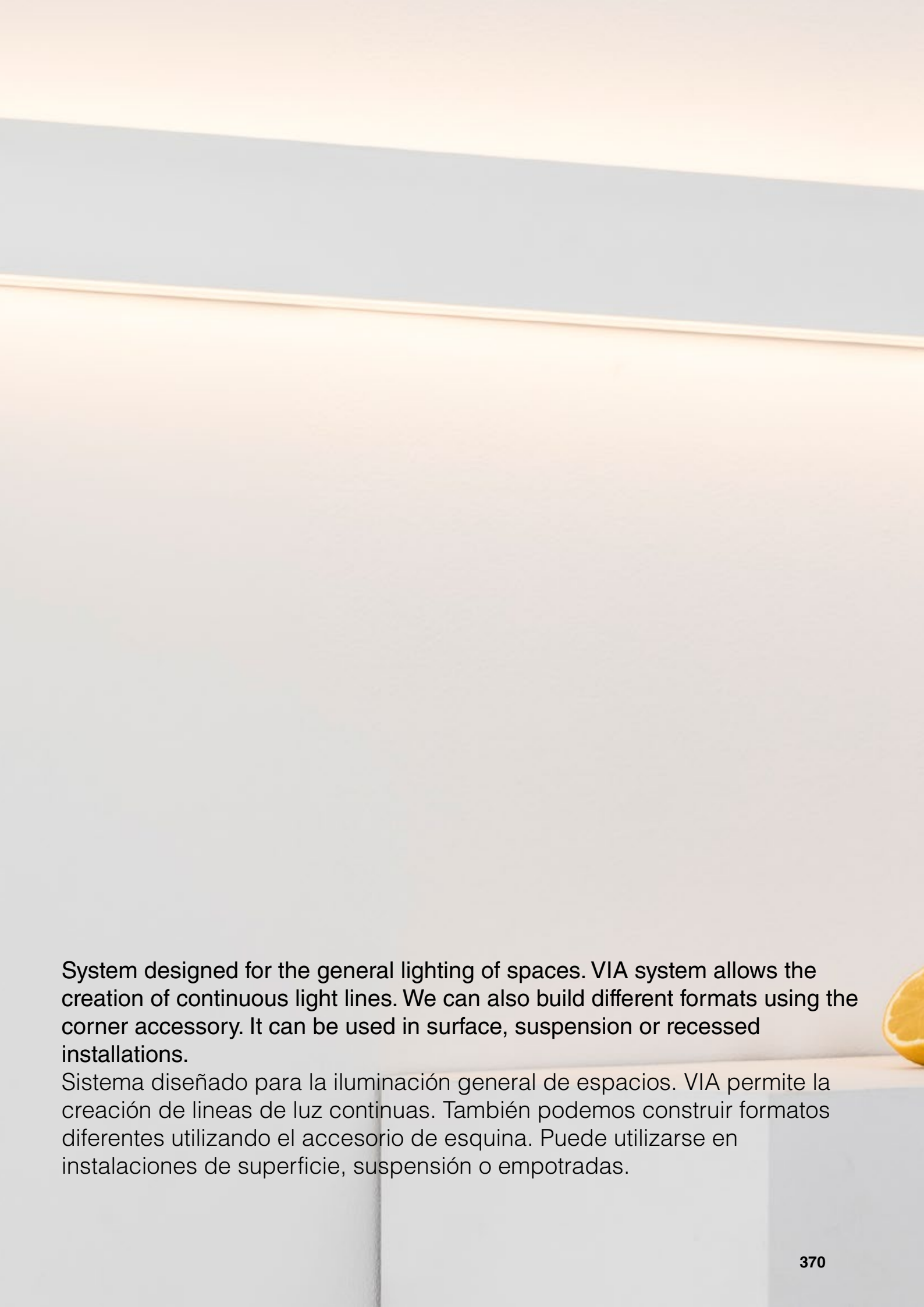

System designed for the general lighting of spaces. VIA system allows the creation of continuous light lines. We can also build different formats using the corner accessory. It can be used in surface, suspension or recessed installations.

Sistema diseñado para la iluminación general de espacios. VIA permite la creación de líneas de luz continuas. También podemos construir formatos diferentes utilizando el accesorio de esquina. Puede utilizarse en instalaciones de superficie, suspensión o empotradas.

WIA



E V O L U T I O N



VIA Collection



Track
67

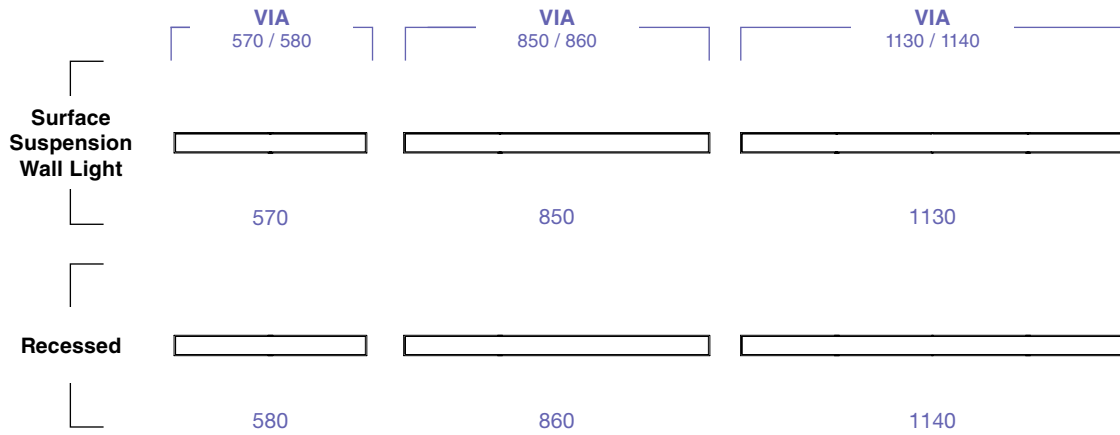

LIGHT DIRECTION
Dirección de la luz

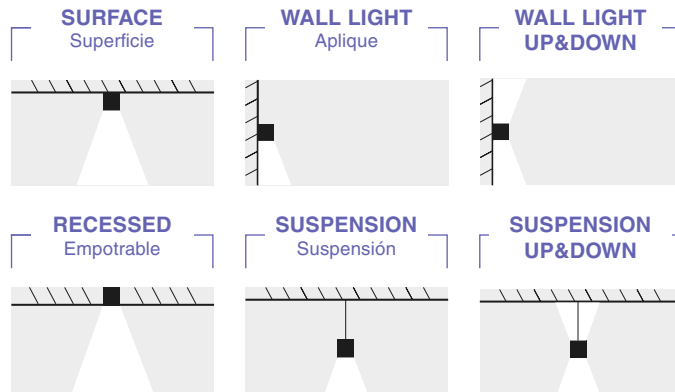

FINISH
Acabado

- Black**
Negro
- White**
Blanco

COLOR TEMPERATURE
Temperatura de color

- 3000K CRI80
- 4000K CRI80
- 2700-3000K
- LEAF** *

DIFFUSER
Difusor

- Opal
- Microprisma
- UGR

CONTROL SYSTEM
Sistema de Control



* Leaf. More information on page 31
* Leaf. Más información en la página 31

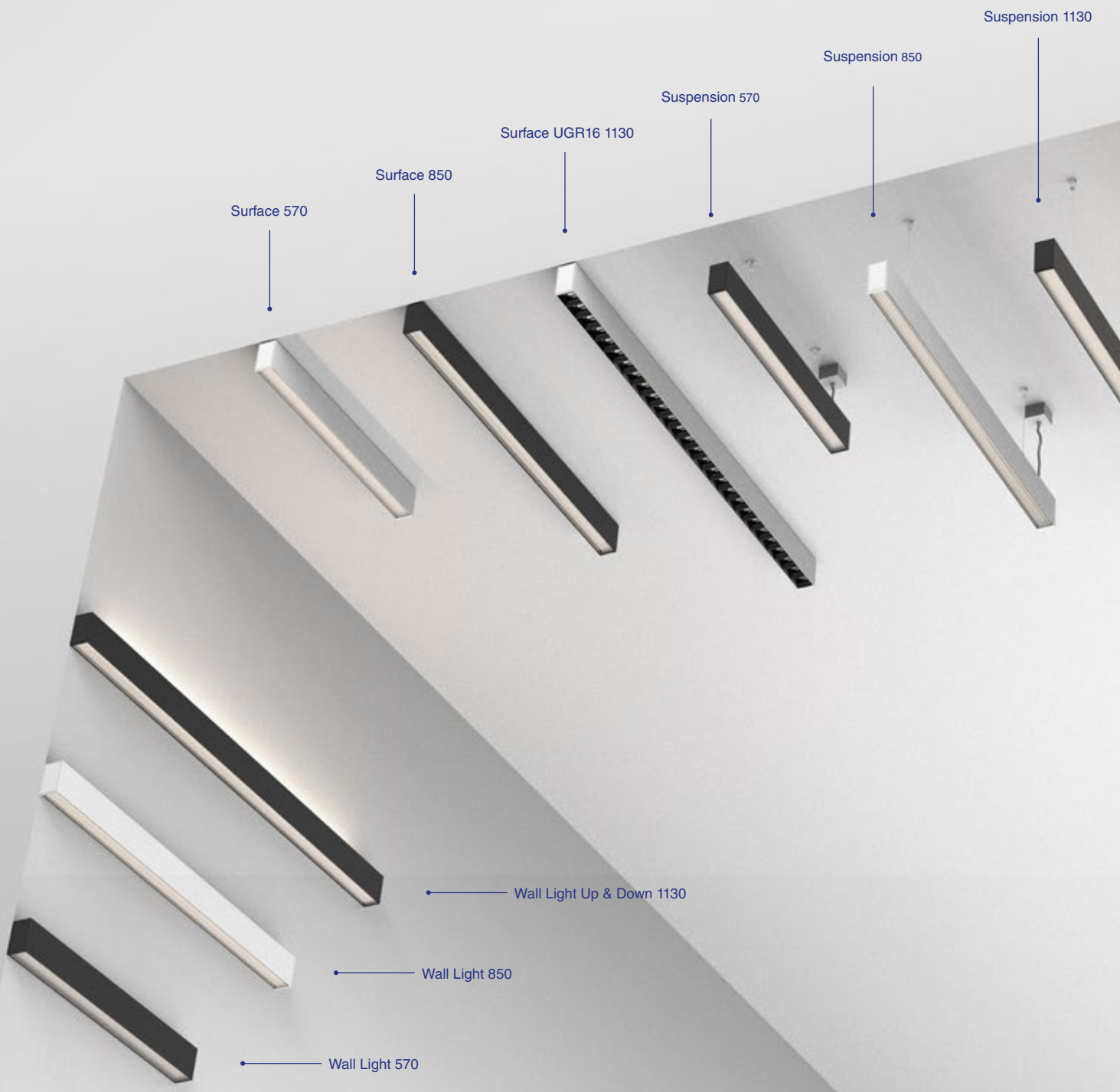

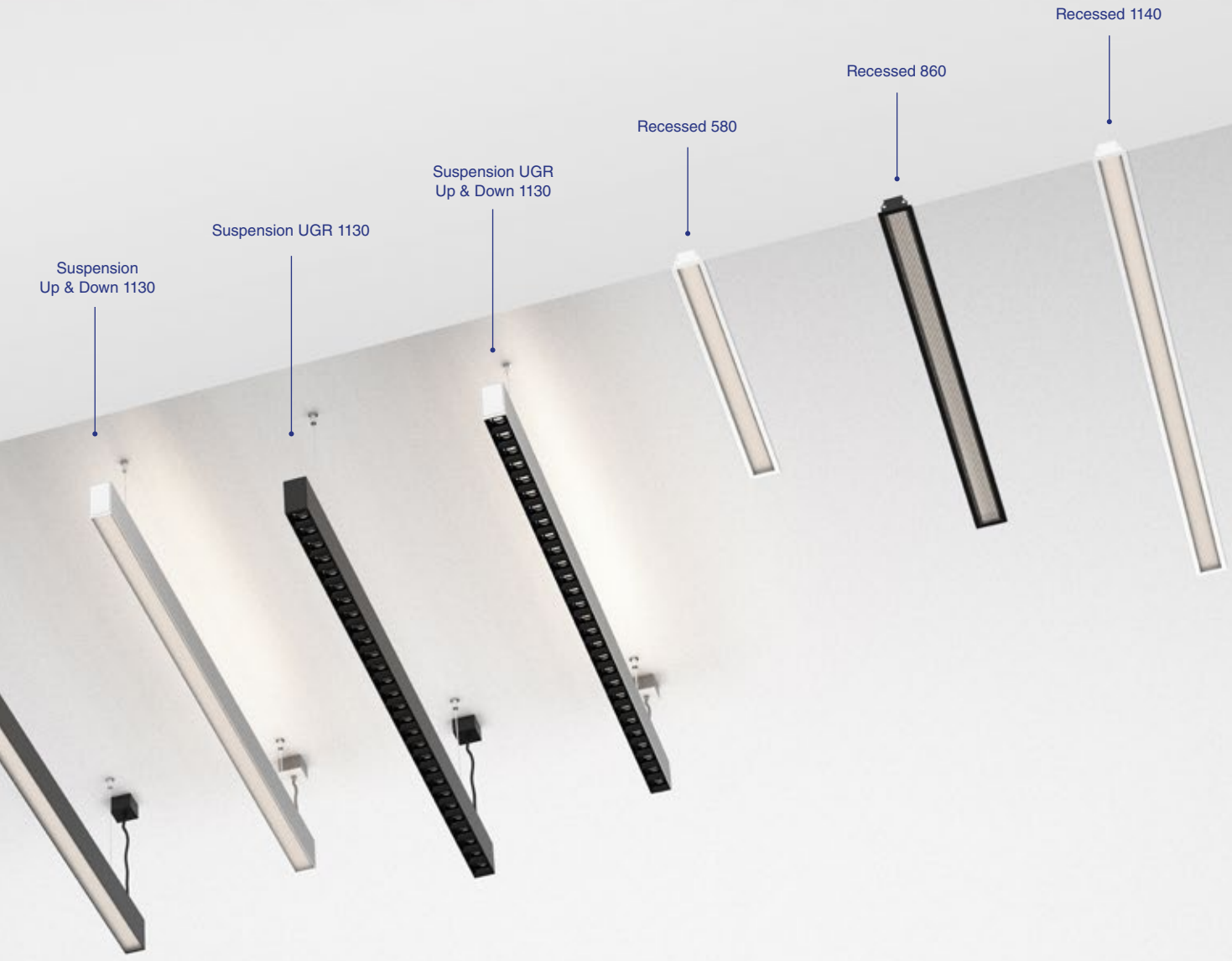

Suspension
Up & Down 1130

Suspension UGR 1130

Suspension UGR
Up & Down 1130

Recessed 580

Recessed 860

Recessed 1140

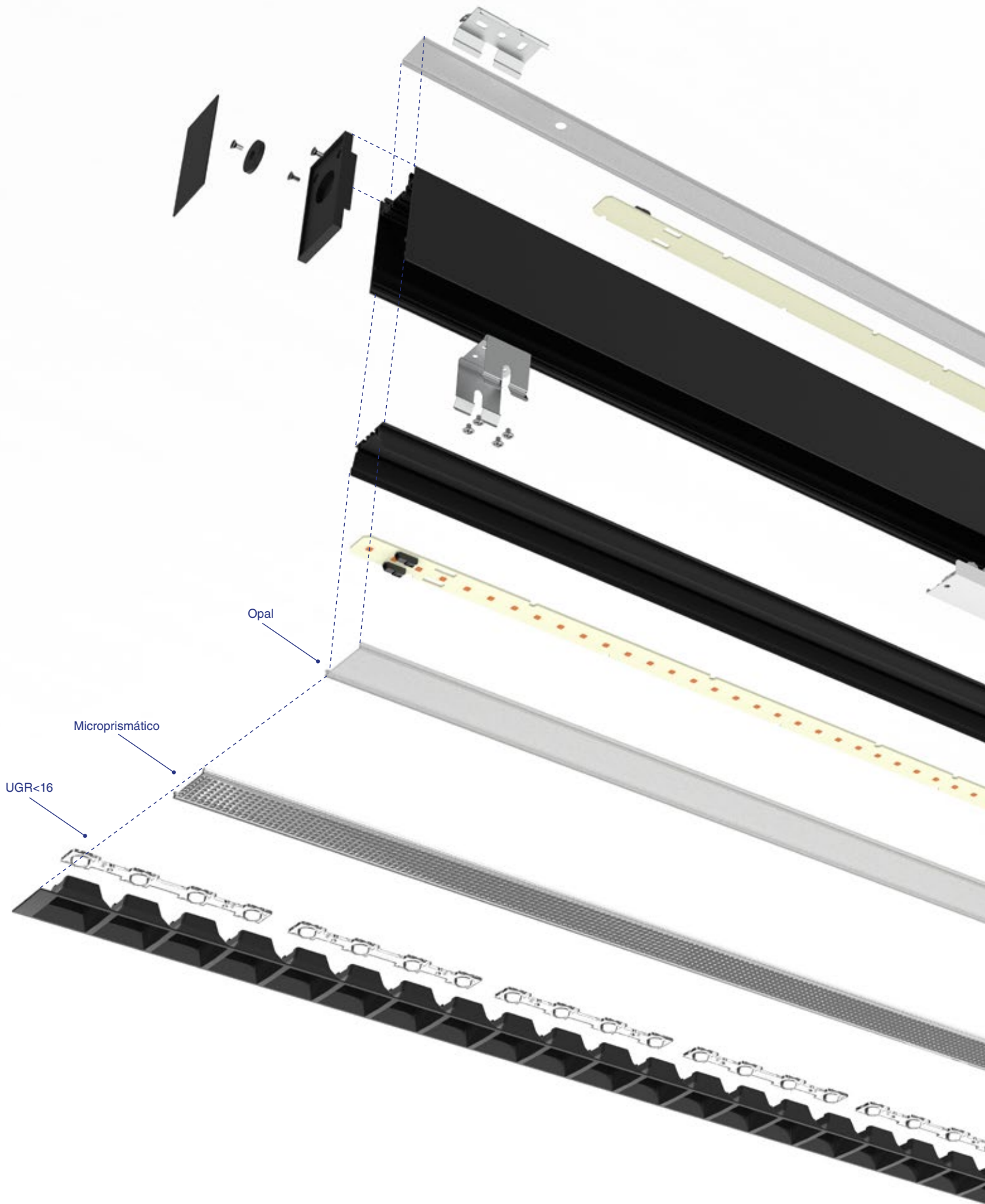

CONFIGURE YOUR

VIA

Also for your mobile phone
También para tu teléfono móvil

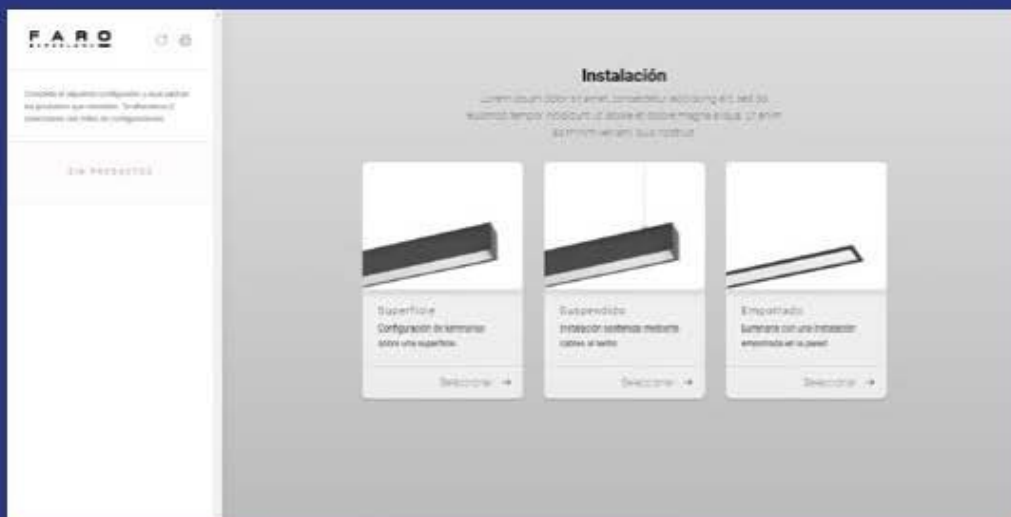
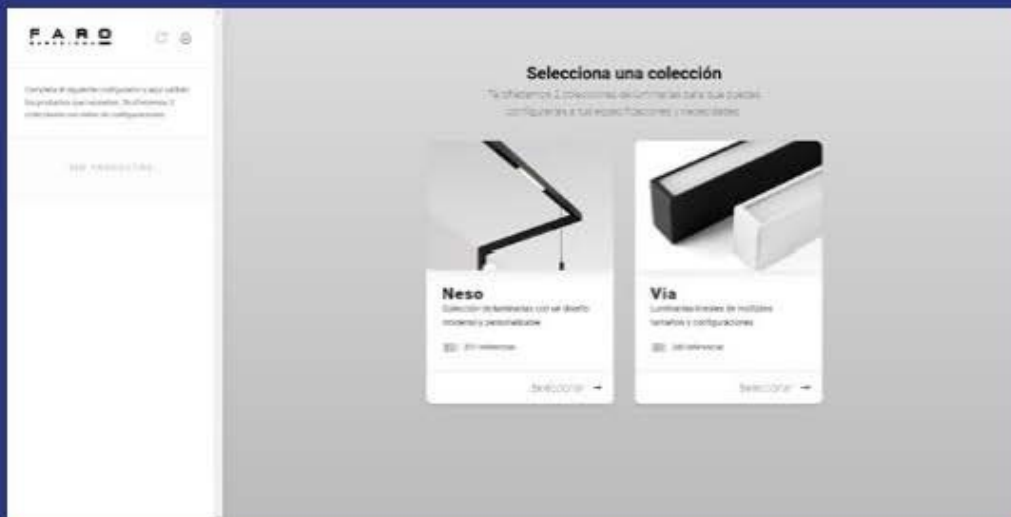



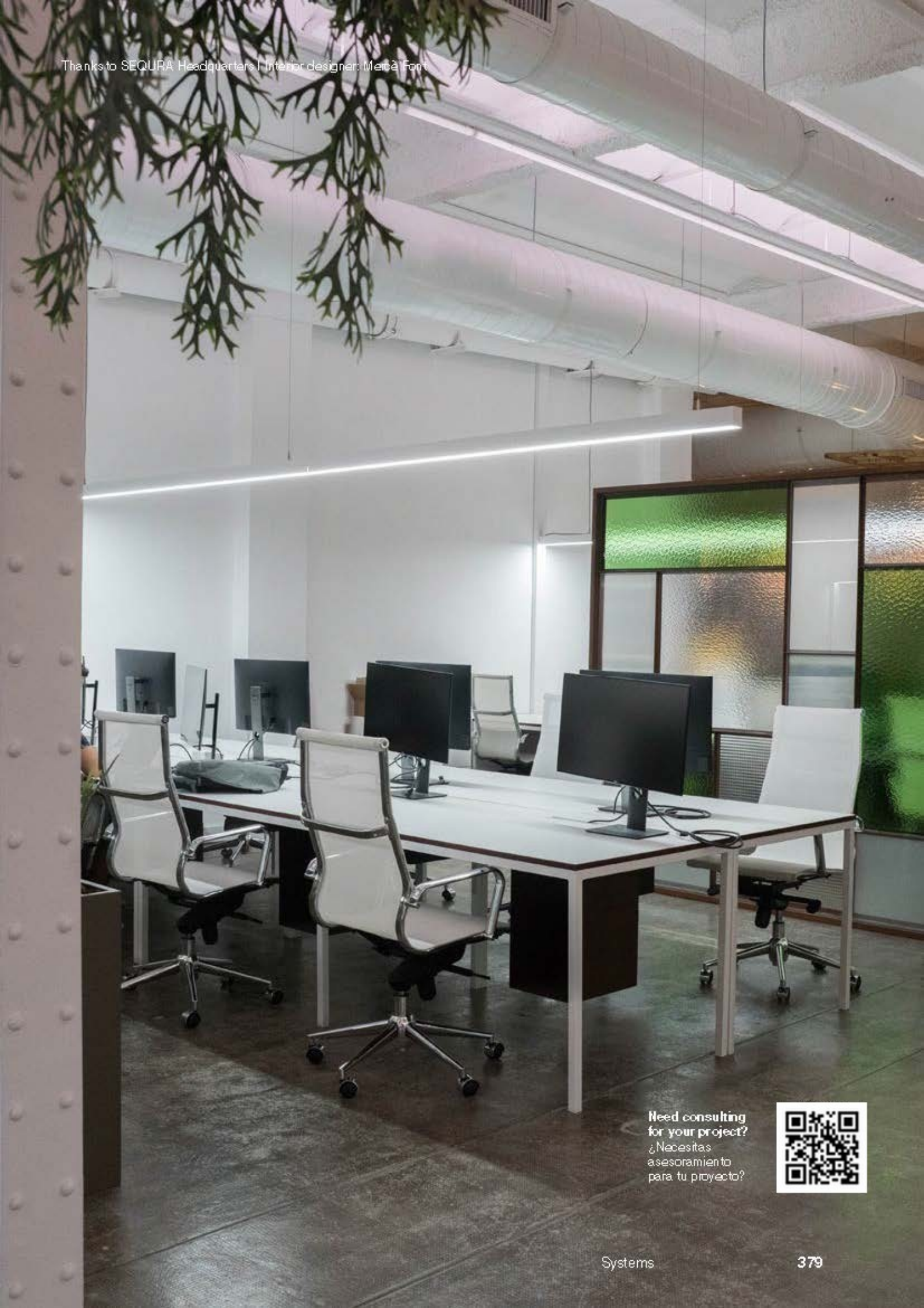

**Need consulting
for your project?**
¿Necesitas
asesoramiento
para tu proyecto?





Pendant Accessory



Pendant Accessory Dali



Continuous Accessory Surface (1 pcs)



Suspension Wire (2 pcs)



L-Shape without light



End Line Sensor



Middle Line Sensor

Accessories

	Pendant Accessory	Pendant Accessory Dali	L-Shape Without Light	Continuous Accessory Surface	Suspension Wire	End Line Sensor	Middle Line Sensor
●	040000093	040000095	040000091	040000097	040000098	040000089	040000101
●	040000094	040000096	040000090			040000099	040000100



Residential



Office



Microprisma

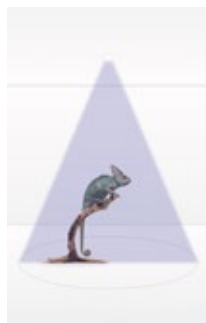

90°



Opal

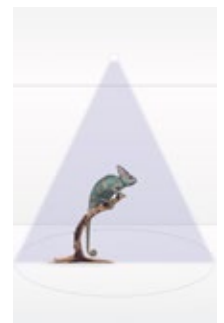

110°



UGR

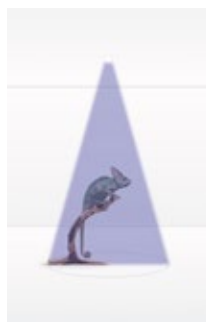

50°

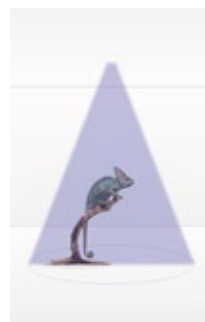

80°

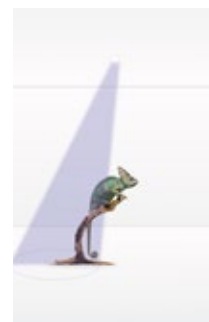

Asym°

VIA SURFACE & SUSPENSION 570

incl. DIM 50.000hs L80/B10 MacAdam 3 TW 220-240V 50 / 60Hz 650°C

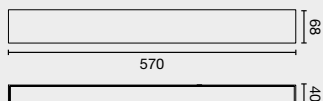

Family	Power	Finish	Control System	Diffuser
04100 Via Evo	590	Surface 15W 3000K CRI80	ON/OFF	Opal
	570	Surface 25W 3000K CRI80	W CASAMBI	U Microprisma
	680	Surface 15W 4000K CRI80	D DALI	
	660	Surface 25W 4000K CRI80		
04101 Via Evo	010	Surface 27W 2700-6500K TW	W CASAMBI	Opal
			D DALI	U Microprisma

04100

570

1

W

Example **041005701W** — Via Evo Surface 570 mm 25W 3000K Opal White

VIA SURFACE & SUSPENSION 850

incl. DIM 50.000hs L80/B10 MacAdam 3 TW 220-240V 50 / 60Hz 850°C

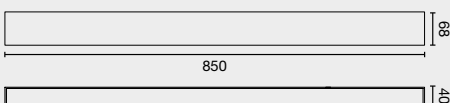

Family	Power	Finish	Control System	Diffuser
04100 Via Evo	560	Surface 20W 3000K CRI80	ON/OFF	Opal
	540	Surface 38W 3000K CRI80	W CASAMBI	U Microprisma
	650	Surface 20W 4000K CRI80	D DALI	
	630	Surface 38W 4000K CRI80		
04101 Via Evo	030	Surface 39W 2700-6500K TW	W CASAMBI	Opal
			D DALI	U Microprisma

VIA SURFACE & SUSPENSION 1130

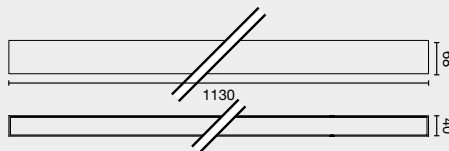
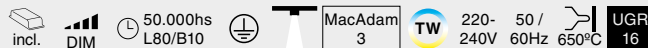

Family	Power	Finish	Control System	Diffuser
04100 Via Evo	530 Surface 27W 3000K CRI80	1 White	ON/OFF	Opal
	510 Surface 51W 3000K CRI80	2 Black	W CASAMBI	U Microprisma
	620 Surface 27W 4000K CRI80		D DALI	
	600 Surface 51W 4000K CRI80			
	N LF Surface Leaf 33W			
04101 Via Evo	050 Surface 48W 2700-6500K TW	1 White	W CASAMBI	Opal
		2 Black	D DALI	U Microprisma
04102 Via Evo	110 Surface UGR 32W 3000K CRI80	1 White	ON/OFF	8 UGR<19 80°
	120 Surface UGR 32W 4000K CRI80	2 Black	W CASAMBI	5 UGR<16 50°
	111 Surface UGR 17W 3000K CRI80		D DALI	0 UGR<19 asim.
	121 Surface UGR 17W 4000K CRI80			
04103 Via Evo	010 Surface UGR 54W 2700-6500K TW	1 White	W CASAMBI	8 UGR<19 80°
		2 Black	D DALI	5 UGR<16 50° 0 UGR<19 asim.

VIA L-SHAPE

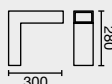
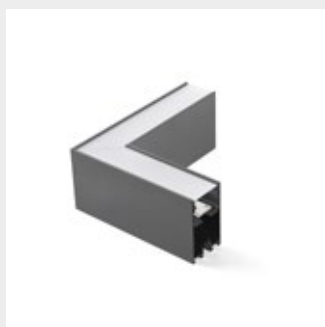

Accessory	Power	Finish	Control System	Diffuser
04100 L-shape	961 3000K 15W	1 White	ON/OFF	Opal
	971 4000K 15W	2 Black	W CASAMBI	U Microprisma
	981 3000K 25W		D DALI	
	991 4000K 25W			
04100 L-shape	951 TW 27W	1 White	W CASAMBI	Opal
		2 Black	D DALI	U Microprisma

Combine different VIA models. See colours to check compatibility of models in "L" installations or continuous lines.

Combina distintos modelos de VIA. Mira los colores para verificar las compatibilidades de modelos en instalaciones en "L" o líneas continuas.



VIA UP&DOWN 850

*Always order Suspension Kit
*Siempre pedir Kit de suspensión

incl. DIM 50.000hs L80/B10 MacAdam 3 TW 220-240V 50 / 60Hz 650°C

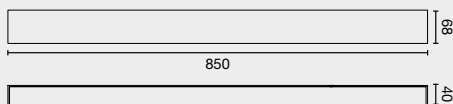

Family	Power	Finish	Control System	Diffuser
04200 Via Evo	540	Up&down 14+38W 3000K CRI80	ON/OFF	Opal
	630	Up&down 14+38W 4000K CRI80	W CASAMBI D DALI	U Microprisma
		1 White 2 Black		

VIA UP&DOWN 1130

*Always order Suspension Kit
*Siempre pedir Kit de suspensión

incl. DIM 50.000hs L80/B10 MacAdam 3 TW 220-240V 50 / 60Hz 650°C

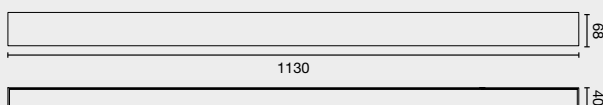

Family	Power	Finish	Control System	Diffuser
04200 Via Evo	510	Up&down 21+51W 3000K CRI80	ON/OFF	Opal
	600	Up&down 21+51W 4000K CRI80	W CASAMBI D DALI	U Microprisma
		1 White 2 Black		

VIA UP&DOWN UGR 1130

*Always order Suspension Kit
 *Siempre pedir Kit de suspensión







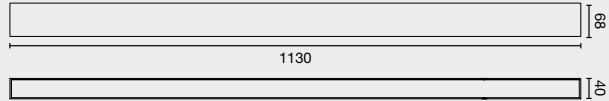

Family	Power	Finish	Control System	Diffuser
04202 Via Evo	110	Up&down UGR 24+32W 3000K CRI80	ON/OFF	8 UGR<19 80°
	120	Up&down UGR 24+32W 4000K CRI80	W CASAMBI D DALI	5 UGR<16 50° 0 UGR<19 asim.

VIA RECESSED 580

incl. DIM 50.000hs L80/B10 MacAdam 3 TW 220-240V 50 / 60Hz 650°C

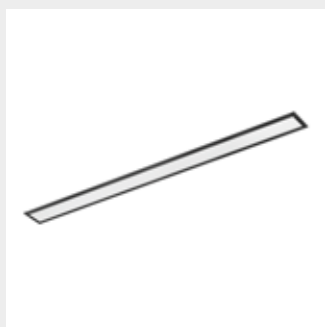

574x50

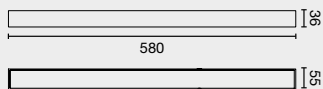

Family	Power	Finish	Control System	Diffuser
04100 Via Evo	770	Recessed 15W 3000K CRI80	ON/OFF	Opal
	750	Recessed 25W 3000K CRI80	W CASAMBI	U Microprisma
	800	Recessed 15W 4000K CRI80	D DALI	
	780	Recessed 25W 4000K CRI80		
04101 Via Evo	020	Recessed 27W 2700-6500K TW	W CASAMBI	Opal
			D DALI	U Microprisma

VIA RECESSED 860

incl. DIM 50.000hs L80/B10 MacAdam 3 TW 220-240V 50 / 60Hz 650°C

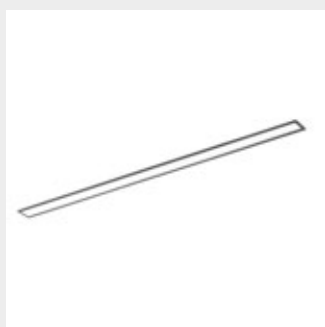

854x50

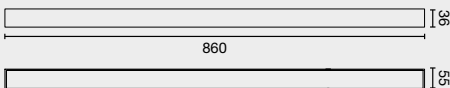

Family	Power	Finish	Control System	Diffuser
04100 Via Evo	0830	Recessed 20W 3000K CRI80	ON/OFF	Opal
	0810	Recessed 38W 3000K CRI80	W CASAMBI	U Microprisma
	0860	Recessed 20W 4000K CRI80	D DALI	
	0840	Recessed 38W 4000K CRI80		
04101 Via Evo	040	Recessed 39W 2700-6500K TW	W CASAMBI	Opal
			D DALI	U Microprisma

VIA RECESSED 1140

incl. DIM 50.000hs L80/B10 MacAdam 3 TW 220-240V 50 / 60Hz 650°C



1134x50

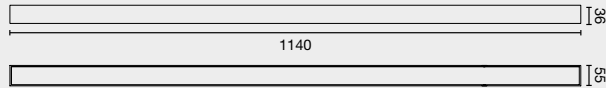

Family	Power	Finish	Control System	Diffuser
04100 Via Evo	0890 Recessed 27W 3000K CRI80	1 White	ON/OFF	Opal
	0870 Recessed 51W 3000K CRI80	2 Black	W CASAMBI	U Microprisma
	0920 Recessed 27W 4000K CRI80		D DALI	
	0900 Recessed 51W 4000K CRI80			
04101 Via Evo	060 Recessed 48W 2700-6500K TW	1 White	W CASAMBI	Opal
		2 Black	D DALI	U Microprisma

VIA WALL LIGHT 570

incl. DIM 50.000hs L80/B10 MacAdam 3 TW 220-240V 50 / 60Hz 650°C

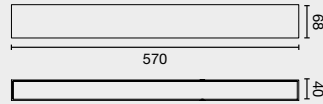

Family	Power	Finish	Control System	Diffuser
04100 Via Evo	595	Wall Light 15W 3000K CRI80	ON/OFF	Opal
	575	Wall Light 25W 3000K CRI80	W CASAMBI	
	685	Wall Light 15W 4000K CRI80	D DALI	
	665	Wall Light 25W 4000K CRI80		
04101 Via Evo	015	Wall Light 27W 2700-6500K TW	W CASAMBI	Opal
			D DALI	

VIA WALL LIGHT 850

incl. DIM 50.000hs L80/B10 MacAdam 3 TW 220-240V 50 / 60Hz 650°C

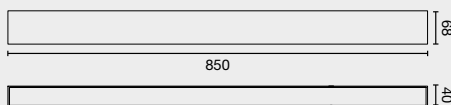

Family	Power	Finish	Control System	Diffuser
04100 Via Evo	565	Wall Light 20W 3000K CRI80	ON/OFF	Opal
	545	Wall Light 38W 3000K CRI80	W CASAMBI	
	655	Wall Light 20W 4000K CRI80	D DALI	
	635	Wall Light 38W 4000K CRI80		
04101 Via Evo	035	Wall Light 39W 2700-6500K TW	W CASAMBI	Opal
			D DALI	

VIA WALL LIGHT 1130

incl. DIM 50.000hs L80/B10 MacAdam 3 TW 220-240V 50 / 60Hz 650°C

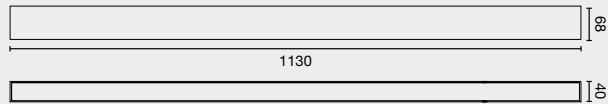

Family	Power	Finish	Control System	Diffuser
04100 Via Evo	535 Wall Light 27W 3000K CRI80	1 White	ON/OFF	Opal
	515 Wall Light 51W 3000K CRI80	2 Black	W CASAMBI	
	625 Wall Light 27W 4000K CRI80		D BALI	
	605 Wall Light 51W 4000K CRI80			
04101 Via Evo	055 Wall Light 48W 2700-6500K TW	1 White	W CASAMBI	Opal
		2 Black	BALI	
N 04104 Via Evo	LF Wall Leaf 33W	1 White	ON/OFF	Opal
		2 Black	W CASAMBI	U Microprisma
			D BALI	

VIA WALL LIGHT UP&DOWN 850

incl. DIM 50.000hs L80/B10 MacAdam 3 TW 220-240V 50 / 60Hz 650°C

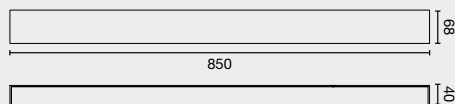

Family	Power		Finish	Control System	Diffuser
04200	Via Evo	545	Wall Light Up&Down 14+38W 3000K CRI80	<input type="checkbox"/> ON/OFF <input checked="" type="checkbox"/> W CASAMBI <input checked="" type="checkbox"/> D DALI	<input type="checkbox"/> Opal
		635	Wall Light Up&Down 14+38W 4000K CRI80		
04201	Via Evo	035	Wall Light Up&Down 9+39W 2700-6500K TW	<input checked="" type="checkbox"/> W CASAMBI <input type="checkbox"/> DALI	<input type="checkbox"/> Opal

VIA WALL LIGHT UP&DOWN 1130

incl. DIM 50.000hs L80/B10 MacAdam 3 TW 220-240V 50 / 60Hz 650°C

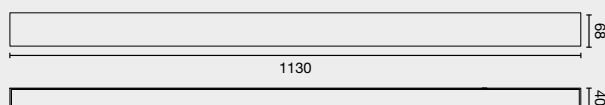

Family	Power		Finish	Control System	Diffuser
04200	Via Evo	515	Wall Light Up&Down 21+51W 3000K CRI80	<input type="checkbox"/> ON/OFF <input checked="" type="checkbox"/> W CASAMBI <input checked="" type="checkbox"/> D DALI	<input type="checkbox"/> Opal
		605	Wall Light Up&Down 21+51W 4000K CRI80		
04201	Via Evo	055	Wall Light Up&Down 18+49W 2700-6500K TW	<input checked="" type="checkbox"/> W CASAMBI <input type="checkbox"/> DALI	<input type="checkbox"/> Opal

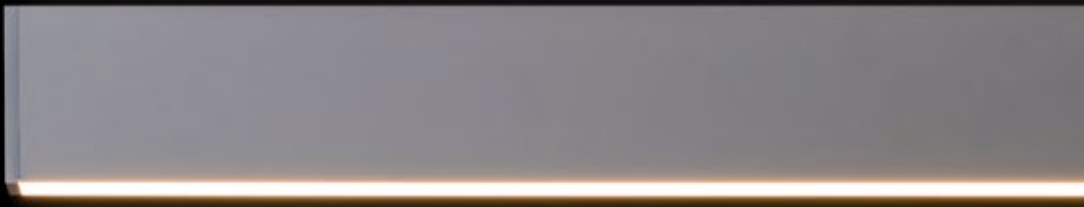

VIA SURFACE & SUSPENSION

570mm						
Option	Color T°	CRI	Difusor	Power	Lumen Output	Beam Angle
590	3000K	80	Opal / Microprisma	15W	1392lm / 1133lm	110° / 90°
570		80	Opal / Microprisma	25W	2506m / 2039m	110° / 90°
680	4000K	80	Opal / Microprisma	15W	1434lm / 1167lm	110° / 90°
660		80	Opal / Microprisma	25W	2581lm / 2100lm	110° / 90°
010	2700-6500K	TW	Opal / Microprisma	27W	1964lm / 1598lm	110° / 90°
850mm						
Option	Color T°	CRI	Difusor	Power	Lumen Output	Beam Angle
560	3000K	80	Opal / Microprisma	20W	2131lm / 1735lm	110° / 90°
540		80	Opal / Microprisma	38W	3809lm / 3121lm	110° / 90°
650	4000K	80	Opal / Microprisma	20W	2195lm / 1787lm	110° / 90°
630		80	Opal / Microprisma	39W	3923lm / 3214lm	110° / 90°
010	2700-6500K	TW	Opal / Microprisma	39W	2985lm / 2429lm	110° / 90°
1130mm						
Option	Color T°	CRI	Difusor	Power	Lumen Output	Beam Angle
530	3000K	80	Opal / Microprisma	27W	2842lm / 2313lm	110° / 90°
510		80	Opal / Microprisma	51W	5112lm / 4161lm	110° / 90°
620	4000K	80	Opal / Microprisma	27W	2927lm / 2382lm	110° / 90°
600		80	Opal / Microprisma	51W	5265lm / 4286lm	110° / 90°
050	2700-6500K	TW	Opal / Microprisma	48W	4006lm / 3261lm	110° / 90°
110	3000K	80	UGR<16 / UGR<19	32W	3989lm / 4104lm / 3739lm	50° / 80° / Asym
120	4000K	80	UGR<16 / UGR<19	32W	4109lm / 4227lm / 3851lm	50° / 80° / Asym
010	2700-6500K	TW	UGR<16 / UGR<19	54W	4830lm / 4881lm / 4467lm	50° / 80° / Asym

VIA UP&DOWN

850mm						
Option	Color T°	CRI	Difusor	Power	Lumen Output	Beam Angle
540	3000K	80	Opal / Microprisma	14 + 38W	1240 + 3809lm / 1323 + 3121lm	110° / 90°
630	4000K	80	Opal / Microprisma	14 + 38W	1278 + 3923lm / 1363 + 3214lm	110° / 90°
030	2700-6500K	TW	Opal / Microprisma	9 + 39W	720 + 2985lm / 738 + 2429lm	110° / 90°
1130mm						
Option	Color T°	CRI	Difusor	Power	Lumen Output	Beam Angle
510	3000K	80	Opal / Microprisma	21 + 51W	2794 + 5112lm / 2794 + 4161lm	110° / 90°
600	4000K	80	Opal / Microprisma	21 + 51W	2878 + 5265lm / 2878 + 4286lm	110° / 90°
050	2700-6500K	TW	Opal / Microprisma	18 + 48W	2395 + 4006lm / 2395 + 3261lm	110° / 90°
1130mm						
Option	Color T°	CRI	Difusor	Power	Lumen Output	Beam Angle
110	3000K	80	UGR<16 / UGR<19	24 + 32W	2794 + 3989lm / 2794 + 4104lm / 2794 + 3739lm	50° / 80° / Asym
120	4000K	80	UGR<16 / UGR<19	24 + 32W	2878 + 4109lm / 2878 + 4227lm / 2878 + 3851lm	50° / 80° / Asym
010	2700-6500K	TW	UGR<16 / UGR<19	18 + 54W	2395 + 4830lm / 2395 + 4881lm / 2395 + 4467lm	50° / 80° / Asym

VIA WALL LIGHT UP&DOWN

850mm						
Option	Color T°	CRI	Difusor	Power	Lumen Output	Beam Angle
545	3000K	80	Opal	14+38W	1240 + 3809lm	110°
635	4000K	80	Opal	14+38W	1278 + 3923lm	110°
035	2700-6500K	TW	Opal	9+39W	720 + 2985lm	110°
1130mm						
Option	Color T°	CRI	Difusor	Power	Lumen Output	Beam Angle
515	3000K	80	Opal	21+51W	2794 + 5112lm	110°
605	4000K	80	Opal	21+51W	2878 + 5265lm	110°
055	2700-6500K	TW	Opal	18+48W	2395 + 4006lm	110°

VIA RECESSED

580mm						
Option	Color T°	CRI	Difusor	Power	Lumen Output	Beam Angle
770	3000K	80	Opal / Microprisma	15W	1392lm / 1133lm	110° / 90°
750		80	Opal / Microprisma	25W	2506m / 2039m	110° / 90°
800	4000K	80	Opal / Microprisma	15W	1434lm / 1167lm	110° / 90°
780		80	Opal / Microprisma	25W	2581lm / 2100lm	110° / 90°
020	2700-6500K	TW	Opal / Microprisma	27W	1964lm / 1598lm	110° / 90°
860mm						
0830	3000K	80	Opal / Microprisma	20W	2131lm / 1735lm	110° / 90°
0810		80	Opal / Microprisma	38W	3809lm / 3121lm	110° / 90°
0860	4000K	80	Opal / Microprisma	20W	2195lm / 1787lm	110° / 90°
0840		80	Opal / Microprisma	38W	3923lm / 3214lm	110° / 90°
040	2700-6500K	TW	Opal / Microprisma	39W	2985lm / 2429m	110° / 90°
1140mm						
0890	3000K	80	Opal / Microprisma	27W	2842lm / 2313lm	110° / 90°
0870		80	Opal / Microprisma	51W	5112lm / 4161lm	110° / 90°
0920	4000K	80	Opal / Microprisma	27W	2927lm / 2382lm	110° / 90°
0900		80	Opal / Microprisma	51W	5265lm / 4286lm	110° / 90°
060	2700-6500K	TW	Opal / Microprisma	48W	4006lm / 3261lm	110° / 90°

VIA WALL LIGHT

570mm						
Option	Color T°	CRI	Difusor	Power	Lumen Output	Beam Angle
595	3000K	80	Opal	15W	1392lm	110°
575		80	Opal	25W	2506m	110°
685	4000K	80	Opal	15W	1434lm	110°
665		80	Opal	25W	2581lm	110°
015	2700-6500K	TW	Opal	27W	1964lm	110°
850mm						
565	3000K	80	Opal	20W	2131lm	110°
545		80	Opal	38W	3809lm	110°
655	4000K	80	Opal	20W	2195lm	110°
635		80	Opal	38W	3923lm	110°
035	2700-6500K	TW	Opal	39W	2985lm	110°
1130mm						
535	3000K	80	Opal	27W	2842lm	110°
515		80	Opal	51W	5112lm	110°
625	4000K	80	Opal	27W	2927lm	110°
605		80	Opal	51W	5265lm	110°
055	2700-6500K	TW	Opal	48W	4006lm	110°

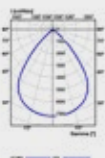

110°

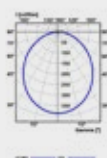

90°

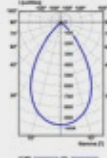

50°

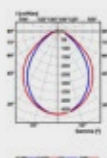

80°

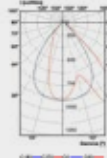

Asym°

FONOVIA is a concept of linear light that isolates us from the environment, creating moments of concentration thanks to its fabric with sound-absorbing properties that in turn softens the light creating spaces of well-being. It accompanies moments of concentration and privacy. Fabric that favours acoustic absorption. Ideal for crowded spaces and meeting rooms.

FONOVIA es un concepto de luz lineal que nos aísla del entorno, creando momentos de concentración gracias a su tejido con propiedades fonoabsorbentes que a su vez suaviza la luz creando espacios de bienestar. Acompaña los momentos de concentración y de privacidad. Tejido que favorece la absorción acústica. Ideal para espacios concurridos y salas de reunión.

DESIGNED BY FAROLAB

FONOVIA



Fonovia 156
25W

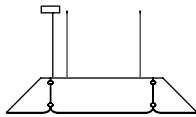

1560

Fonovia 240
50W

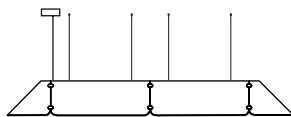

2400

Fonovia
Custom



FINISH
Acabado

● **Grey**
Gris

COLOR TEMPERATURE
Temperatura de color

3000K CRI>80

4000K CRI>80

Highlights

Recycled PET

Because polyester accounts for approximately 60 percent of the world's production of PET, developing a non-virgin supply chain for polyester fiber has the potential to massively impact global energy and resource requirements.

Debido a que el poliéster representa aproximadamente el 60 por ciento de la producción mundial de PET, el desarrollo de una cadena de suministro no virgen para la fibra de poliéster tiene el potencial de impactar masivamente los requerimientos globales de energía y recursos.



Sound Absorbing $\alpha = 0.9$

Noise in offices and workplaces has direct consequences on worker performance. The most immediate one is the reduction of their concentration. Workers exposed to continuous noise in their workplace are less effective in their work tasks. Concentration often means giving the brain a break to think better and focus on an activity. Luminaires made from fabrics with noise-absorbing properties are perfect for work spaces with high noise levels and acoustic distractions.

El ruido en las oficinas y lugares de trabajo tiene consecuencias directas en el rendimiento de los trabajadores. La más inmediata es la reducción de su concentración. Los trabajadores expuestos a un ruido continuo en su lugar de trabajo son menos eficaces en sus tareas. La concentración suele significar dar un respiro al cerebro para pensar mejor y centrarse en una actividad. Las luminarias fabricadas con tejidos con propiedades de absorción del ruido son perfectas para espacios de trabajo con altos niveles de ruido y distracciones acústicas.



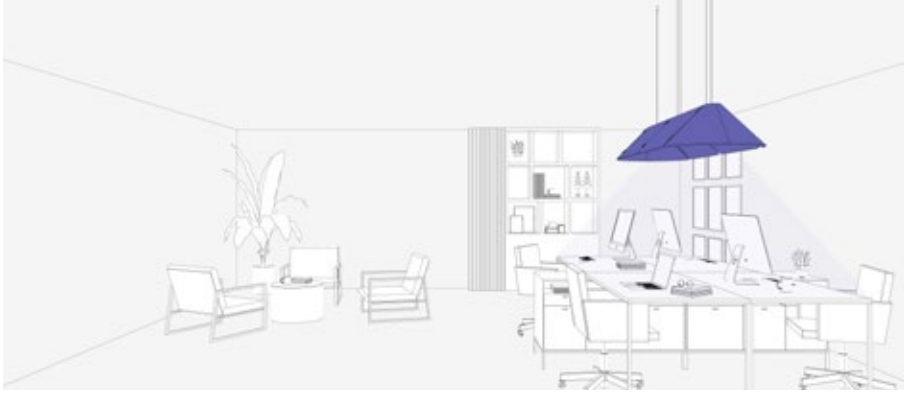

Office

Beam Angle



90°

FONOVIA 156cm 25W

incl. 50.000hs L80 / B10 MacAdam 3 220-240V 50 / 60Hz 650°C

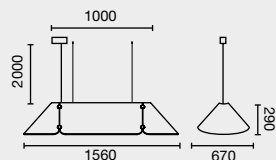

Reference	Finish	Power	Color T°	Lumen Output
20110	● Grey	25W	3000K CRI>80	1800lm
20109	● Grey	25W	4000K CRI>80	1900lm

FONOVIA 240cm 50W

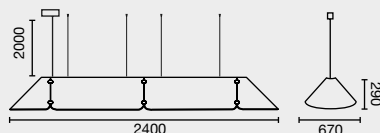

Reference	Finish	Power	Color T°	Lumen Output
20107	● Grey	50W	3000K CRI>80	3600lm
20108	● Grey	50W	4000K CRI>80	3800lm

Thanks to BEDEO relational/project



Need consulting
for your project?
¿Necesitas
asesoramiento
para tu proyecto?



CONFIGURE YOUR

FONOVIA



1 Choose your via pendant composition

Escoge tu composición de via colgante

VIA SURFACE & SUSPENSION 850



Family	Power	Finish	Control System	Diffuser
04100 Via Evo	560	Surface 20W 3000K CRI80	ON/OFF	Opal
	540	Surface 38W 3000K CRI80	W CASAMBI	U Microprisma
	650	Surface 20W 4000K CRI80	D DALI	
	630	Surface 38W 4000K CRI80		
04101 Via Evo	030	Surface 39W 2700-6500K TW	W CASAMBI	Opal
			D DALI	U Microprisma

VIA SURFACE & SUSPENSION 1130

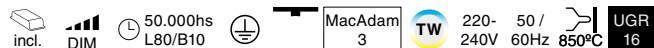

Family	Power	Finish	Control System	Diffuser
04100 Via Evo	530	Surface 27W 3000K CRI80	ON/OFF	Opal
	510	Surface 51W 3000K CRI80	W CASAMBI	U Microprisma
	620	Surface 27W 4000K CRI80	D DALI	
	600	Surface 51W 4000K CRI80		
	LF	Surface Leaf 33W		
04101 Via Evo	050	Surface 48W 2700-6500K TW	W CASAMBI	Opal
			D DALI	U Microprisma
04102 Via Evo	110	Surface UGR 32W 3000K CRI80	ON/OFF	8 UGR<19 80°
	120	Surface UGR 32W 4000K CRI80	W CASAMBI	5 UGR<16 50°
04103 Via Evo	010	Surface UGR 54W 2700-6500K TW	D DALI	0 UGR<19 asim.
			W CASAMBI	8 UGR<19 80°
			D DALI	5 UGR<16 50°
			0 UGR<19 asim.	

2 Choose your pendant accessory

Escoge tu accesorio colgante

Pendant Accessory	Pendant Accessory Dali
○ 04000093	04000095
● 04000094	04000096

3

Dress your VIA EVO SYSTEM with fonovia sound absorbing shade system
Viste tu SISTEMA VIA EVO con el sistema de pantallas fonoabsorbentes fonovia

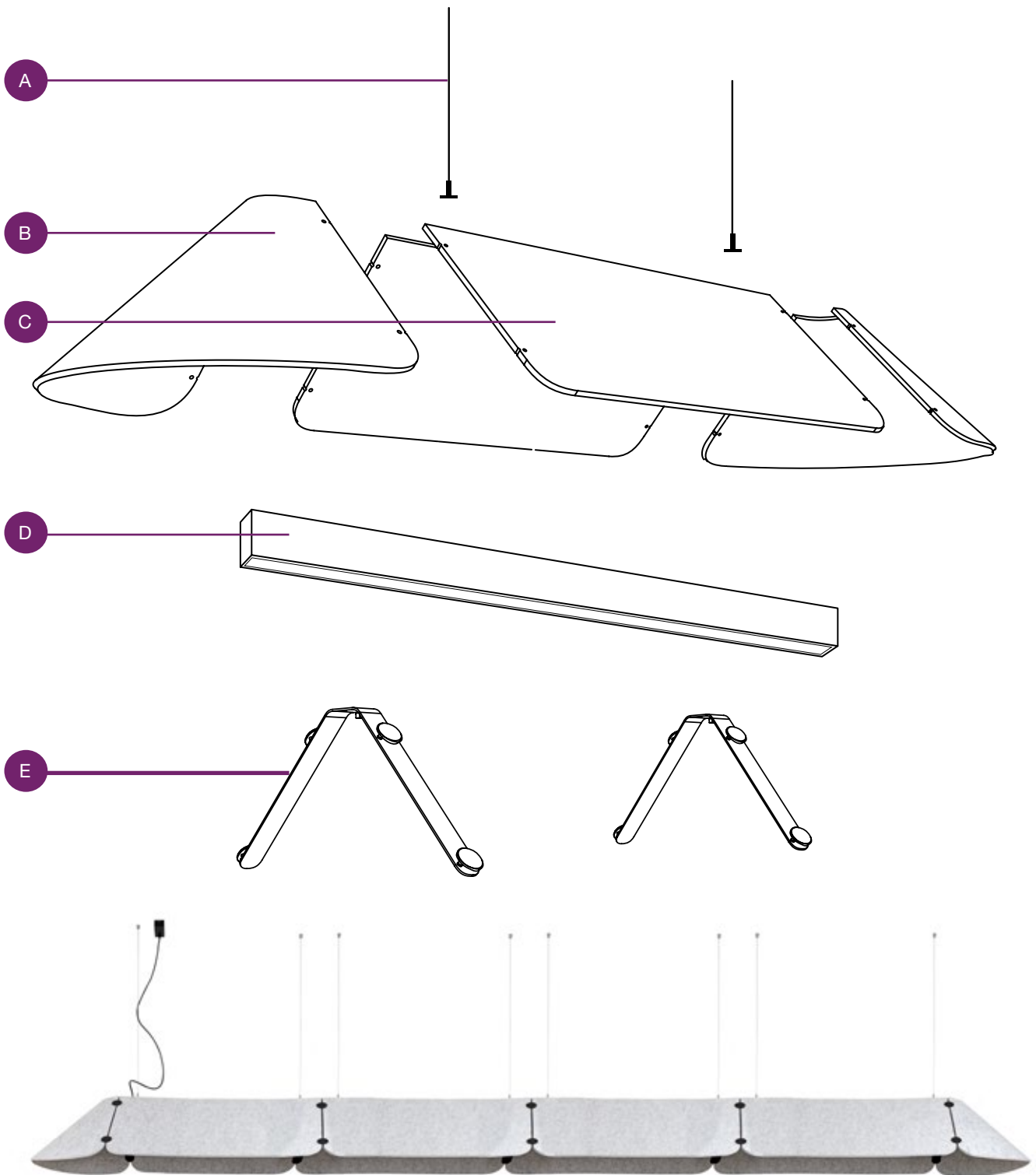

Example **041005601W** — 4pc. x Via Evo Surface 20W 3000K CRI80 White Casambi
041080001 — 4pc. x 2ud.Fonovia Panels 837x400x9
040000094 — 1pc. x Pendant Accessory Black
040000098 — 4pc. x Accessory wire suspension
041080004 — 5pc. x Kit Soporte Fonovia Negro
041080003 — 1pc. x 2 Paneles Fonovia Conics



A

Accessory wire suspension
Accesorio cables de suspensión
1pc.— 04000098
For each VIA EVO
Por cada VIA EVO

Pendant Accessory
Accesorio suspensión on/off
1pc.— ● 04000093
1pc.— ● 04000094
For each FONOVIA SYSTEM
Por cada FONOVIA SYSTEM

Pendant Accessory DALI
Accesorio suspensión on/off
1pc.— ● 04000095
1pc.— ● 04000096
For each FONOVIA SYSTEM
Por cada FONOVIA SYSTEM



B

For each complet system of VIA EVO
Para cada sistema completo de VIA EVO
1pc. — 041080003
2 Fonovia Conics Panels 359x664x9
2 Paneles Fonovia Conics 359x664x9



C

For each 850cm. VIA EVO
Por cada VIA EVO de 850cm.
1pc.— 041080001
2 Fonovia Panels 837x400x9 Light Grey
2 Paneles Fonovia 837x400x9 Gris Claro

For each 1130cm. VIA EVO
Por cada VIA EVO de 1130cm.
1pc. — 041080002
2 Fonovia Panels 1117x400x9 Light Grey Claro
2 Paneles Fonovia 1117x400x9 Gris



D

Choose your via pendant composition
Escoge tu composición de via colgante



E

041080004 — Kit Soporte Fonovia Negro
If you have 1 VIA EVO, use 2 supports.
If you have 2 VIA EVO, use 3 supports.
If you have 3 VIA EVO, use 4 supports.
(always one unit more than the number of tracks)

Si tienes 1 VIA EVO, usa 2 soportes.
Si tienes 2 VIA EVO, usa 3 soportes.
Si tienes 3 VIA EVO, usa 4 soportes.
(siempre una unidad mas que del numero de vías)



L E D S T R I P



LED STRIP
Tiras Led

MONOCHROMATIC
Monocolor

COB

IP67 NEON

5 W	15 W	Tunable White	Neon IP67
9,6 W	19,2 W	RGB	

INDEX PROTECTION
Índice de protección

IP20	IP66	IP67
------	------	------

COLOR TEMPERATURE
Temperatura de color

2700K CRI80	3000K CRI80	4000K CRI80	2700-6500K	RGB	RGBW	
-------------	-------------	-------------	------------	-----	------	--

PROFILE
Perfiles

RECESSED
Empotrables

SURFACE
Superficie

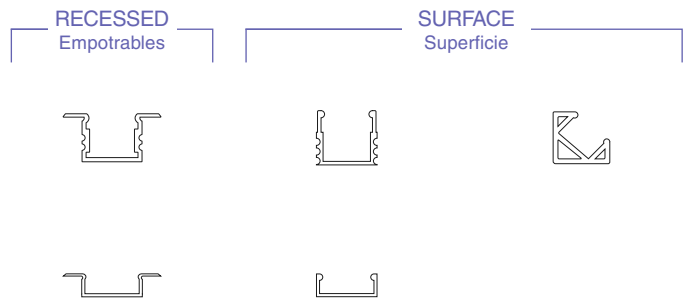

FINISH
Acabado

Black
Negro

White
Blanco

Silver
Plateado

DIFFUSER
Difusor

Transparent

Opal



Thanks to EMMME Studio | Photo by Lupe Clemente



LEDSTRIP MONOCHROMATIC 5W/m

NEW

no incl.  5mt.  DIM  MacAdam 3  24V CRI>80

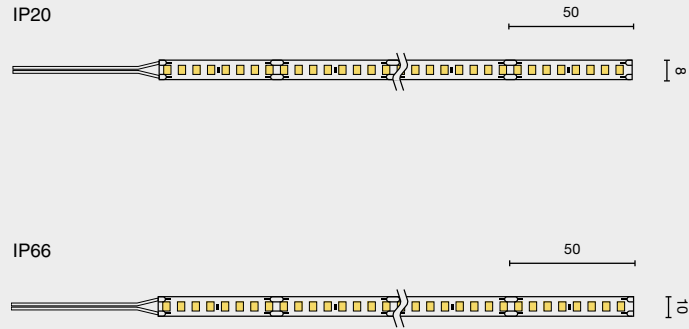

Ref	Power (W/m)	Color T°	lm output/m	LED/m	IP	Cut
08050306	5W	2700K	700	160 led/m	20	50 mm
08050307	5W	3000K	725	160 led/m	20	50 mm
08050308	5W	4000K	775	160 led/m	20	50 mm
08050901	5W	2700K	625	160 led/m	66	50 mm
08050902	5W	3000K	650	160 led/m	66	50 mm
08050903	5W	4000K	675	160 led/m	66	50 mm

*Roll of 5m (500cm). You can order your own custom length every 10cm.
Cut to measure: ref. -XX, where XX=length (-01=0,1m, -02=0,2m, -14=1,4m...)

* Bobina de 5m (500cm) de longitud. Puede pedir su propia longitud personalizada cada 10cm.
Corte a medida: ref. -XX, donde XX=longitud (-01=0,1m, -02=0,2m, -14=1,4m...)

LEDSTRIP MONOCHROMATIC 9.6W/m

no incl.  5mt.  DIM  MacAdam 3  24V CRI>80

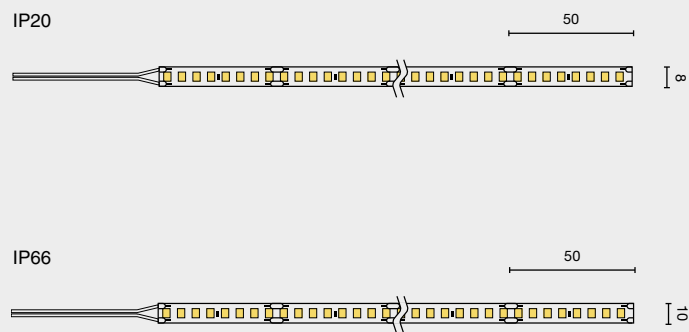

Ref	Power (W/m)	Color T°	lm output/m	LED/m	IP	Cut
08050106	9.6W	2700K	1300	160 led/m	20	50 mm
08050107	9.6W	3000K	1320	160 led/m	20	50 mm
08050108	9.6W	4000K	1360	160 led/m	20	50 mm
08050301	9.6W	2700K	1300	160 led/m	66	50 mm
08050302	9.6W	3000K	1320	160 led/m	66	50 mm
08050303	9.6W	4000K	1360	160 led/m	66	50 mm

*Roll of 5m (500cm). You can order your own custom length every 10cm.
Cut to measure: ref. -XX, where XX=length (-01=0,1m, -02=0,2m, -14=1,4m...)

* Bobina de 5m (500cm) de longitud. Puede pedir su propia longitud personalizada cada 10cm.
Corte a medida: ref. -XX, donde XX=longitud (-01=0,1m, -02=0,2m, -14=1,4m...)



LEDSTRIP MONOCHROMATIC 15W/m NEW

no incl.  5mt.  DIM  MacAdam 3  24V CRI>80

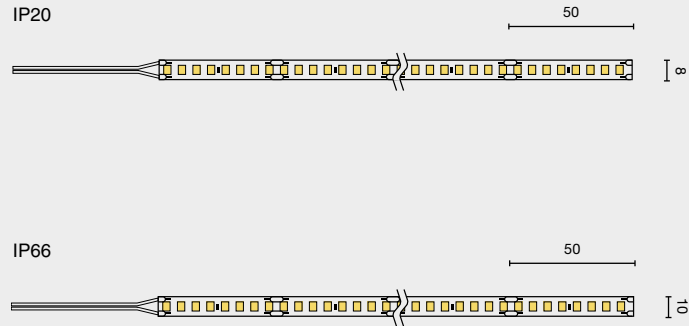

Ref	Power (W/m)	Color T°	lm output/m	LED/m	IP	Cut
08050406	15W	2700K	2025	160 led/m	20	50 mm
08050407	15W	3000K	2070	160 led/m	20	50 mm
08050408	15W	4000K	2175	160 led/m	20	50 mm
08050801	15W	2700K	1800	160 led/m	66	50 mm
08050802	15W	3000K	1845	160 led/m	66	50 mm
08050803	15W	4000K	1950	160 led/m	66	50 mm

*Roll of 5m (500cm). You can order your own custom length every 10cm.
Cut to measure: ref. -XX, where XX=length (-01=0,1m, -02=0,2m, -14=1,4m...)

* Bobina de 5m (500cm) de longitud. Puede pedir su propia longitud personalizada cada 10cm.
Corte a medida: ref. -XX, donde XX=longitud (-01=0,1m, -02=0,2m, -14=1,4m...)

LEDSTRIP MONOCHROMATIC 19.2W/m

no incl.  5mt.  DIM  MacAdam 3  24V CRI>80



Ref	Power (W/m)	Color T°	lm output/m	LED/m	IP	Cut
08050201	19.2W	2700K	2500	192 led/m	20	41,67 mm
08050202	19.2W	3000K	2520	192 led/m	20	41,67 mm
08050203	19.2W	4000K	2600	192 led/m	20	41,67 mm
08050401	19.2W	2700K	2500	192 led/m	66	41,67 mm
08050402	19.2W	3000K	2520	192 led/m	66	41,67 mm
08050403	19.2W	4000K	2600	192 led/m	66	41,67 mm

*Roll of 5m (500cm). You can order your own custom length every 12,5cm.
Cut to measure: ref. -XXXX, where XXXX=length (-0115=0,125m, -1000 =1m ...)

* Bobina de 5m (500cm) de longitud. Puede pedir su propia longitud personalizada cada 12,5cm
Corte a medida: ref. -XXXX, donde XXXX=longitud (-0125=0,125m, -1000 =1m ...)

ACCESSORIES

08050696	UNION ACCESSORY LED STRIP 8mm	Accesorio unión tira led 8mm
08050697	UNION ACCESSORY LED STRIP 10mm	Accesorio unión tira led 10mm
08050698	CONNECTOR CABLE ACCESSORY LED STRIP 8mm	Accesorio conector cable tira led 8mm
08050699	CONNECTOR CABLE ACCESSORY LED STRIP 10mm	Accesorio conector cable tira led 10mm



LEDSTRIP COB TUNABLE WHITE

no incl.  5mt.  DIM  24V  CRI>90  TW 

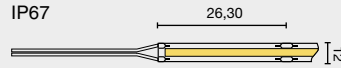
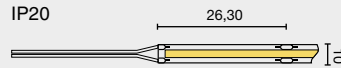

Ref	Power (W/m)	Color T°	lm output/m	IP	Cut
08050501	12W + 12W	2700-6500K	1080 + 1248	20	26,3 mm
08050511	12W + 12W	2700-6500K	1080 + 1248	67	26,3 mm

*Roll of 5m (500cm). You can order your own custom lenght every 10,5cm.
Cut to measure: ref. -XXX, where XXX=length (-0105=0,105m, -1052 =1,052m ...)

* Bobina de 5m (500cm) de longitud. Puede pedir su propia longitud personalizada cada 10,5cm
Corte a medida: ref. -XXX, donde XXX=longitud (-0105=0,105m, -1052 =1,052m ...)

LEDSTRIP COB RGB

no incl.  5mt.  DIM  24V 

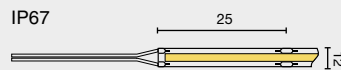
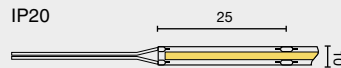
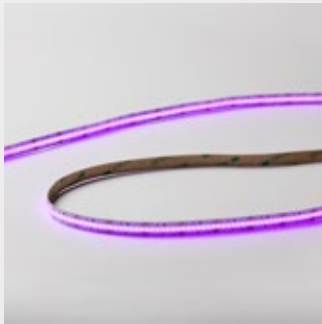

Ref	Power (W/m)	Color T°	lm output/m	IP	Cut
08050601	15W	RGB	550	20	25 mm
08050611	15W	RGB	550	67	25 mm

*Roll of 5m (500cm). You can order your own custom lenght every 10cm.
Cut to measure: ef. -XXX, where XX=length (-01 =0,1m, -02=0,2m, -14=1,4m...)

* Bobina de 5m (500cm) de longitud. Puede pedir su propia longitud personalizada cada 10cm
Corte a medida: ref. -XXX, donde XX=length (-01 =0,1m, -02=0,2m, -14=1,4m...)

LEDSTRIP RGB WHITE

NEW

no incl.  5mt.  DIM  24V 



Ref	Power (W/m)	Color T°	lm output/m	IP	Cut
08050706	24w	RGBWhite	1368	20	62mm

*Roll of 5m (500cm). You can order your own custom lenght every 10cm.
Cut to measure: ef. -XXX, where XX=length (-01 =0,1m, -02=0,2m, -14=1,4m...)

* Bobina de 5m (500cm) de longitud. Puede pedir su propia longitud personalizada cada 10cm
Corte a medida: ref. -XXX, donde XX=length (-01 =0,1m, -02=0,2m, -14=1,4m...)



**Need consulting
for your project?**
¿Necesitas
asesoramiento
para tu proyecto?



LEDSTRIP NEON FRONT

IP67 5mt. DIM

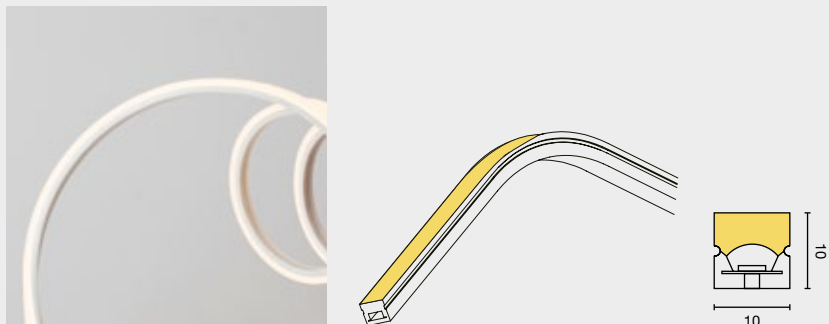

Ref	Power (W/m)	Color T°	lm output/m	IP	Cut
08045001	14W	2700K	1060	67	125mm
08046001	14W	3000K	1060	67	125mm

*Roll of 5m (500cm). You can order your own custom lenght every 125mm.
Cut to measure: ref.-XX, where XX=length. (-125 (125mm); -250 (250mm); -1000 (1000mm)...)

*Bobina de 5m (500cm). Puede pedir su propia longitud personalizada cada 125mm.
Corte a medida: ref.-XX, donde XX=longitud. (-125 (125mm); -250 (250mm); -1000 (1000mm)...)

ACCESSORIES



08040098 ALUMINIUM CLIP Clip de aluminio

LEDSTRIP NEON SIDE

IP67 5mt. DIM

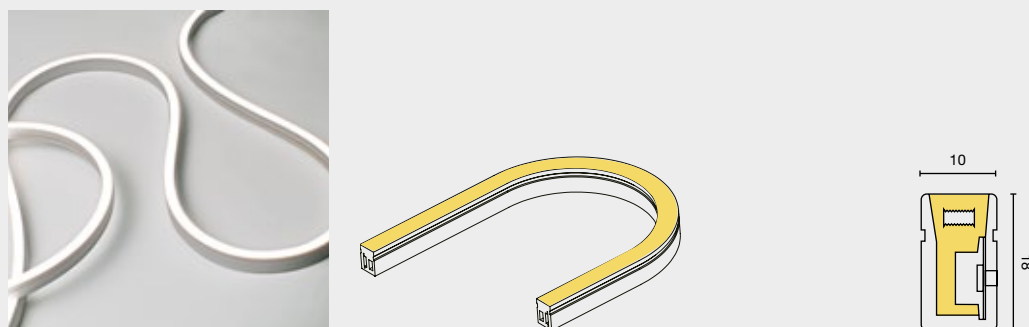

Ref	Power (W/m)	Color T°	lm output/m	IP	Cut
08047001	14W	2700K	470	67	125mm
08048001	14W	3000K	470	67	125mm

*Roll of 5m (500cm). You can order your own custom lenght every 125mm.
Cut to measure: ref.-XX, where XX=length. (-125 (125mm); -250 (250mm); -1000 (1000mm)...)

*Bobina de 5m (500cm). Puede pedir su propia longitud personalizada cada 125mm.
Corte a medida: ref.-XX, donde XX=longitud. (-125 (125mm); -250 (250mm); -1000 (1000mm)...)

ACCESSORIES



08040099 ALUMINIUM CLIP Clip de aluminio



LEDSTRIP PROFILES

SURFACE PROFILES

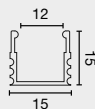
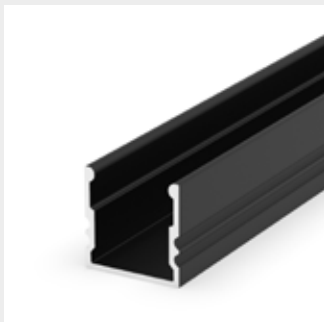

Ref	Finish	Long
08060101N	● Black	2000 mm
08060101B	○ White	2000 mm
08060101	● Silver	2000 mm

Ref	Accessorie	Finish
08060204N	End cap (2 pcs)	● Black
08060204B	End cap (2 pcs)	○ White
08060204	End cap (2 pcs)	● Silver

SURFACE PROFILES 8MM



Ref	Finish	Long
08080101N	● Black	2000 mm
08080101B	○ White	2000 mm
08080101	● Silver	2000 mm

Ref	Accessorie	Finish
08080204N	End cap (2 pcs)	● Black
08080204B	End cap (2 pcs)	○ White
08080204	End cap (2 pcs)	● Silver

SURFACE PROFILES 45°

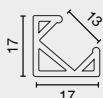
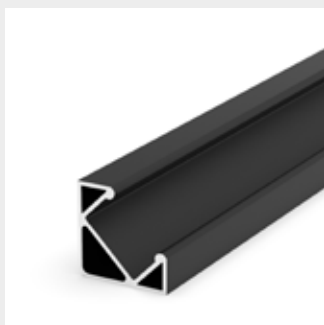

Ref	Finish	Long
08050101N	● Black	2000 mm
08050101B	○ White	2000 mm
08050101	● Silver	2000 mm

Ref	Accessorie	Finish
08050204N	End cap (2 pcs)	● Black
08050204B	End cap (2 pcs)	○ White
08050204	End cap (2 pcs)	● Silver

RECESSED PROFILES

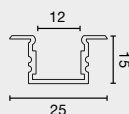
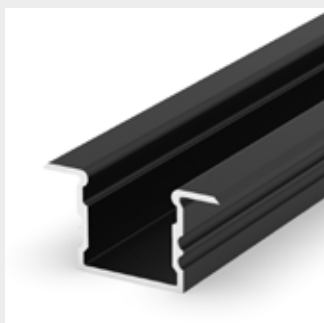

Ref	Finish	Long
08090101N	● Black	2000 mm
08090101B	○ White	2000 mm
08090101	● Silver	2000 mm

Ref	Accessorie	Finish
08070204N	End cap (2 pcs)	● Black
08070204B	End cap (2 pcs)	○ White
08070204	End cap (2 pcs)	● Silver

RECESSED PROFILES 8MM

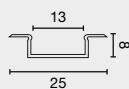

Ref	Finish	Long
08090111N	● Black	2000 mm
08090111B	○ White	2000 mm
08090111	● Silver	2000 mm

Ref	Accessorie	Finish
08090204N	End cap (2 pcs)	● Black
08090204B	End cap (2 pcs)	○ White
08090204	End cap (2 pcs)	● Silver

OPAL DIFFUSER



Ref	Long
0806202	2000 mm

TRANSPARENT DIFFUSER

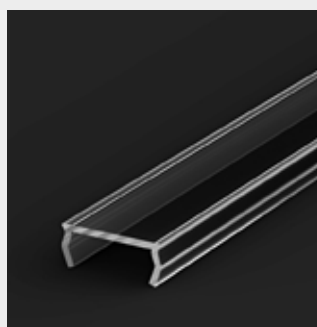

Ref	Long
0806203	2000 mm

CLIPS



08050105 ● Surface profile clip 45°



08060105 ● Surface & 15mm recessed clip



Light Colour
Control de luz



Sunrise & Sunset
Amanecer y atardecer



Calendar & Timer
Calendario y Temporizador



Colour Color T°
Color Color T°



Grouping
Agrupación



Scenes
Escenas



Animations
Animaciones



Gallery
Galería



Daylight Sensor
Sensor de luz diurna



Occupancy Sensor
Sensor de ocupación

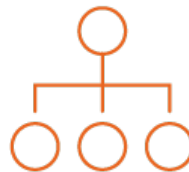

Control Hierarchy
Jerarquía de control

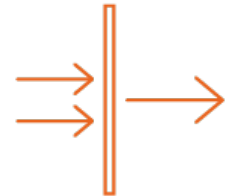

Gateway
Entrada

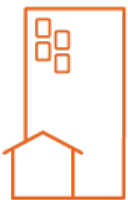

Scalability
Escalabilidad



Synchronization
Sincronización



Elements
Elementos



Parameters
Parámetros

This range of control elements offers customized solutions to optimize specific environments. Easily create dynamic spaces and energy efficient through control of lighting.



CASAMBI
SMART
LIGHTING

Esta gama de elementos de control ofrece soluciones personalizadas para optimizar entornos específicos. Crea fácilmente espacios dinámicos y eficientes desde el punto de vista energético mediante el control de la iluminación.

Switch & Controls

Switch for CASAMBI installations control



97534

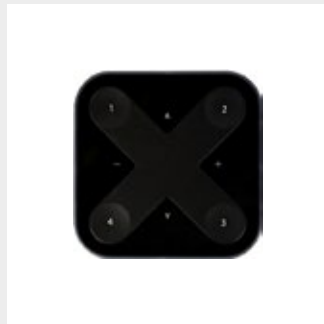

97533

Allows dimming, calling scenes, controlling groups, all lamps and sequences. Works with Casambi APP and Casambi Models. Black or white colour. Lithium CR2430 battery, duration 2-5 years. Open range 60 metres. 4 general purpose buttons (scenes, individual, groups, sequences) plus 2 regulation buttons and 2 other buttons programmable by the Casambi APP.

Permite regular, llamar a escenas, controlar grupos, todas las lámparas y secuencias. Funciona con la APP de Casambi y Modelos Casambi. Color negro o blanco. Pila CR2430 de Litio, duración 2-5 años. Alcance en abierto 60 metros. 4 botones de propósito general (escenas, individual, grupos, secuencias) más 2 botones de regulación y otros 2 botones programables por la APP de Casambi.

Switch 55



97536 Matt Anthracite Antracita Mate

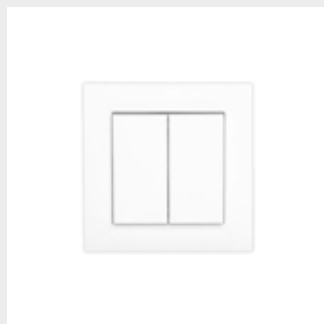

97537 Matt White Blanco Mate

4-channel bluetooth wireless push button with 2 keys. Completely autonomous (no battery or power supply), it works by mechanical impulses. It sends a radio signal thanks to the energy released when the keys are pressed and requires no maintenance.

Pulsador inalámbrico bluetooth de 4 canales mediante 2 teclas. Completamente autónomo (sin pila ni alimentación), funciona mediante impulsos mecánicos. Envía una señal de radio gracias a la energía liberada durante las pulsaciones de las teclas y no requiere mantenimiento.

Sensors

Recessed Sensor



97542

Surface Sensor



97543

Bluetooth light level and presence sensor in recessed or surface format. Through the CASAMBI App, it can be configured to activate scenes, luminaires, when it detects presence, according to illuminance or circadian scenes. Recommended installation height between 2.4 and 5m. Detection diameter between 5 and 7m.

Sensor bluetooth de nivel de luz y presencia en formato de empotrar o superficie. A través de la App de CASAMBI se puede configurar para activar escenas, luminarias, cuando detecte presencia, según la iluminancia o escenas circadianas. Altura de instalación recomendada entre 2,4 y 5m. Diámetro de detección entre 5 y 7m.

Auxiliary Devices

CBU-DCS Bluetooth DALI controller



97530

CBU-DCS is a Bluetooth controllable, Casambi enabled DALI controller. CBU-DCS does not have its own power supply. Instead, it is powered directly from a DALI bus.

CBU-DCS es un controlador DALI controlado por Bluetooth y habilitado por Casambi. CBU-DCS no tiene su propia fuente de alimentación. En su lugar, se alimenta directamente de un bus DALI.

Dimming for LED strips



97538

Dimming by CASAMBI for LED strips. 4 output channels. Max. total current 6 Ampere. Without push button input.

Regulación por CASAMBI para tiras LED. 4 canales de salida. Corriente máxima en total 6 Amperios. Sin entrada de pulsador.

CASAMBI to DALI converter



97531

Built-in 120mA DALI source. Broadcast output, 4 groups, DT8 or RGBW. To control up to 60 DALI luminaires all at the same time.

Fuente DALI integrada de 120mA. Salida en Broadcast, 4 grupos, DT8 o RGBW. Para controlar hasta 60 luminarias DALI todas a la vez.

Casambi Repeater Module



97532

With this module the range of the Bluetooth signal can be easily increased. Con este módulo se puede aumentar fácilmente el alcance de la señal Bluetooth.

Plug & Play – Switch



97540

Smart plug adapter for luminaires and electrical appliances. High switching capacity – up to 3680 W.

Adaptador de enchufe inteligente para luminarias y aparatos eléctricos. Gran capacidad de conmutación: hasta 3680W.



97541

Timer-Casambi



97544

TIMER-CASAMBI is a device that allows to keep memory of Casambi timers for scenarios when power supply is missing or because of a temporarily black-out. TIMER-CASAMBI es un dispositivo que permite mantener la memoria de los temporizadores Casambi para los escenarios en los que falta la alimentación eléctrica o debido a un apagón temporal.

Casambi PWM4 IP65



97539

IP65 CBU-PWM4. CBU-PWM4 en formato IP65.

Dali elements

Dali Touchpanel Basic C



97545

Capacitive touch panel with glass screen. Allows switching on, off and dimming of up to 3 groups or scenes of luminaires. Powered by DALI bus.

Panel táctil capacitivo con pantalla de cristal. Permite el encendido, apagado y regulación de hasta 3 grupos o escenas de luminarias. Alimentación por bus DALI.

Dali Touchpanel Basic TW



97546

Allows easy control of Tuneable White luminaires via DALI protocol. Permite controlar fácilmente las luminarias Tuneable White mediante protocolo DALI.

Dali USB Programmer



97547

USB interface module for DALI system. Accessory for connecting software tools for addressing, programming and parameterisation of DALI installations and Faro Barcelona devices.

Módulo interfaz USB para sistema DALI. Accesorio para conectar herramientas software para direccionamiento, programación y parametrización de instalaciones DALI y dispositivos Faro Barcelona.

Dali PS1 Power Supply



97548

4W DALI power supply for stand-alone mounting, Accessory for supplying 200mA to DALI devices or control modules without their own standard power supply. Powered at 230-240V; 50/60Hz.

Alimentador DALI de 4W para montaje independiente, Accesorio para suministrar 200mA a dispositivos DALI o módulos de control sin su propia fuente de alimentación estándar. Alimentado a 230-240V; 50/60Hz.

Recessed Dali Sensor



97549

Light level and presence sensor using DALI protocol. Recessed and surface mounting format. Allows simple switching on, switching off and dimming of individual luminaires, groups of luminaires or scenes, either by presence or brightness detection. Power supply via DALI bus.

Sensor de nivel de luz y presencia mediante protocolo DALI. Formato de empotrar y superficie. Permite encender, apagar y regular de forma simple luminarias individuales, grupos de luminarias o escenas, ya sea por detección de presencia o luminosidad. Alimentación mediante Bus DALI.

Surface Dali Sensor



97550

Today's technology makes it possible to integrate thousands of luminaires and control functions into a single system based on a DALI control network or even centralise it in a BMS system. At Faro Barcelona we have concentrated all our experience and knowledge on simple solutions helping to find the necessary control elements to customise an installation.

Despite the complexity and size of the lighting installations, only a few components are needed to manage the entire system: Luminaires with DALI driver, DALI sensors (multisensors), DALI pushbuttons, DALI buttons, DALI Bus feeder and routers as a control unit.

La tecnología actual permite integrar miles de luminarias y funciones de control en un solo sistema basado en una red DALI de control o incluso centralizarlo en un sistema BMS. En Faro Barcelona hemos concentrado toda nuestra experiencia y conocimientos en soluciones simples ayudando a encontrar los elementos de control necesarios para personalizar una instalación.

A pesar de la complejidad y el tamaño de las instalaciones de iluminación, solo se necesitan algunos componentes para gestionar todo el sistema: Luminarias con driver DALI, sensores (multisensores) DALI, pulsadores DALI, botonas DALI, alimentador de Bus DALI y routers como unidad de control.

DALI and DALI-2 are open lighting standards. It is a digital protocol used worldwide to control lighting components, it allows to transfer information such as lighting commands, fault data, consumption and diagnostics between different devices.



SMART LIGHTING

DALI y DALI-2 son estándares abiertos de iluminación. Es un protocolo digital usado en todo el mundo para controlar componentes de iluminación, permite transferir información como los comandos de iluminación, los datos de fallos, consumos y los diagnósticos entre distintos dispositivos.

Recommended Drivers













Driver	Model	Control System	Power	mA	Units
98310235	TROOP	ON/OFF 220-240V	2W	700mA	1-15 units
98310210	TROOP	TRIAC	2W	700mA	2-4 units
98310235D	TROOP	DALI	2W	700mA	1-15 units
98310538	TROOP	CASAMBI	2W	700mA	4-16 units
98310235	TROOP	ON/OFF 220-240V	3x2W	700mA	1-5 unit
98310220LC	TROOP	TRIAC	3x2W	700mA	2-3 units
98310235D	TROOP	DALI	3x2W	700mA	1-5 units
98310538	TROOP	CASAMBI	3x2W	700mA	2-5 units
98310235	TROOP	ON/OFF 220-240V	5x2W	700mA	1-3 units
98310210	TROOP	TRIAC	5x2W	700mA	1 unit
98310235D	TROOP	DALI	5x2W	700mA	1-3 units
98310538	TROOP	CASAMBI	5x2W	700mA	1-3 units
98310235	TROOP	ON/OFF 220-240V	10x2W	700mA	1 unit
98310236C	TROOP	TRIAC	10x2W	700mA	1 unit
98310235D	TROOP	DALI	10x2W	700mA	1 unit
98310538	TROOP	CASAMBI	10x2W	700mA	1 unit
98310620	NANO COLIN	ON/OFF	7W	200mA	1 unit
98310509C	NANO COLIN	TRIAC	7W	200mA	1 unit
98310136	NANO COLIN	ON/OFF	13W	350mA	1 unit
98310114C	NANO COLIN	TRIAC	13W	350mA	1 unit
98310136D	NANO COLIN	DALI	13W	350mA	1 unit
98310538	NANO COLIN	CASAMBI	13W	350mA	1 unit
98310336	MINI COLIN	ON/OFF	18W	500mA	1 unit
98310321 LC	MINI COLIN	TRIAC	18W	500mA	1 unit
98310336D/98310235D	MINI COLIN	DALI	18 / 25W	500 / 700mA	1 unit
98310538	MINI COLIN	CASAMBI	18 / 25W	500 / 700mA	1 unit
98310235	MINI COLIN	ON/OFF	25W	700mA	1 unit
98310236C	MINI COLIN	TRIAC	25W	700mA	1 unit
98310235	COLIN	ON/OFF	24W	700mA	1 unit
98310236C	COLIN	TRIAC	24W	700mA	1 unit
98310235D/98310536	COLIN	DALI	24 / 36W	700 / 1050mA	1 unit
98310538	COLIN	CASAMBI	24 / 36W	700 / 1050mA	1 unit
98310444	COLIN	ON/OFF 100-240V	36W	1050mA	1 unit
98310321 LC	COLIN	TRIAC	18W	1050mA	1 unit
98111020	COLIN QR-111	ON/OFF 220-240V	20w	12 V	1 lamp.
98312070	COLIN QR-111	TRIAC	70w	12 V	max.4 lamp.

Driver	Model	Control System	Power	mA	Units
98310336	OPTIC MINI	ON/OFF	18W	500mA	1-15 units
98310321 LC	OPTIC MINI	TRIAC	18W	500mA	2-4 units
98310336D/98310235D	OPTIC MINI	DALI	18 / 25W	500 / 700mA	1-15 units
98310235	OPTIC MINI	ON/OFF	25W	700mA	4-16 units
98310236C	OPTIC MINI	TRIAC	25W	700mA	1-5 unit
98310538	OPTIC MINI	CASAMBI	18 / 25W	500 / 700mA	2-3 units
98310235	OPTIC	ON/OFF	24W	700mA	1-5 units
98310236C	OPTIC	TRIAC	24W	700mA	2-5 units
98310235D/98310536	OPTIC	DALI	24 / 36W	700 / 1050mA	1-3 units
98310538	OPTIC	CASAMBI	24 / 36W	700 / 1050mA	1 unit
98310444	OPTIC	ON/OFF 100-240V	36W	1050mA	1-3 units
98310321 LC	OPTIC	TRIAC	18W	1050mA	1-3 units
98310637	DEEP S	ON/OFF 220-240V	6W	200mA	1 unit
98310509C	DEEP S	TRIAC	6W	200mA	1 unit
98310136	DEEP S	ON/OFF 220-240V	11W	350mA	1 unit
98310114C	DEEP S	TRIAC	11W	350mA	1 unit
98310136D	DEEP S	DALI	11W	350mA	1 unit
98310538	DEEP S	CASAMBI	11W	350mA	1 unit
98310136	DEEP M	ON/OFF 220-240V	12W	350mA	1 unit
98310114C	DEEP M	TRIAC	12W	350mA	1 unit
98310336	DEEP M	ON/OFF 220-240V	18W	500mA	1 unit
98310321 LC	DEEP M	TRIAC	18W	500mA	1 unit
983100136D//98310336D	DEEP M	DALI	12 / 18W	350/500mA	1 unit
98310538	DEEP M	CASAMBI	12 / 18W	350/500mA	1 unit
98310336	DEEP L	ON/OFF 220-240V	18W	500mA	1 unit
98310321 LC	DEEP L	TRIAC	18W	500mA	1 unit
98310235	DEEP L	ON/OFF 200-240V	25W	700mA	1 unit
98310236C	DEEP L	TRIAC	25W	700mA	1 unit
98310444	DEEP L	ON/OFF 100-240V	39W	1050mA	1 unit
98310336D/98310235D/98310536	DEEP L	DALI	18 / 25 / 39W	500/700/1050mA	1 unit
98310538	DEEP L	CASAMBI	18 / 25 / 39W	500/700/1050mA	1 unit

24V Power Supply

98324012	Constant voltage power supply for 24V DC. Supplies up to 12W, 220-240V, 50/60Hz	Fuente de alimentación de voltaje constante para 24V DC. Suministra hasta 12W, 220-240V, 50/60Hz	
98324026	Constant voltage power supply for 24V DC. Supplies up to 26W, 220-240V, 50/60Hz. With protection rated at IP67	Fuente de alimentación de voltaje constante para 24V DC. Suministra hasta 26W, 220-240V, 50/60Hz. Con protección clasificada en IP67	
98324030	Constant voltage power supply for 24V DC. Supplies up to 30W, 220-240V, 50/60Hz	Fuente de alimentación de voltaje constante para 24V DC. Suministra hasta 30W, 220-240V, 50/60Hz	
98324031	Constant voltage power supply for 24V DC. Supplies up to 30W, 220-240V, 50/60Hz. With protection rated at IP67	Fuente de alimentación de voltaje constante para 24V DC. Suministra hasta 30W, 220-240V, 50/60Hz. Con protección clasificada en IP67	
98324060	Constant voltage power supply for 24V DC. Supplies up to 60W, 220-240V, 50/60Hz	Fuente de alimentación de voltaje constante para 24V DC. Suministra hasta 60W, 220-240V, 50/60Hz	
98324099	Constant voltage power supply for 24V DC. Supplies up to 100W, 220-240V, 50/60Hz	Fuente de alimentación de voltaje constante para 24V DC. Suministra hasta 100W, 220-240V, 50/60Hz	
98324100	Constant voltage power supply for 24V DC. Supplies up to 100W, 220-240V, 50/60Hz. With protection rated at IP67	Fuente de alimentación de voltaje constante para 24V DC. Suministra hasta 100W, 220-240V, 50/60Hz. Con protección clasificada en IP67	
98324120	Constant voltage power supply for 24V DC. Supplies up to 120W, 220-240V, 50/60Hz	Fuente de alimentación de voltaje constante para 24V DC. Suministra hasta 120W, 220-240V, 50/60Hz	
98324150	Constant voltage power supply for 24V DC. Supplies up to 160W, 220-240V, 50/60Hz	Fuente de alimentación de voltaje constante para 24V DC. Suministra hasta 160W, 220-240V, 50/60Hz	
98324150D	Constant voltage power supply for 24V DC. Supplies up to 150W, 220-240V, 50/60Hz. Dali	Fuente de alimentación de voltaje constante para 24V DC. Suministra hasta 150W, 220-240V 50/60Hz. Dali	
98324151	Constant voltage power supply for 24V DC. Supplies up to 150W, 220-240V, 50/60Hz. With protection rated at IP67	Fuente de alimentación de voltaje constante para 24V DC. Suministra hasta 150W, 220-240V, 50/60Hz. Con protección clasificada en IP67	
98324200	Constant voltage power supply for 24V DC. Supplies up to 200W, 220-240V, 50/60Hz.	Fuente de alimentación de voltaje constante para 24V DC. Suministra hasta 200W, 220-240V, 50/60Hz. Con protección clasificada en IP67	

Simbology

	Luminaires of insulation class I are provided with a connection for the earthing conductor (PE) and are not specially marked.	Las luminarias de la clase de aislamiento I están provistas de una conexión para el conductor de puesta a tierra (PE) y no están identificadas de forma especial.
	Luminaires with insulation class II	Luminarias con clase de aislamiento II
	Luminaires with insulation class III	Luminarias con clase de aislamiento III
 incl.	Driver included	Equipo electrónico incluido
 no incl.	Driver not included	Equipo electrónico no incluido
 2mt.	Cable meters	Metros de cable
 50.000hs L80/B10	LED lifetime	Vida útil LED
 20°	Cardanic orientation	Orientación cardánica
 355°	Vertical orientation degrees	Grados de orientación vertical
 355°	Horizontal orientation degrees	Grados de orientación horizontal
 30°	Vertical orientation degrees	Grados de orientación vertical
 30°	Vertical orientation degrees	Grados de orientación vertical
 850°C	Compliance of incandescent wire regulatory	Cumplimiento de la normativa incandescente de alambre.
	Cut out	Agujero para empotrar
	MacAdam ellipses	Elipses de MacAdam
	Dimmers are devices used to vary the brightness of a light.	Los Dimmers son dispositivos utilizados para variar la intensidad de la luz.
	Tunable White. Luminaires with variable colour temperature control from warm white to cool white.	Tunable White. Luminarias con control variable de la temperatura de color desde la luz blanca cálida hasta el blanco frío.
	Unified Glare Rating	Unified Glare Rating Índice de Deslumbramiento Unificado

TRUE BEAUTY
RESIDES
IN SIMPLICITY.
IN EVERY SMALL
MOMENT WE
DISCOVER
THE EXTRAORDINARY.